

CATALOGUE

SURGICAL INSTRUMENTS

Serving Your Health With Excellence



Dear Valuable Customer,

Medicrest Surgical Industries is a leading manufacturer and supplier of all kinds of single use and reusable Surgical Instruments to worldwide. All of our instruments are ISO 9001:2016, ISO 13485:2016 and CE mark certified in accordance with the Medical Devices Directive. We also provide OEM services to the customers.

Having our manufacturing unit in Sialkot (Pakistan), world's renowned city for the manufacturing of surgical instruments. We worked hard to build our reputation in this evolving industry and our satisfied customers are our strength. Our products are manufactured using the best quality stainless steel as **AIS'**, **ASTM** and **DIN** standard's recommended which is imported from **Germany, Japan and France**. The key to our success is our quality assurance. We use the right material for the right products.

Medicrest Surgical Industries prices are very competitive and very flexible with customers provide maximum co-operation. Our company's motto is to keep customers satisfy because your satisfaction is our business.

If you would like to get our price list, interested to see our samples for quality assessment or want to get more information about our quality products, please feel free to contact us for any information.

Thanks and Best Regards

CEO

Medicrest Surgical Industries

Manufacturing Capabilities:

All of Our production departments are well equipped with the latest, machinery which is imported from Germany and England, and well-staffed with the expert technicians.

Raw Material Department:

Medicrest Surgical Industries always purchases best quality stainless steel raw material from steel manufacturers or import directly from Japan. France and Germany when need to do so. Two kinds of series i.e. 304, 410 and 420 Of stainless steel are used for production of Surgical Instruments. At Medicrest Surgical, we believe that quality can only be achieved through quality raw material. As such, the best quality Raw-materials (Stainless Steel Strips, Round Bars, Stainless Steel Coils and Stainless Steel Tubes) are purchased and are subjected to composition and hardness testing through our in-house laboratory in order to ensure that only the best materials are passed on to production departments.

Forging Department:

Medicrest Surgical has its own forging section where forgings are made through Drop Hammer process by seasoned operators using dyes made of the best quality imported D-2 Steel. Forging is done by keeping in mind that the geometry of this process is a starting point and does not on any way limit your design freedom.

Milling Department:

Milling is used in the surgical instruments industry, defined as the process of cutting, shaping and finishing of an instrument. It is the process that includes turning, welding and fringing. At Medicrest Surgical we use the best milling technology which involves cutting away pieces of metal to create dovetails, threads, bevels, slots and ridges

Grinding: (Filing & Setting)

In order to give a final shape to the instrument, our highly skilled craftsman use filing and grinding processes which removes the material from the instrument by abrasion. Then the instrument is keenly observed and set to perform perfect.

Hardness Test (Heat Treatment):

For surgical instruments, the term harness refers to the resistance to bending, scratching, abrasion or cutting. We have in-house Heat Treatment Department equipped with top quality Vacuum Furnace where qualified staff and engineers are engaged in treating the instruments in order to add strength to the steel and perfect the metallurgical composition for further processes.

Polishing Department:

The Electro-Polishing Department is manned by seasoned workmen using imported chemicals and best quality grinding wheels to ensure the best quality finish. In this department, the instruments are given final finish which includes mirror, satin or matt finishes. The finish is per customers' requirements.

Tungsten Carbide Department:

Medicrest Surgical's tungsten carbide department is installed with the best quality imported machinery being manned by the exceptionally well trained experts using the German Technology. We use German tungsten carbide tips for our instruments.

Coating Department:

Our coating department is capable of providing gold plated instruments as well as powder coated instruments depending upon the requirements of the instruments or the customers. Best quality coating related raw materials are used so that no compromise can be made on quality. Furthermore, each coating is inspected for quality before any instrument is passed on to the next department.

Passivation Department:

We use high quality imported chemicals in our passivation Department. Every instrument is boil test and passivate for 24 hours before packing. If need arises, the instruments are re-passivated so as to eliminate any chances of rusting or corrosion during the life of the instrument. Our instruments are rust-free for life though we give guarantee for five years.

Sandblasting Department:

For sandblasting our instruments, we use the machines as well as the best quality sandblasting material which are operated by skilled & well trained operators.

Stamping/Etching:

We use permanent and long life high quality laser etching which produces a wide variety of text and graphic images including our customer's logo with very detailed and fine image quality.

Quality Control:







Our quality control department is involved at all of the processes of manufacturing but before the instrument goes to the packing department, its quality and function is thoroughly checked by our qualified engineers.





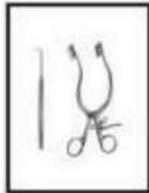

Labeling and packing:



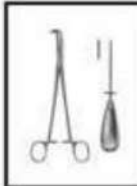

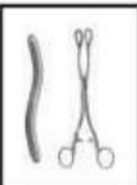
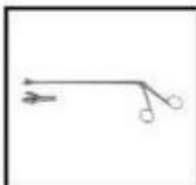

Each instrument is initially packed in a poly bag to prevent scratches and then packed in the middle box. Middle boxes are then packed in the carton. The middle boxes are labeled which includes the article number, types and sizes of instruments. We can also arrange packaging and labeling according to the customer's demand.

Warehouse:

After the instruments are packed and labeled, cartons are then move to our house warehouse where the complete record of shipments are maintained by our qualified warehouse management.

	DESCRIPTION	SECTION	PAGE #	
01:	Diagnostic, Anaesthesia, Scalpels & Knives	01	1 - 22	
02:	Scissors	02	23 - 51	
03:	Forceps, Clamps	02	52 - 95	
04:	Needle Holders, Micro Needle Holders	02	96 - 101	
05:	Suture Instruments, Needles, Probes, Applicators, Pocket Instruments Set.	02	102 - 114	
06:	Hooks, Retractors, Spatulas, Spreaders, Abdominal Retractors	03	115 - 167	
07:	Forceps, Intestinal Clamps, Specula, Biopsy Forceps, Anuscopes	03	168 - 193	

DESCRIPTION	SECTION	PAGE #	
08: Gall Duct Forceps / Probes / Scissors / Kidney Forceps, Urinary Instruments, Trocars	03	194 - 208	
09: Vaginal Specula & Retractors	04	209 - 220	
10: Utrine Dilators, Probes, Forceps, Myoma Instruments	04	221 - 236	
11: Biopsy Instruments, Utrine Curettes / Scoops	04	237 - 245	
12: Obstetrics Instruments	04	246 - 254	
13: Tracheotomy, Cardiovascular & Thoracic Surgery	05	255 - 309	
14: Bone Punches & Rongeurs	05	310 - 318	

DESCRIPTION	SECTION	PAGE #	
15: Amputation, Elevators, Saws, Raspatories, Bone Livers, Bone Files & Curettes	06	319 - 347	
16: Mallets, Tampers, Chisels, Gauges, Bone Holding Forceps, Bone Rongeurs, Bone Cutting Forceps, Meniscus Instruments	06	348 - 379	
17: Wire Extension, Finger Nail Instruments	06	380 - 392	
18: Plaster Instruments	07	393 - 397	
19: Suction Instruments	07	398 - 404	
20: TUNGSTEN CARBIDE INSERTS	07	405 - 421	
21: HOSPITAL WARES	07	422 - 432	

Section - 01



Pages 01 - 22

- ★ Diagnostic
- ★ Anaesthesia
- ★ Scalpels
- ★ Knives



01-2001
TROEMNER
Size: 245 mm



01-2002
DEJERINE
Size: 200 mm



01-2003
DEJERINE
With Needle
Size: 210 mm



01-2004
TAYLOR
Size: 195 mm



01-2005
BERLINER
Size: 200 mm



01-2006
BUCK
With Needle
And Brush
Size: 180 mm



01-2007
RABINER
With Needle
And Brush
Size: 255 mm



01-2008
ALY
Size: 190 mm



01-2009
WARTENBERG
Pinwheel For
Neurological
Examination
Size: 185 mm



01-2010
PINARD
of aluminium
Size: 155 mm



01-2011
aus Holz
Wooden
Size: 145 mm



01-2012
BOWLES
Stethoscope With
Diaphragm,
In Plastic Pouch



01-2013
ANESTOPHON
Ø47mm



01-2014
FORD-BOWLES
Combination Stethoscope
With Diaphragm and Bell
Dual Chest Piece
With Two Outlets



01-2015
BOWLES
Stethoscope With
Diaphragm,
Flat Model,
Suitable Also
For Anaesthesia
Chest Piece Only
40 mm Diam





01-2016
ZIEGLER Ø 90mm
Head mirror only
with rubber coating



01-2017
ZIEGLER Ø 90mm
Head mirror only
with metal coating



01-2018
ZIEGLER
Head band of plastic, black only

01-2019
ZIEGLER
Head band of plastic, white only



01-2020
MURPHY
Head band of celluloid, white only



01-2021
Head band of plastic,
white, soft pattern



01-2022
Head mirror
with black plastic head
band



01-2026
spare bulb

01-2023
CLAR
Head light, 6 volt, with adjustable joint, white celluloid head band, cord with plugs for transformer

01-2024
White celluloid head band, only, for **01-2023**

01-2025
Spare mirror only, for **01-2023**



01-2027
CLAR
Head light, 6 volt, with adjustable joint, white celluloid head band, with foam rubber pad and cord with plugs for transformer

01-2028
White celluloid head band, only, for head light

01-2029
mirror only, for head light

01-2030
spare foam rubber pad, for head band



01-2033
spare bulb

01-2032
JANSEN
Head light, 6 volt, with adjustable joint, white plastic head band, cord with plugs for transformer



01-2034
LANGENBECK
Head light, 3.7 volt, with adjustable joint, white plastic head band, cord with plugs for transformer

01-2035
spare bulb



01-2036
HERBERHOLD
Pocket-Accu, 6 volts, with cord for head lights



01-2037
Extension cord only, to connect the accu to the cord of the head lights



01-2038
Charging Set for pocket accu **01-2036**
mains current: 220-240 volts, 50-60 Hz



01-2039
220 volt / 220 volts
01-2040
120 volt / 120 volts
Transformer

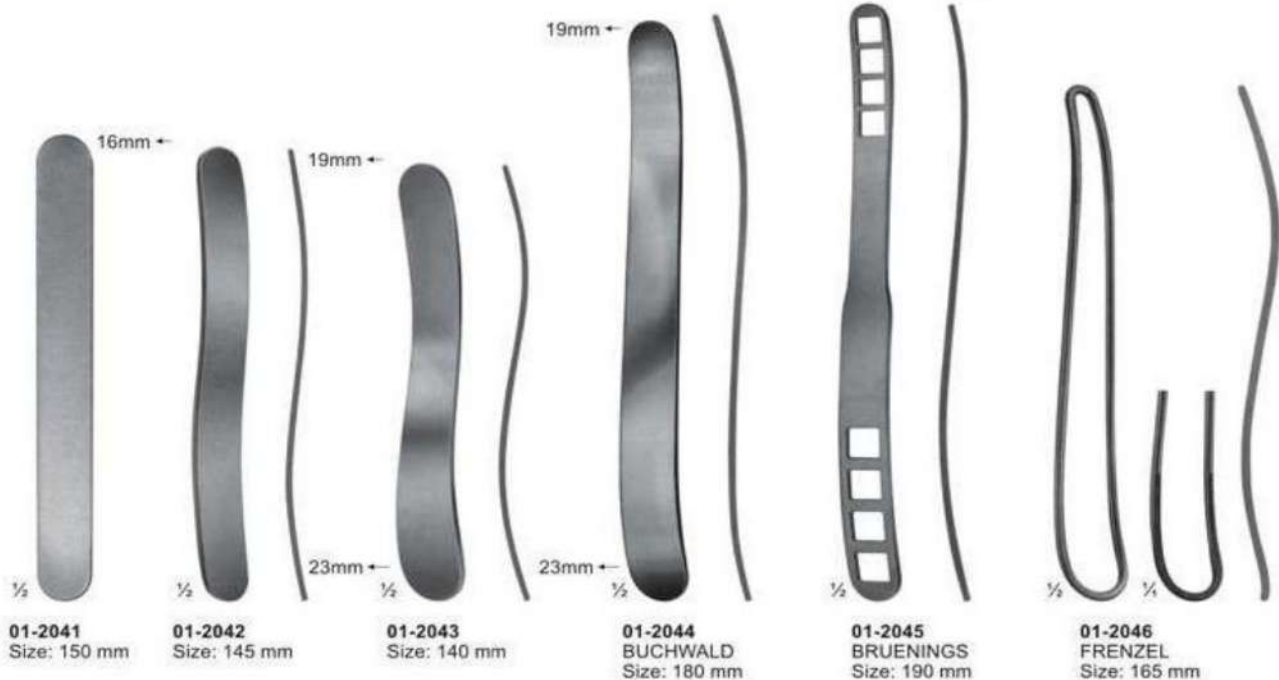



1/2
01-2055
SCHIMMELBUSCH
Ether Mask



1/2
01-2056
HEISTER
Mouth Gag
Size: 130 mm



1/2
01-2057
FERGUSSON-ACKLAND
Mouth Gag
Size: 145 mm



1/2
01-2058
DENHARDT
Mouth Gag With
Silicon Inserts,
Interchangeable
Size: 125 mm



1/2
01-2059-01-2060
ROSER KOENIG
Mouth Gag
Size: **01-2059** 160mm
01-2060 185mm

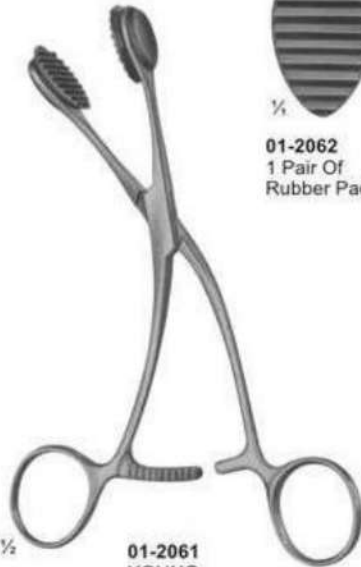

1/2
01-2061
YOUNG
Size: 165 mm



1/4
01-2062
1 Pair Of
Rubber Pads



1/2
01-2063-2064
COLLIN



1/4
01-2063
Size: 160 mm



1/4
01-2064
Size: 170 mm

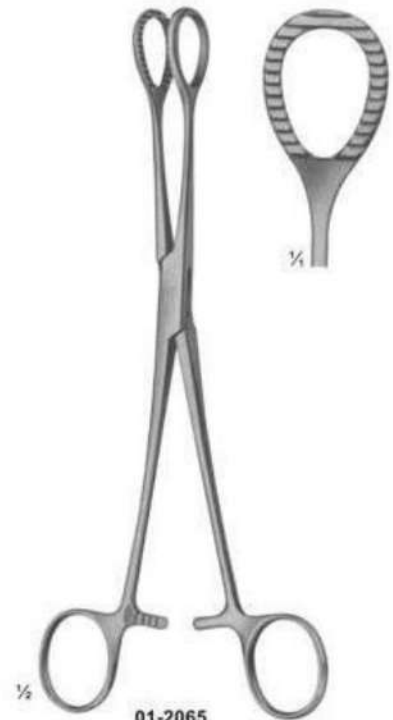

1/2
01-2065
HEYWOOD-SMITH modif.
Size: 215 mm

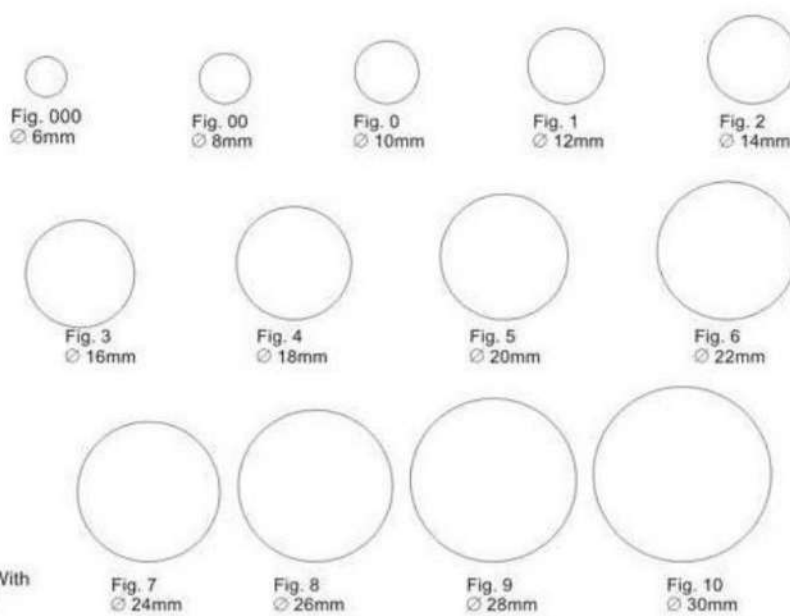



1/2

01-2074 - 01-2076
MAGILL
Catheter Introducing
Forceps



01-2074
Infants
Size: 150 mm



01-2075
Children
Size: 200 mm



01-2076
Adults
Size: 250 mm



1/2

01-2077
Medium battery handle
only, 25 mm diam.



01-2078
Spare bulb
2.7 volt, for
Otosopes etc.



01-2079
Spare bulb
2.6 volt, for
ophthalmoscopes



01-2080
Otoscope Set, Consists Of
Battery Handle Without Batteries,
3 Ear Specula, 1 Bulb In Valvet Lined Case



01-2081
Diagnostic Set, Otoscope With Three Specula,
Nasal Speculum, Lamp Holder, Two Laryngeal
Mirrors, Tongue Blade Holder



01-2082
MILLER
 Laryngoscope Set, Consists Of Battery Handle (Without Battery)
 With Five Miller Laryngoscope Blades, Fig 1 to 5



01-2082 A Fig. 0 Working Length, 55 mm (Baby's) $\frac{1}{2}$
01-2082 B Fig. 1 Working Length, 80 mm (Children's)
01-2082 C Fig. 2 Working Length, 130 mm (Adolescent's)
01-2082 D Fig. 3 Working Length, 170 mm (Women's)
01-2082 E Fig. 4 Working Length, 180 mm (Men's)



01-2083
GUEDEL-NEGUS
 Laryngoscope Set, Consists Of Battery Handle (Without Battery)
 With Four Miller Laryngoscope Blades



01-2083 A Fig. 1 Working Length, 70 mm (Children's)
01-2083 B Fig. 2 Working Length, 90 mm (Adolescent's)
01-2083 C Fig. 3 Working Length, 110 mm (Women's)
01-2083 D Fig. 4 Working Length, 135 mm (Men's)



01-2084
McINTOSH
Laryngoscope Set, Consists Of Battery Handle (Without Battery)
With Three McIntosh Blades, Fig. 1, Fig. 2, Fig. 3

01-2085
McINTOSH
Laryngoscope Set, Consists Of Battery Handle (Without Battery)
With Five McIntosh Blades, Fig. 0, Fig. 1, Fig. 2, Fig. 3, Fig. 4



01-2086
FOREGGER
Laryngoscope Set, Consists Of
Battery Handle (Without Battery)
With Three Foregger Blades,
Fig. 1, Fig. 2, Fig. 3,

01-2087
FOREGGER
Laryngoscope Set, Consists Of
Battery Handle (Without Battery)
With Four Foregger Blades,
Fig. 1, Fig. 2, Fig. 3, Fig. 4,

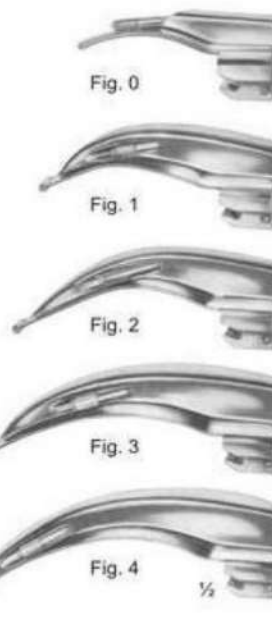

01-2085 A Fig. 0 Working Length, 55 mm (Baby's)
01-2085 B Fig. 1 Working Length, 75 mm (Children's)
01-2085 C Fig. 2 Working Length, 90 mm (Adolescent's)
01-2085 D Fig. 3 Working Length, 110 mm (Women's)
01-2085 E Fig. 4 Working Length, 135 mm (Men's)

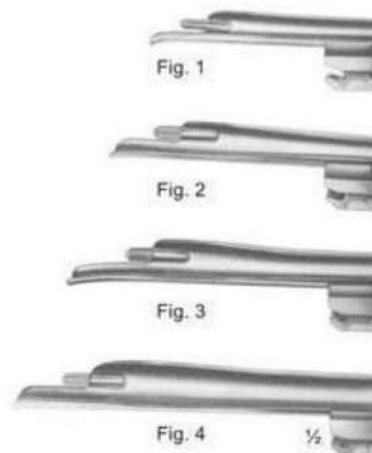

01-2086 A Fig. 1 Working Length, 70 mm (Children's)
01-2086 B Fig. 2 Working Length, 90 mm (Adolescent's)
01-2086 C Fig. 3 Working Length, 110 mm (Women's)
01-2086 D Fig. 4 Working Length, 135 mm (Men's)

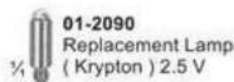



01-2092
Caliper Of Aluminium
Graduated in mm & inches
up to 180mm
Measuring Range up to 139mm



01-2093
VERNIER
Universal Caliper Of Steel
Graduated in mm & inches
up to 180mm
Measuring Range up to 120mm
with Vernier in 1/10mm & 1/16"



01-2094
CARROLL
Size: 145 mm
Finger Goniometer



01-2095
TOWNLEY
Graduated in
mm & inches
Size: 115 mm



01-2096
COLLIN
Druck Pressure 72 kg
Size: 125 mm



01-2097
BERTILLON
Caliper For Measuring The Head
Size: 320 mm



01-2098
CASTROVIEJO
Caliper
Size: 75mm



01-2099
MOLTGEN
Goniometer

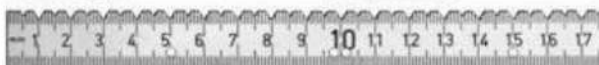

01-2100A
Size: 150 mm



01-2100
Size: 500 mm





01-2101 - 01-2110
Fig. 1 - 10
With Metal Handle



01-2101
Fig. 1
Size: 30mm
15cm



01-2102
Fig. 2
Size: 36mm
15cm



01-2103
Fig. 3
Size: 40mm
15.5cm



01-2104
Fig. 4
Size: 45mm
16cm



01-2105
Fig. 5
Size: 50mm
16cm



01-2106
Fig. 6
Size: 27mm
15cm



01-2107
Fig. 7
Size: 35mm
15cm



01-2108
Fig. 8
Size: 40mm
16cm



01-2109
Fig. 9
Size: 47mm
16cm



01-2110
Fig. 10
Size: 50mm
17cm



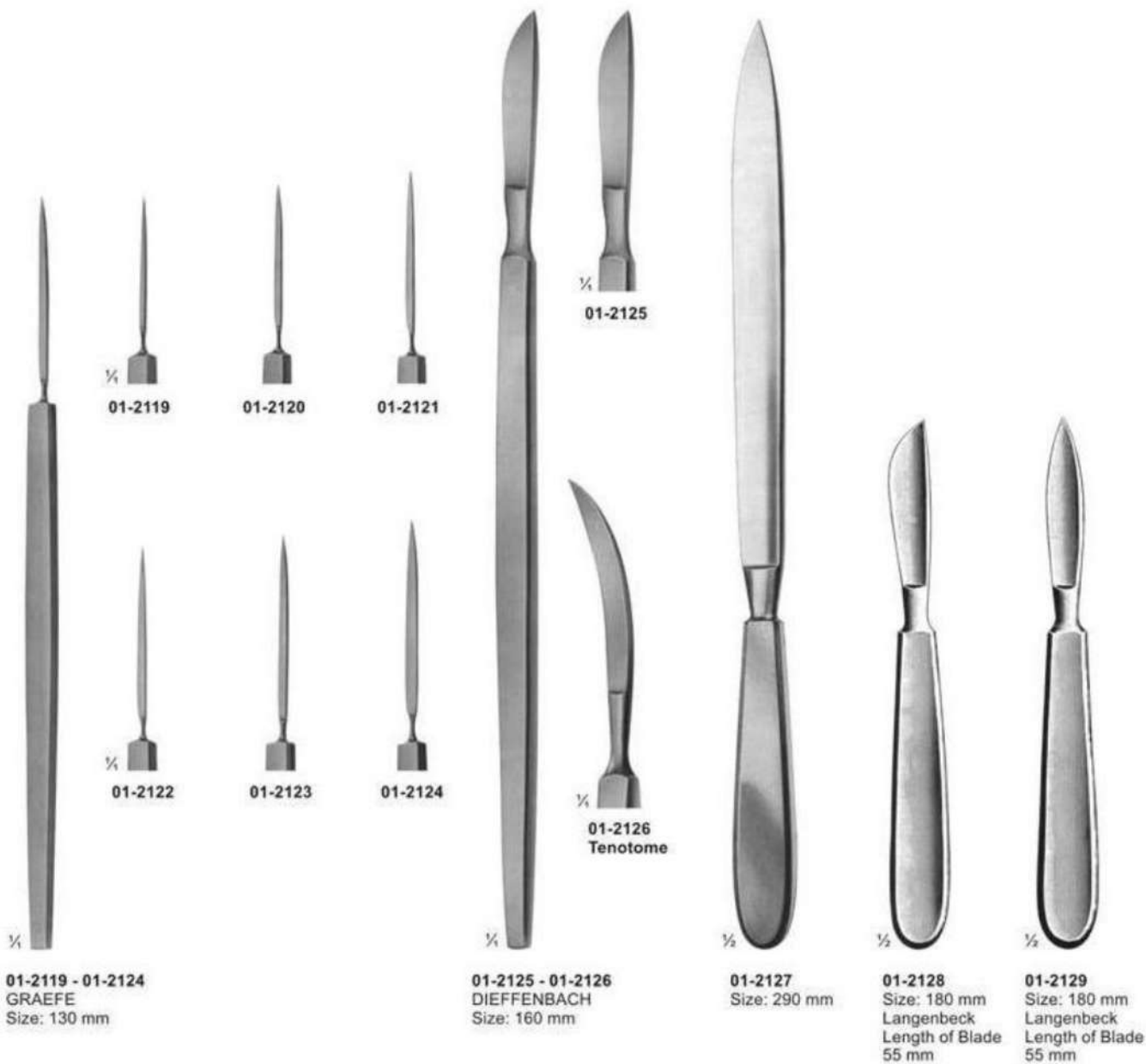

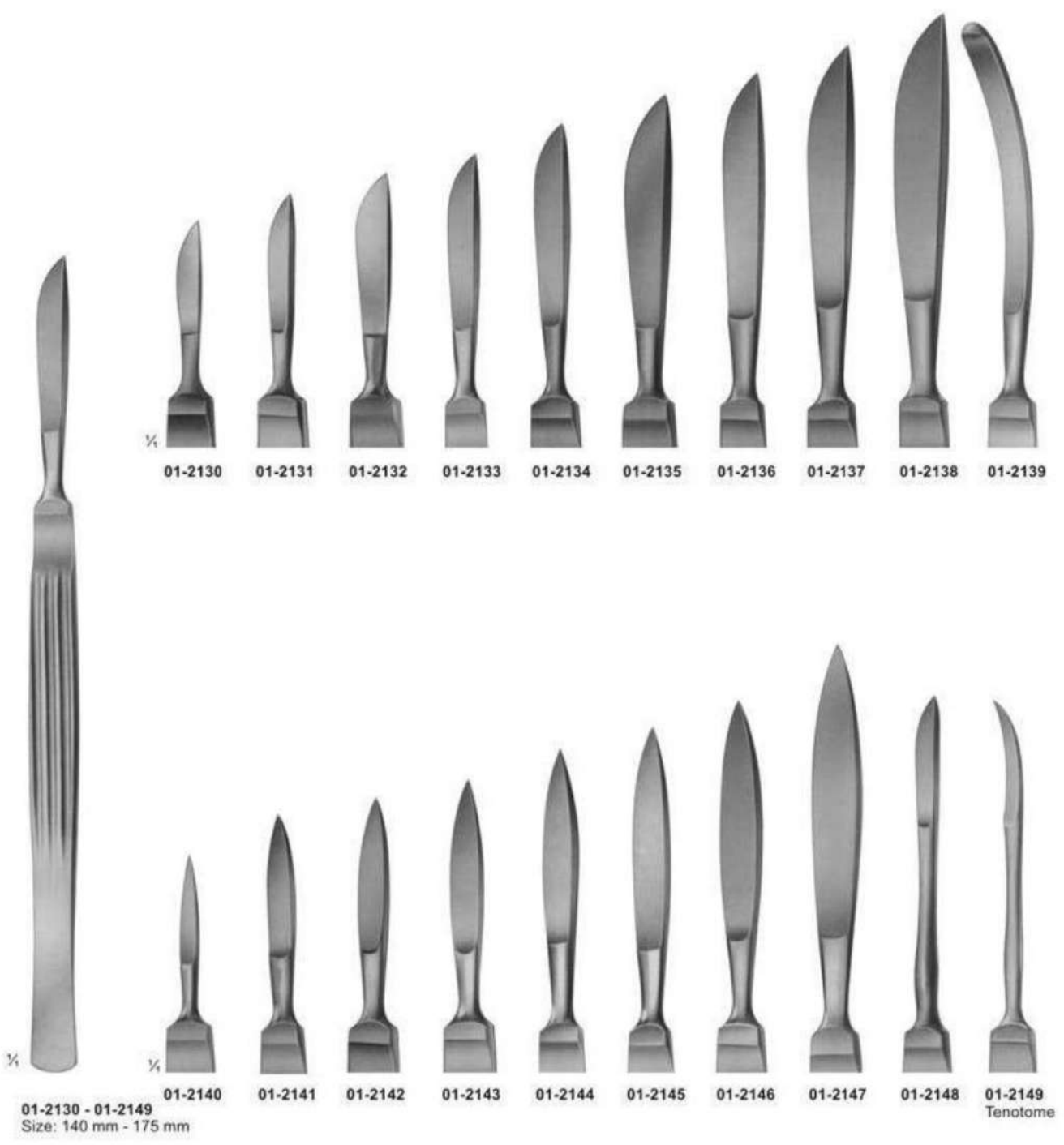

Double Cutting



Double Cutting



LISTON
01-2150
Size: 130 mm
01-2151
Size: 160 mm
01-2152
Size: 190 mm
01-2153
Size: 220 mm

01-2154
CATLIN
Size: 160 mm
Blade Length
Amputating
Knives

01-2155
LANGENBECK
Size: 120 mm
Blade Length
Flap Knives

01-2156
Size: 110 mm
Blade Length
Interosseous
Knives

01-2157
Size: 55 mm
Blade Length
With Raspator,
Wooden Handle

01-2158
Size: 70 mm
Blade Length
Wooden Handle

01-2159
Size: 80 mm
Blade Length
Metal Handle

Blade Length
Amputating Knives



<p>01-2161 AYRE Size: 235 mm Cone Knife</p>	<p>01-2162 Size: 230 mm Cone Knife</p>	<p>01-2163 SEGOND Size: 270 mm Myomatome</p>	<p>01-2164 OLIVECRONA Size: 205 mm Trigeminal Knife</p>	<p>01-2165 Size: 230 mm Trigeminal Knife</p>	<p>01-2166 FOWLER Size: 200 mm Tonsil Knife</p>	<p>01-2167 ABRAHAM Size: 215 mm Tonsil Knife</p>	<p>01-2168 BRUENINGS Size: 215 mm Tonsil Knife</p>
--	---	---	--	---	--	---	---



01-2169
Straight

01-2170
Curved

01-2169 - 01-2170
JOSEPH
Size: 145 mm
Double Edged
Nasal Knives, Pointed

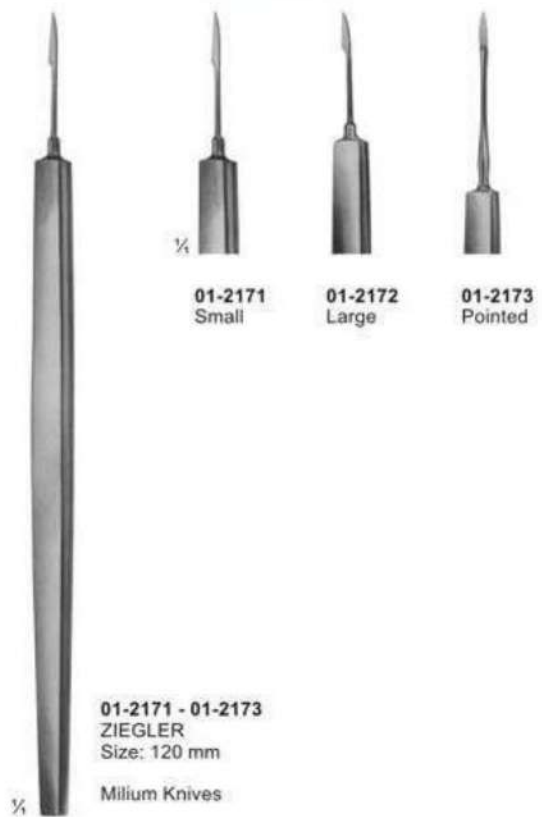

01-2171
Small

01-2172
Large

01-2173
Pointed

01-2171 - 01-2173
ZIEGLER
Size: 120 mm
Milium Knives



01-2174
VIDAL
Lupus Scraper
Size: 135 mm

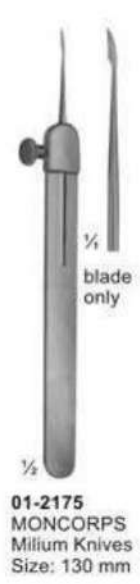

01-2175
MONCORPS
Milium Knives
Size: 130 mm



01-2176
SAALFELD
Size: 100 mm

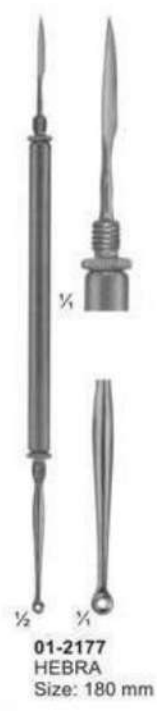

01-2177
HEBRA
Size: 180 mm



01-2178
UNNA
Size: 145 mm



01-2179
UNNA
Size: 145 mm

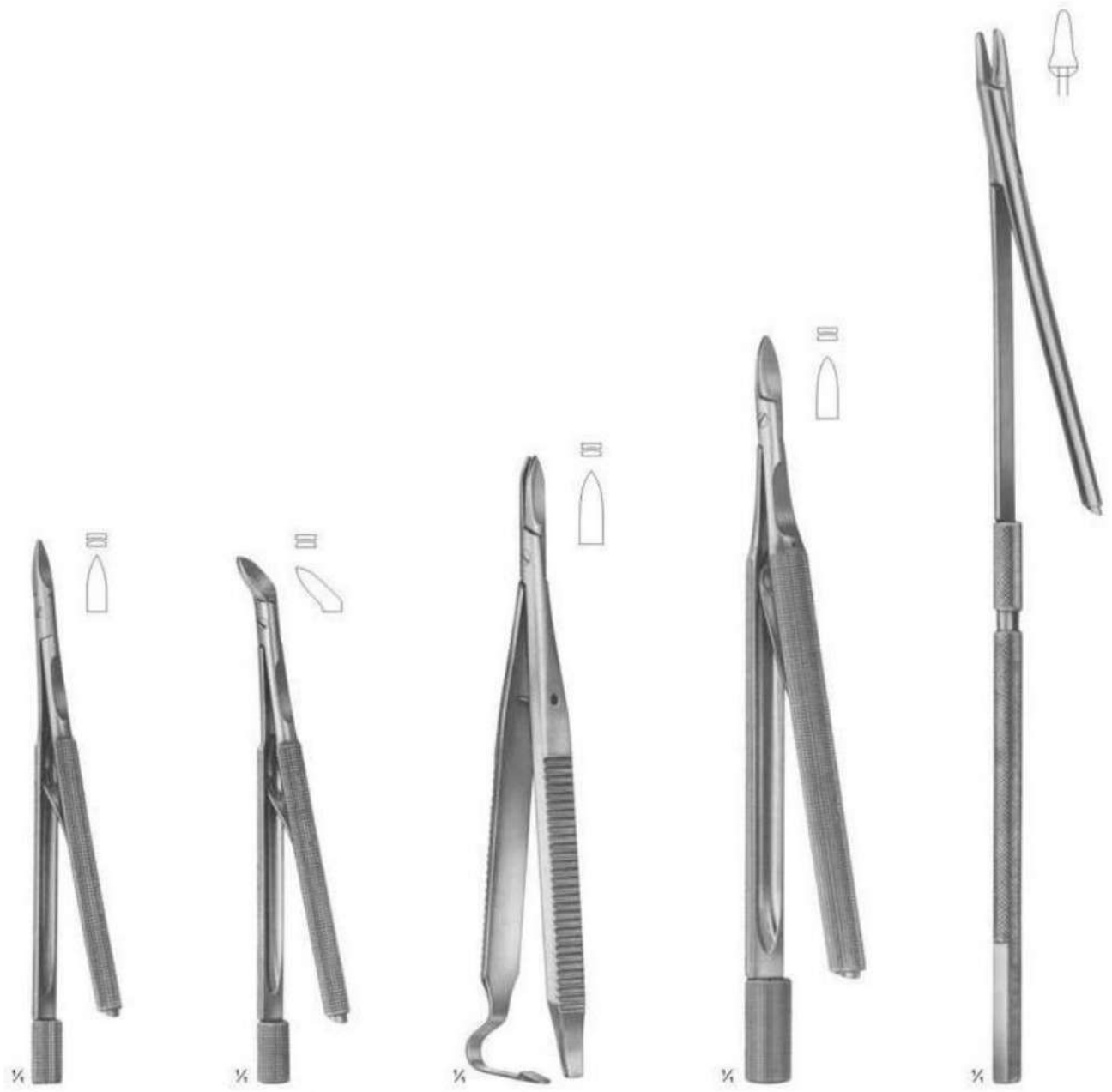

01-2180
TROUTMAN-CHRIS
Size: 90 mm
Handle Diameter 5.5 mm

01-2181
TROUTMAN-CHRIS
Size: 90 mm
Handle Diameter 5.5 mm

01-2182
Size: 110 mm

01-2183
CASTROVIEJO
Size: 130 mm
Handle Diameter 8 mm

01-2184
Size: 185 mm
Razor Blade
Breaker & Holder,
Straight

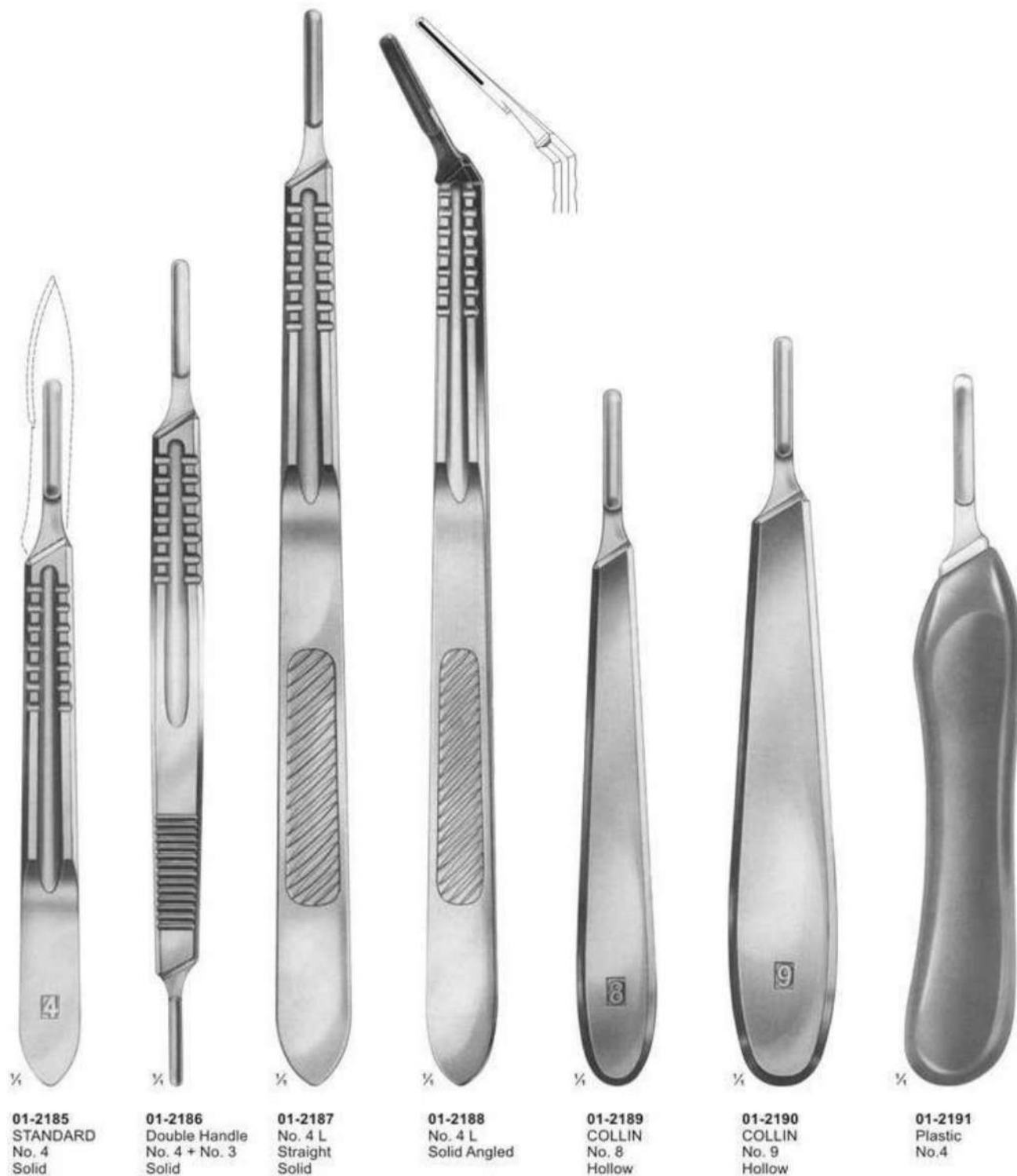

01-2185
STANDARD
No. 4
Solid

01-2186
Double Handle
No. 4 + No. 3
Solid

01-2187
No. 4 L
Straight
Solid

01-2188
No. 4 L
Solid Angled

01-2189
COLLIN
No. 8
Hollow

01-2190
COLLIN
No. 9
Hollow

01-2191
Plastic
No.4



<p>01-2192 STANDARD No. 3 Solid Size:12cm</p>	<p>01-2193 No. 3 Solid Size:12cm solid handle style as No.4</p>	<p>01-2194 No. 3 Solid Size:12cm cm-graduation</p>	<p>01-2195 No. 3 L Straight Solid, long Size:21.5cm</p>	<p>01-2196 No. 3 L Angled Solid, long Size:21cm</p>	<p>01-2197 No. 7 Solid Size:16cm</p>	<p>01-2198 No. 7 K Solid, short Size:12.5cm</p>	<p>01-2199 No.3 Size:15.5cm with round hollow handle</p>	<p>01-2200 No. 3 Straight Solid, Round Size:14.5cm</p>	<p>01-2201 No. 3 Angled Solid, Round Size:14cm</p>
--	--	---	--	--	---	--	---	---	---

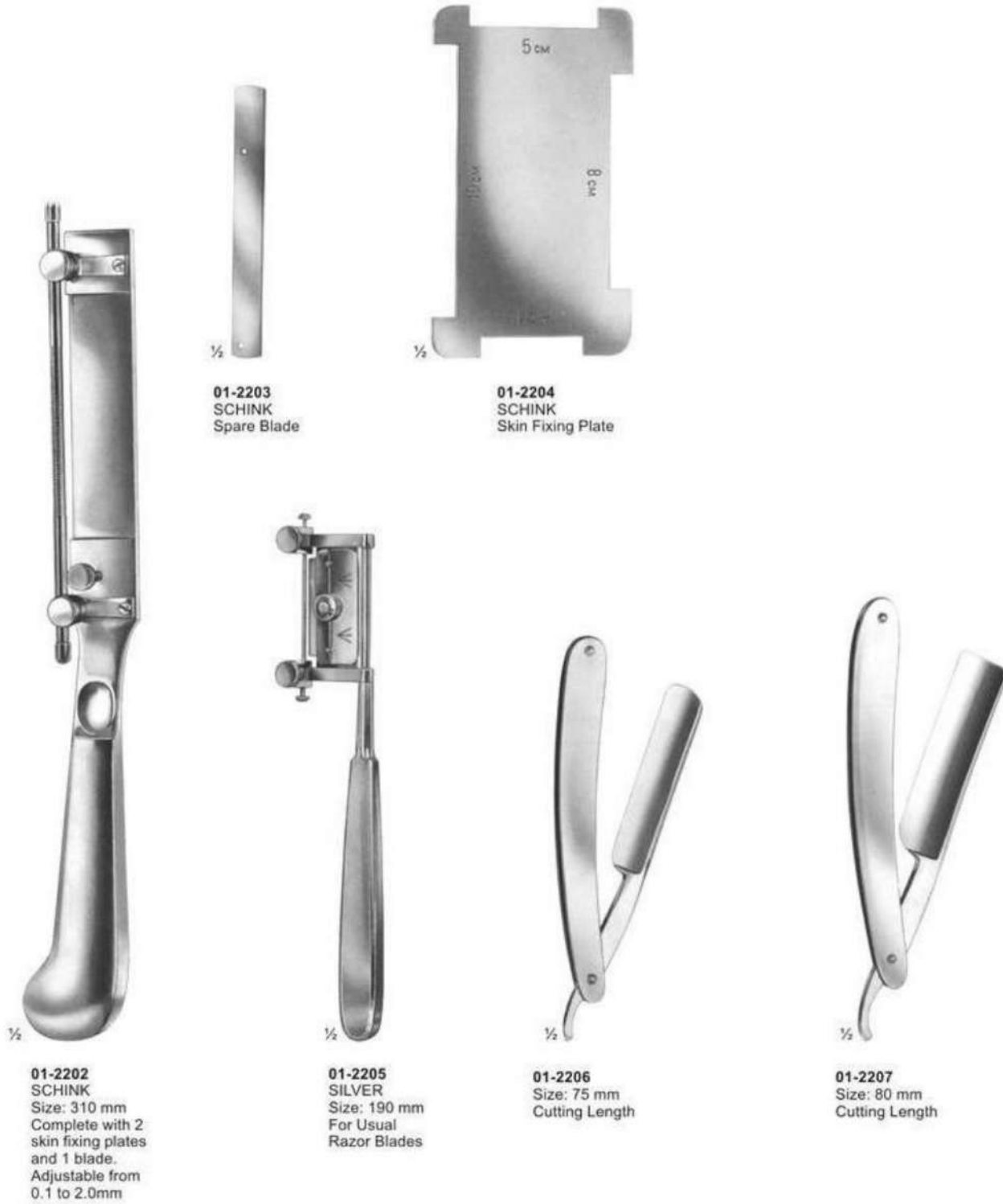

01-2202
SCHINK
Size: 310 mm
Complete with 2
skin fixing plates
and 1 blade.
Adjustable from
0.1 to 2.0mm

01-2203
SCHINK
Spare Blade

01-2204
SCHINK
Skin Fixing Plate

01-2205
SILVER
Size: 190 mm
For Usual
Razor Blades

01-2206
Size: 75 mm
Cutting Length

01-2207
Size: 80 mm
Cutting Length

Section - 02

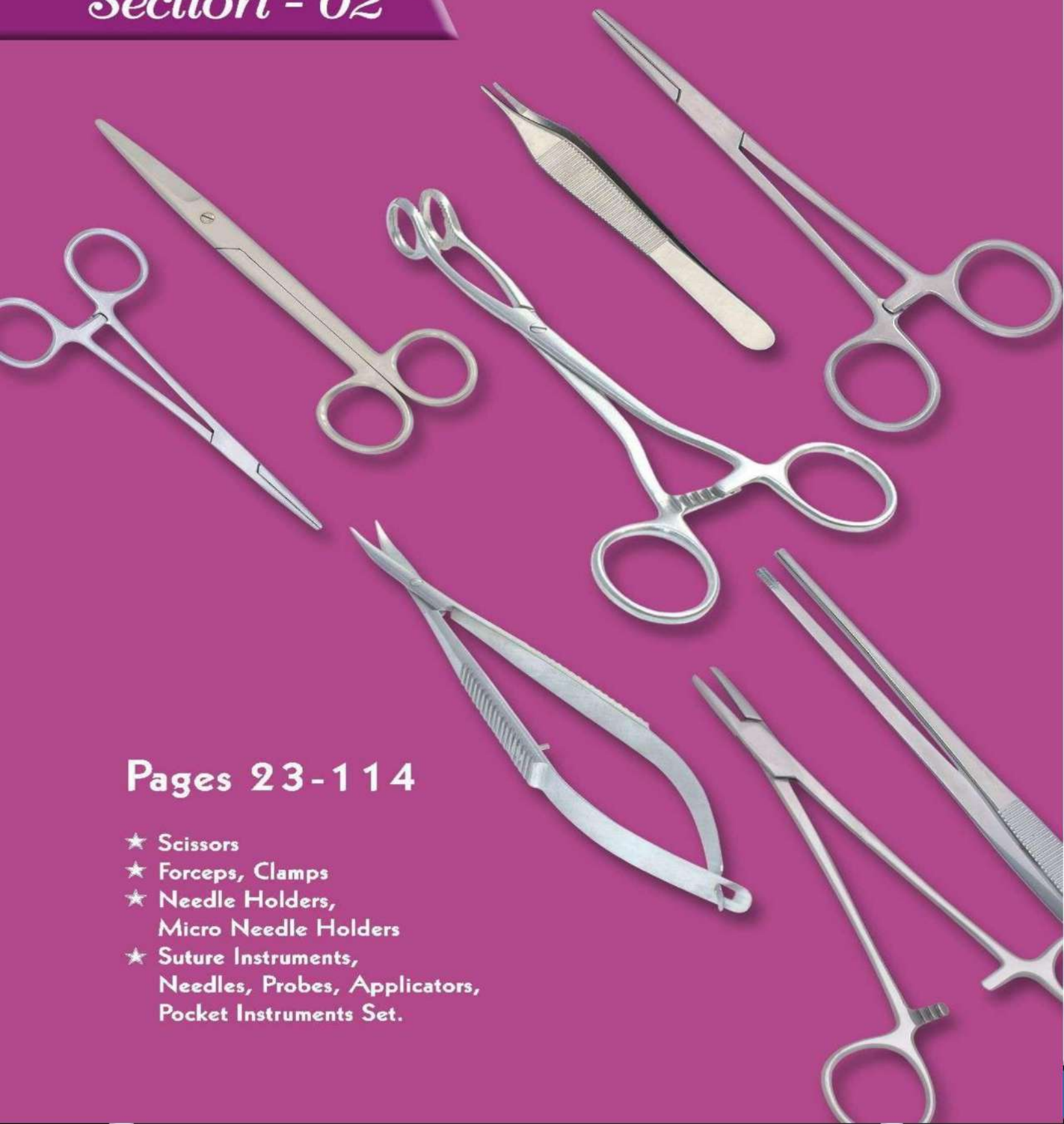

Pages 23-114

- ★ Scissors
- ★ Forceps, Clamps
- ★ Needle Holders,
Micro Needle Holders
- ★ Suture Instruments,
Needles, Probes, Applicators,
Pocket Instruments Set.

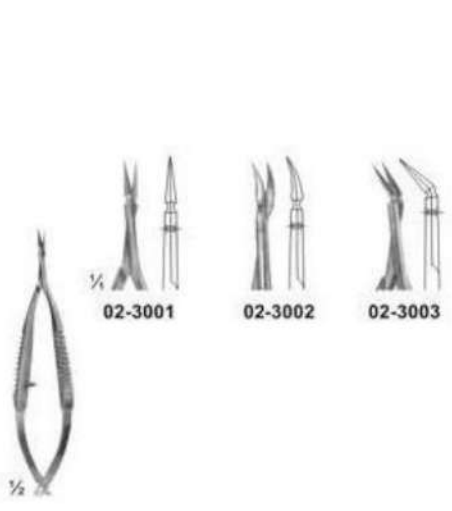

02-3001 - 02-3003
VANNAS
Size: 85 mm

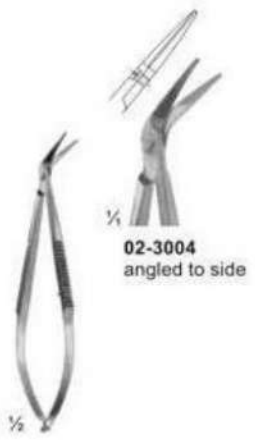

02-3004 - 02-3005
CASTROVIEJO
Size: 95 mm



02-3006
NOYES
Size: 125 mm

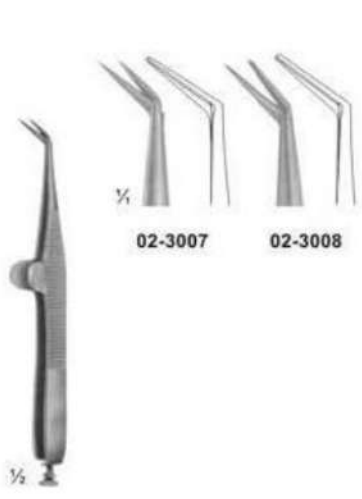

02-3007 - 02-3008
WECKER
Eye Scissor
Size: 110 mm

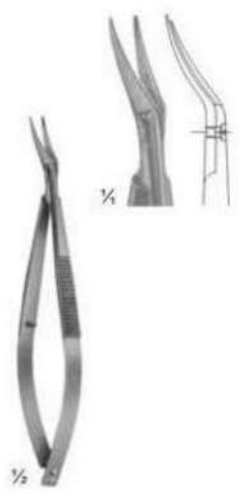

02-3009
CASTROVIEJO
Eye Scissor
Size: 115 mm

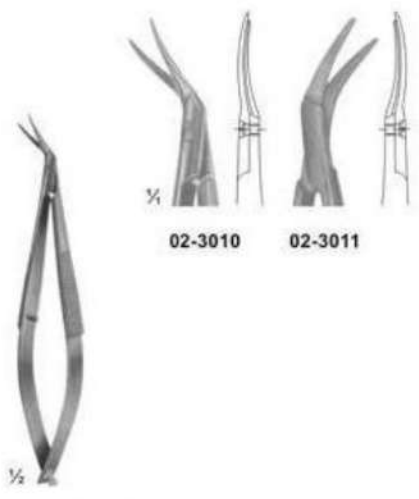

02-3010 - 02-3011
CASTROVIEJO
Eye Scissor
Size: 110 mm



02-3012
BIEMER
Vein Scissor
Size: 130 mm

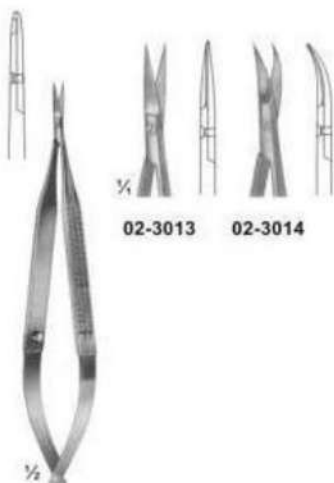

02-3013 - 02-3014
Size: 120 mm



02-3015 - 02-3016
Size: 160 mm

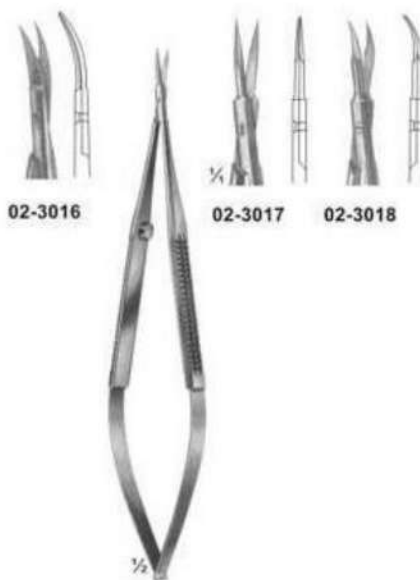

023017 - 02-3018
VANNAS
Size: 160 mm



02-3019
CASPAR
Micro Scissor Curved

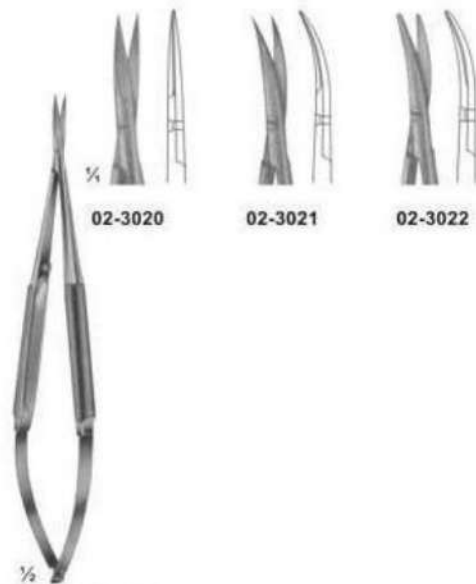

02-3020 - 02-3022
Micro Dissecting Scissor
Size: 145 mm



02-3023
YASARGIL
Size: 245 mm



02-3024
45°
Nagel



02-3025
45°



02-3024 - 02-3025
Laterally Angled
Size: 200 mm



125°



02-3026
Laterally Angled
Size: 190 mm



02-3027



02-3028



02-3027 - 02-3028
YASARGIL
Size: 225 mm

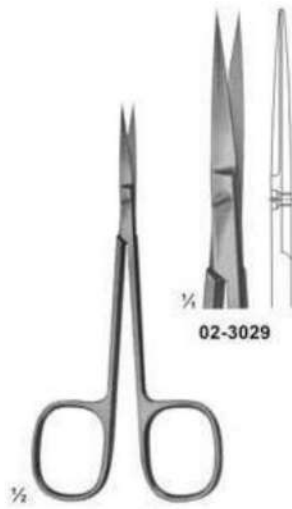

02-3029



02-3030

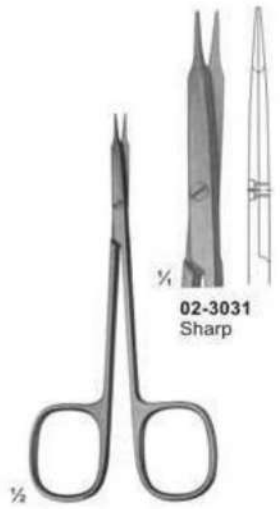

02-3031 Sharp



02-3032 Sharp

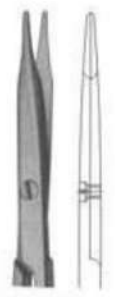

02-3033 Blunt

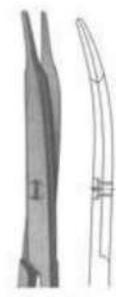

02-3034 Blunt

02-3029-02-3030
Size: 120 mm

02-3031 - 02-3034
STEVENS
Dissecting Scissors
Size: 115 mm

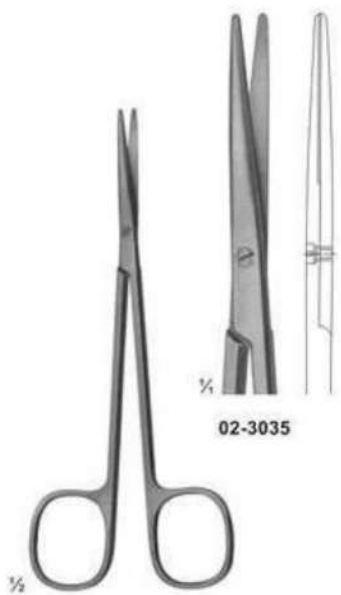

02-3035



02-3036

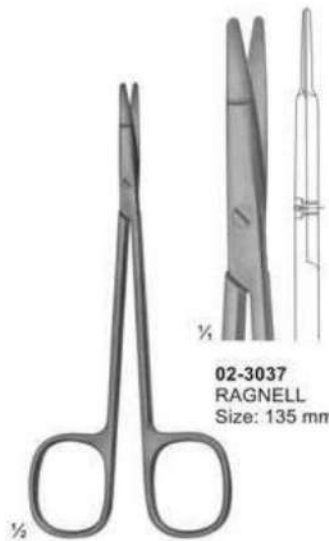

02-3037
RAGNELL
Size: 135 mm



02-3038
RAGNELL
Size: 135 mm

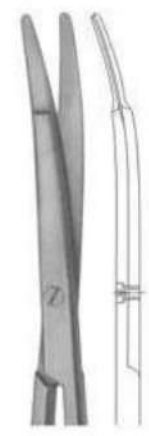

02-3039
Size: 150 mm

02-3035 - 02-3036
METZENBAUM
Dissecting Scissors
Size: 145 mm

02-3037 - 02-3039
Special flat points for
dissecting and
undermining the skin



02-3040



02-3041



02-3042



02-3043

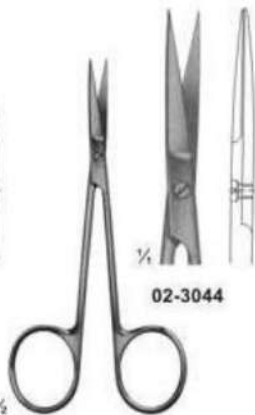

02-3044

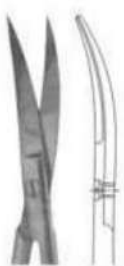

02-3045

02-3040 - 02-3041
Size: 90 mm

02-3042 - 02-3043
Size: 95 mm

02-3044 - 02-3045
Size: 105 mm

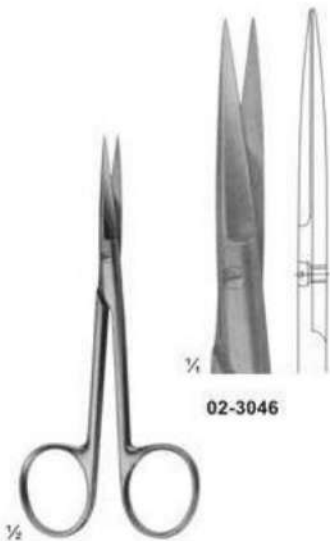

02-3046



02-3047

02-3046 - 02-3047
Size: 120 mm



02-3048

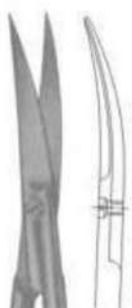

02-3049

02-3048 - 02-3049
Size: 115 mm



02-3050 - 02-3052
Size: 120 mm

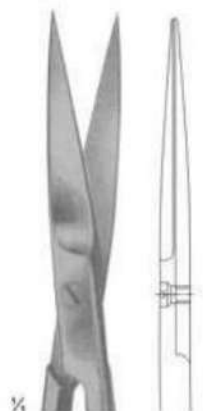

02-3050

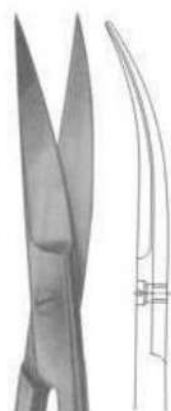

02-3051

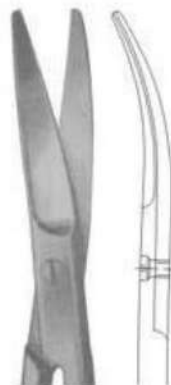

02-3052



02-3053 - 02-3056
Size: 130 mm

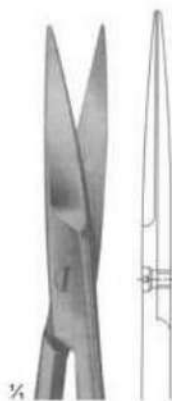

02-3053

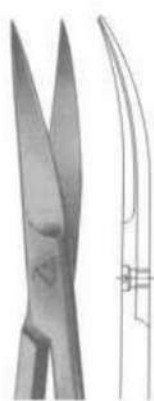

02-3054

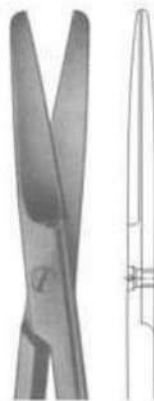

02-3055



02-3056

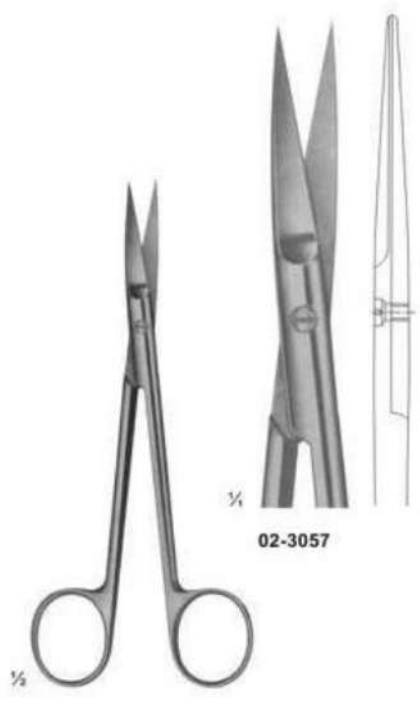

02-3057

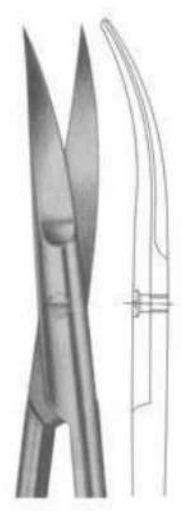

02-3058

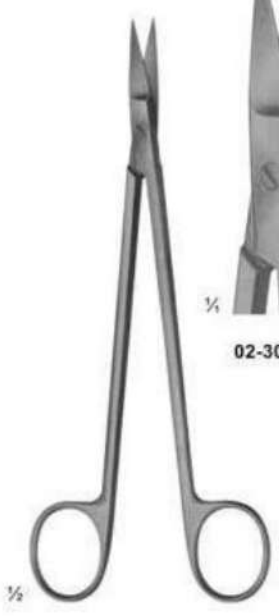

02-3059

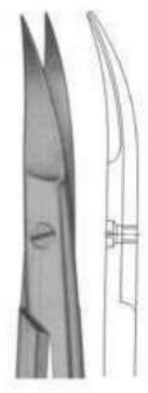

02-3060

02-3057 - 02-3058
JOSEPH
Size: 150 mm

02-3059 - 02-3060
KELLY
Size: 175 mm



02-3061
QUINBY
Size: 130 mm

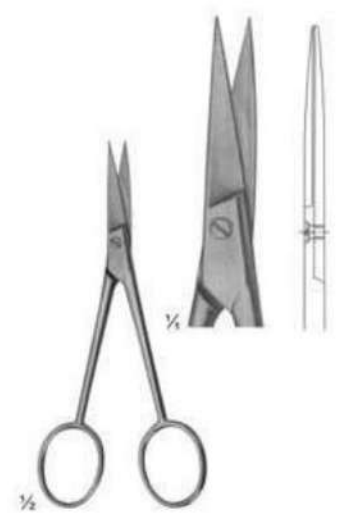

02-3062
Size: 110 mm



02-3063 - 02-3071 (Standard Types)
02-3063 (105 mm)
02-3064 (115 mm)
02-3065 (130 mm)
02-3066 (145 mm)
02-3067 (150 mm)
02-3068 (165 mm)
02-3069 (175 mm)
02-3070 (185 mm)
02-3071 (200 mm)

02-3063
Size: 105 mm

02-3071
Size: 200 mm

02-3072 - 02-3078 (Standard Types)
02-3072 (115 mm)
02-3073 (130 mm)
02-3074 (145 mm)
02-3075 (150 mm)
02-3076 (165 mm)
02-3077 (175 mm)
02-3078 (185 mm)

02-3072
Size: 115 mm

02-3078
Size: 185 mm



02-3079 - 02-3082
Slender Types

02-3079 130 mm

02-3080 145 mm

02-3081 130 mm

02-3082 145 mm

02-3083 - 02-3084
For Wound Edges
1 Blade Serrated

02-3083
130 mm

02-3084
130 mm



02-3085 - 02-3089 (Standard Types)
 02-3085 (130 mm)
 02-3086 (145 mm)
 02-3087 (150 mm)
 02-3088 (165 mm)
 02-3089 (175 mm)

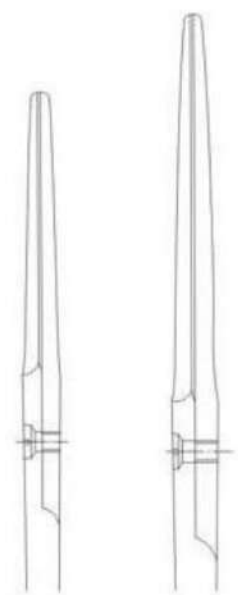

02-3085 Size: 130 mm
02-3089 Size: 175 mm



02-3090 - 02-3095 - COOPER
 Standard Types
 02-3090 (115 mm)
 02-3091 (130 mm)
 02-3092 (145 mm)
 02-3093 (150 mm)
 02-3094 (165 mm)
 02-3095 (175 mm)

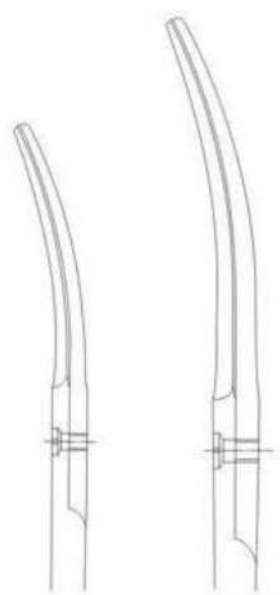

02-3090 Size: 115 mm
02-3095 Size: 175 mm



02-3096 - 02-3102A
 Standard Types
 02-3096 (115 mm)
 02-3097 (130 mm)
 02-3098 (145 mm)
 02-3099 (150 mm)
 02-3100 (165 mm)
 02-3100A (115 mm)
 02-3101 (130 mm)
 02-3101A (145 mm)
 02-3102 (150 mm)
 02-3102A (165 mm)

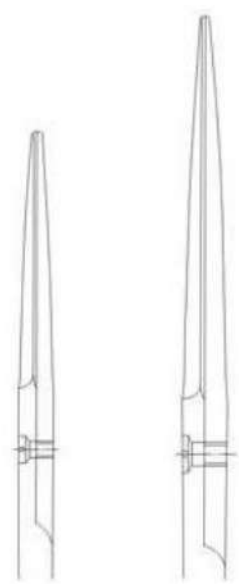

02-3096 Size: 115 mm
02-3100 Size: 165 mm

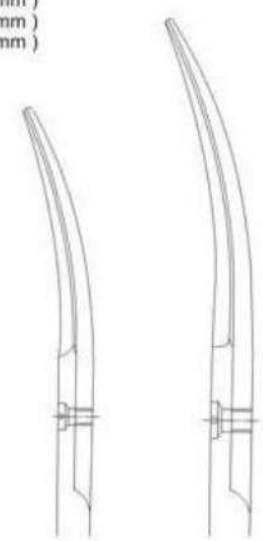

02-3100A Size: 115 mm
02-3102A Size: 165 mm

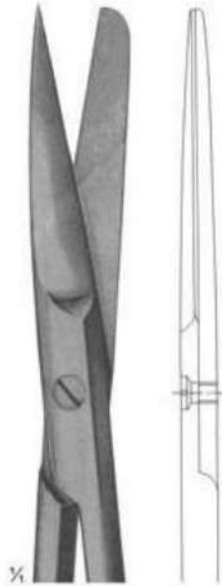

02-3103
Size: 145 mm

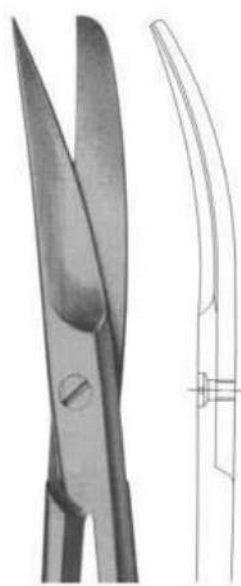

02-3104
Size: 145 mm

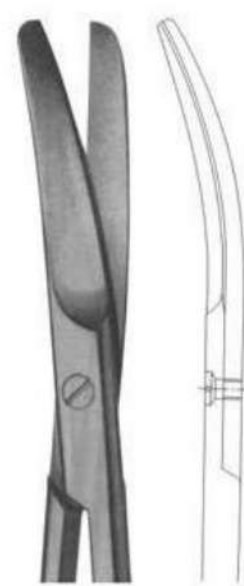

02-3105
Size: 145 mm



02-3106
Size: 145 mm

02-3103 - 02-3106
DEAVER
With flat lock

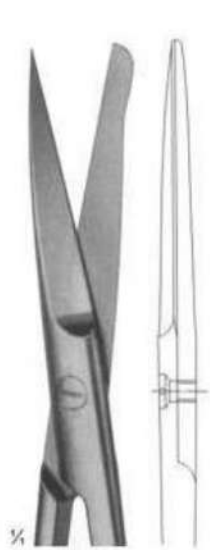

02-3107
Size: 130 mm

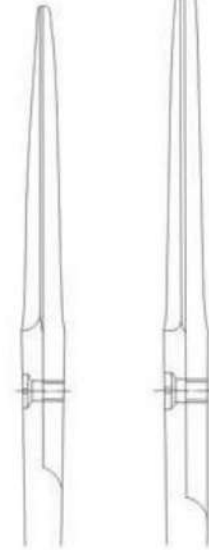

02-3108
Size: 145 mm

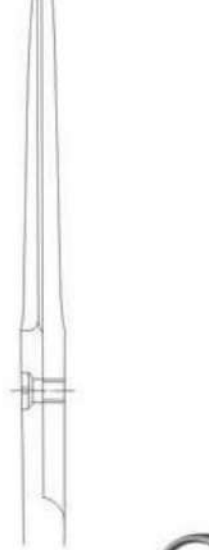

02-3109
Size: 165 mm

02-3107 - 02-3109
Incision Scissors



02-3110
Size: 130 mm

02-3110
SYSTRUNK
Nail Splitting Scissors

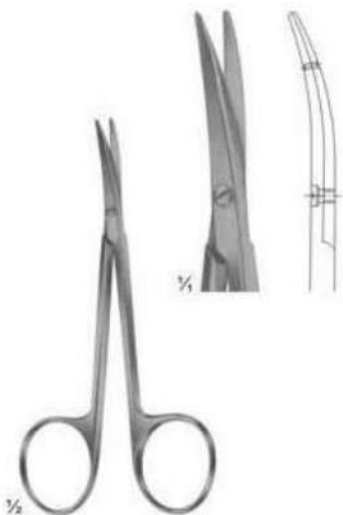

02-3111
LITTLER
Dissecting Scissors
Tips with eye for suture
Size: 115 mm

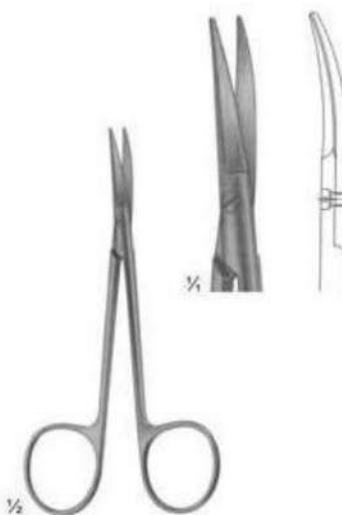

02-3112
COTTLE
Bulldog Scissors
Size: 115 mm



02-3113 - 02-3114
STEVENS
Vessel and tendon Scissors
Size: 100 mm

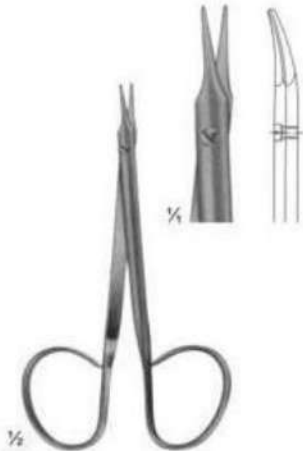

02-3115
STEVENS
Fine Dissecting Scissors
Size: 110 mm

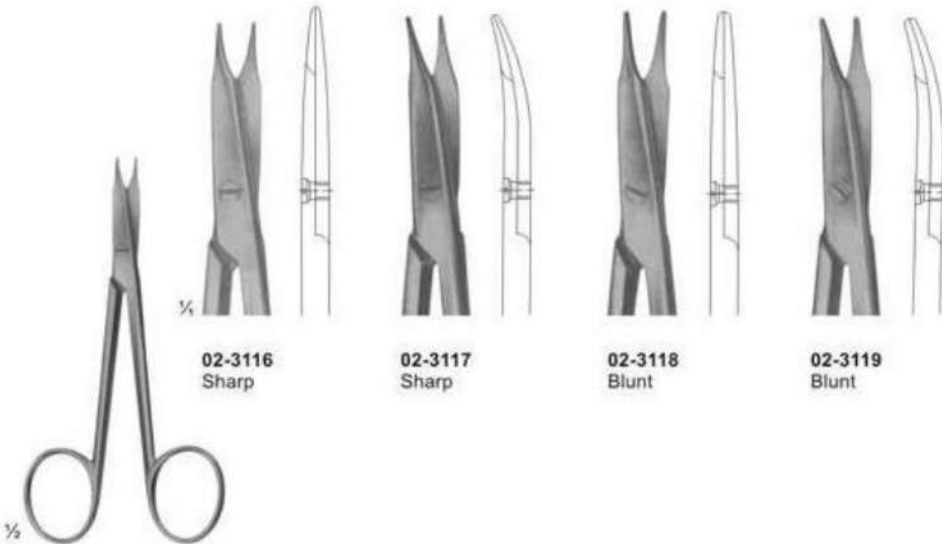

02-3116 - 02-3119
STEVENS
Vessel and tendon Scissors
Size: 110 mm

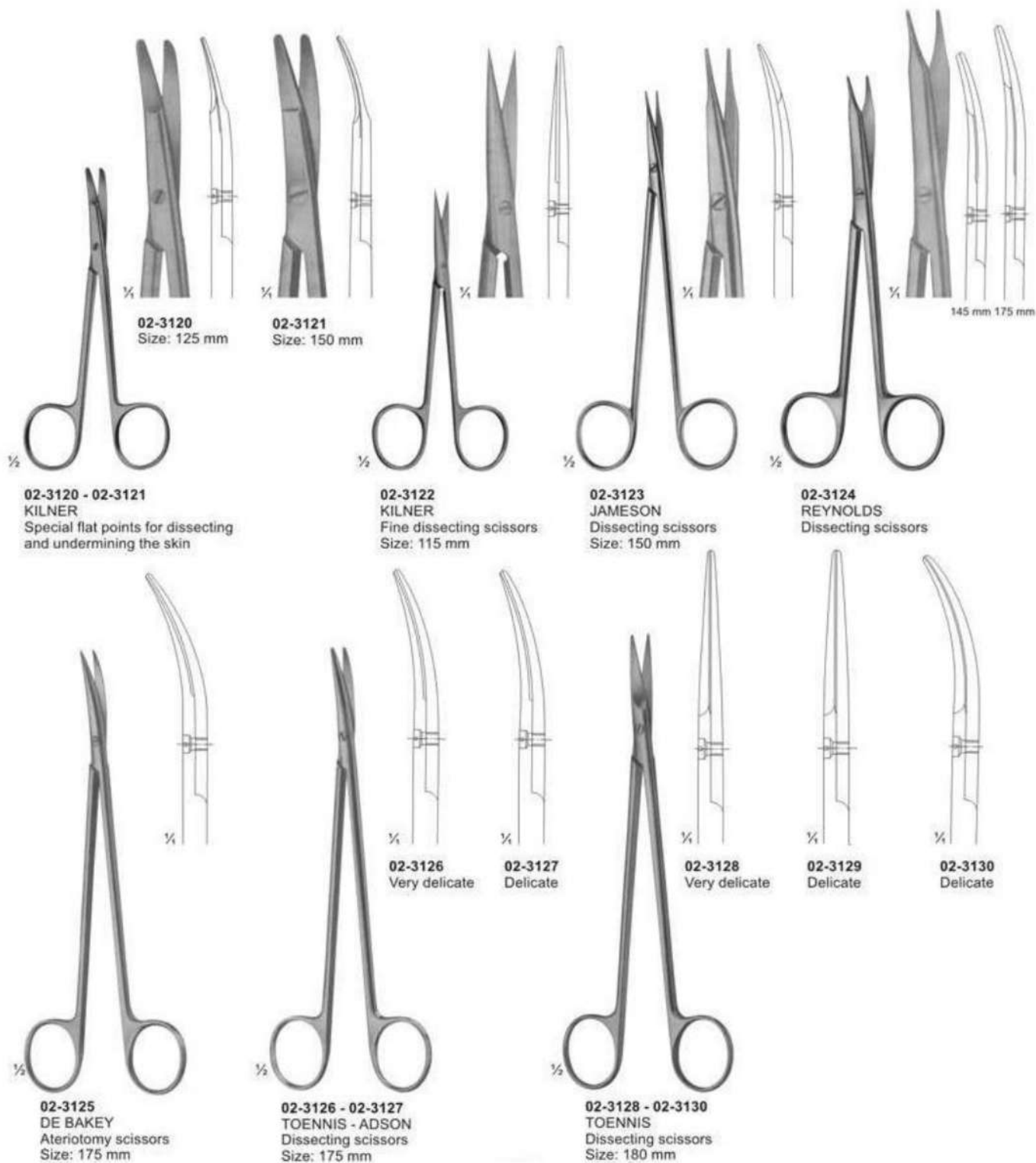

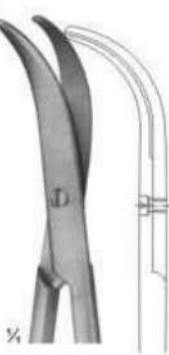

02-3131
Size: 115 mm

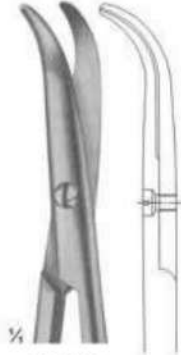

02-3132
Size: 135 mm

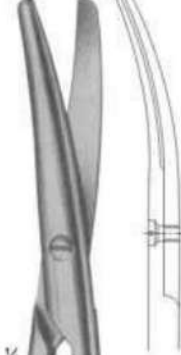

02-3133

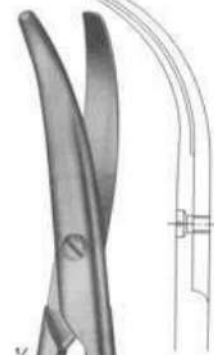

02-3134

02-3133 - 02-3134
LANDOLT
Enucleation scissors
Size: 120 mm

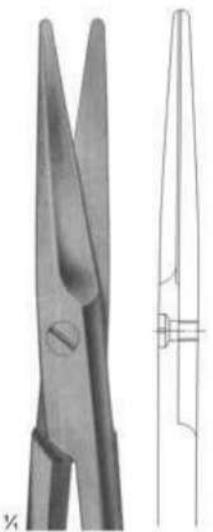

02-3135 - 02-3137

02-3135 - 02-3137
MAYO(straight)
02-3135 (140 mm)
02-3136(155 mm)
02-3137 (170 mm)



02-3138 - 02-3140
MAYO(curved)
02-3138 (140 mm)
02-3139 (155 mm)
02-3140 (170 mm)

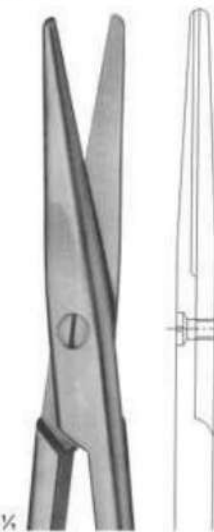

02-3141 - 02-3142

02-3141 - 02-3142
MAYO-STILLE(straight)
02-3141 (140 mm)
02-3142 (170 mm)



02-3143 - 02-3144
MAYO-STILLE(curved)
02-3143 (140 mm)
02-3144 (170 mm)



02-3145 - 02-3146

02-3145 - 02-3146
MAYO-STILLE
With chamfered blades
02-3145 (140 mm)
02-3146 (170 mm)

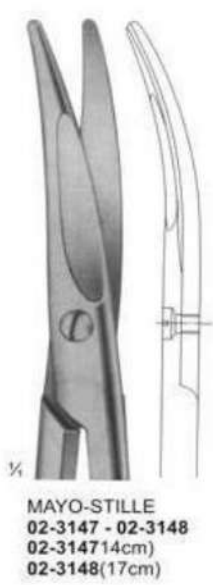

MAYO-STILLE
02-3147 - 02-3148
02-3147 (14cm)
02-3148 (17cm)

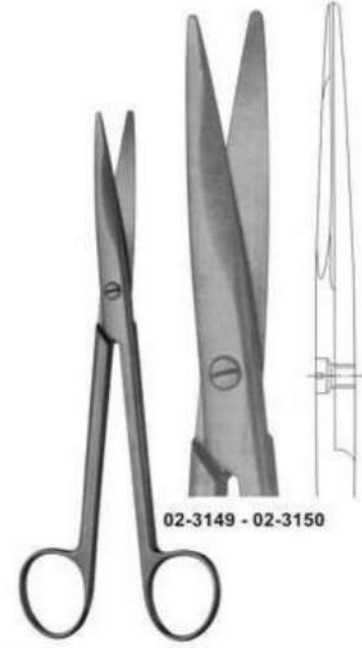

02-3149 - 02-3150

MAYO
With chamfered blades
02-3149 (190 mm)
02-3150 (215 mm)



MAYO
02-3151
Size: 190 mm
02-3152
Size: 215 mm



02-3153
Size: 170 mm

02-3153 - 02-3154
MAYO-NOBLE (Broad pattern)

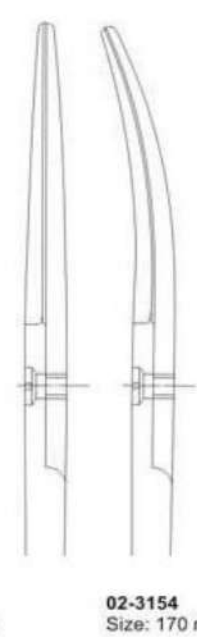

02-3154
Size: 170 mm



02-3155 - 02-3156
MAYO-HARRINGTON



02-3155
Size: 230 mm

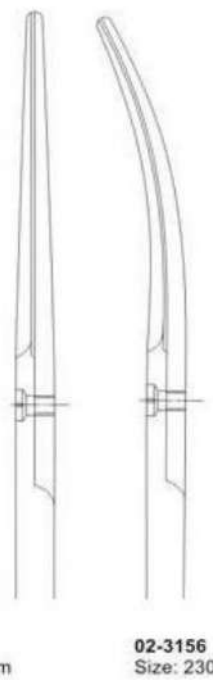

02-3156
Size: 230 mm

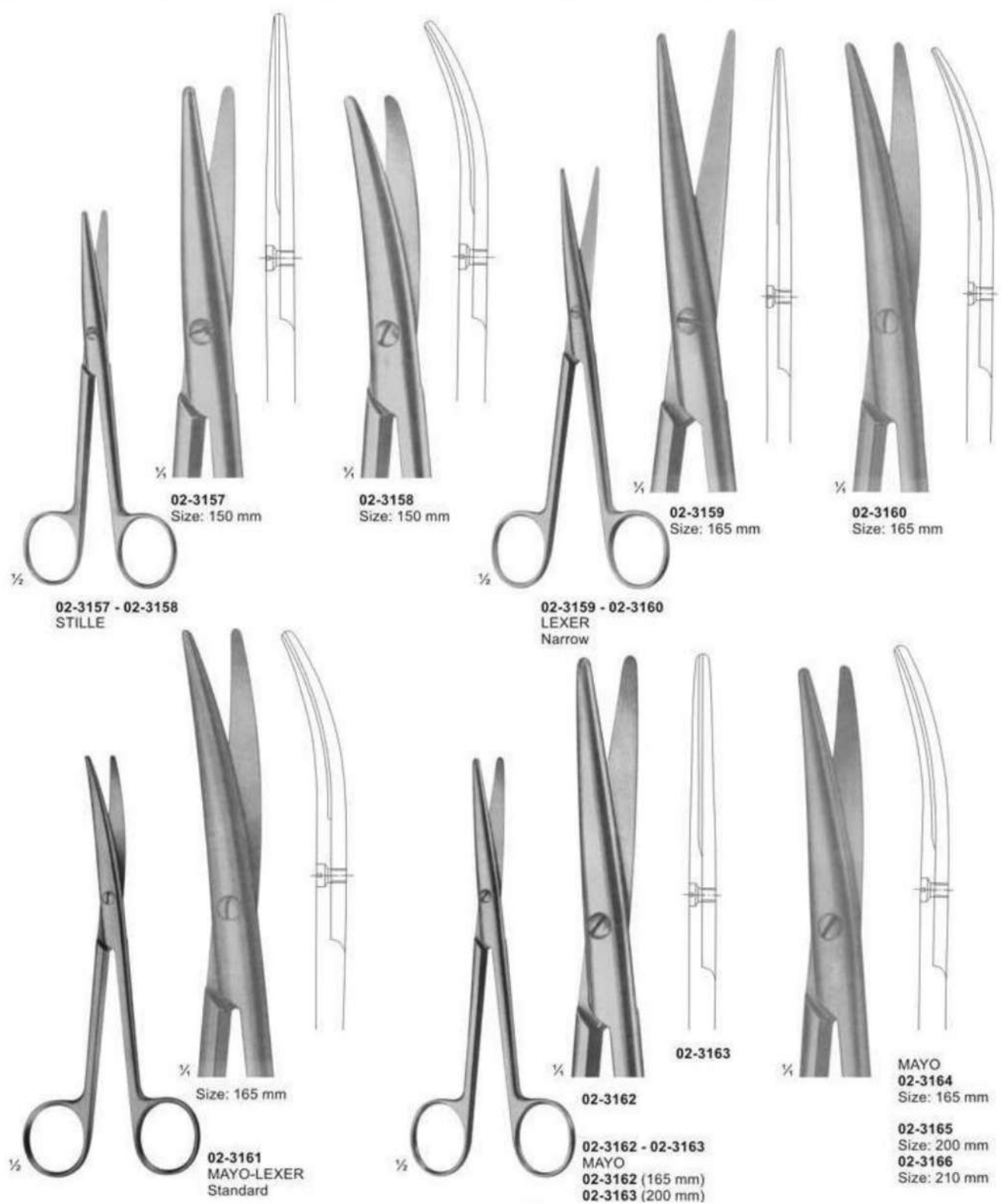

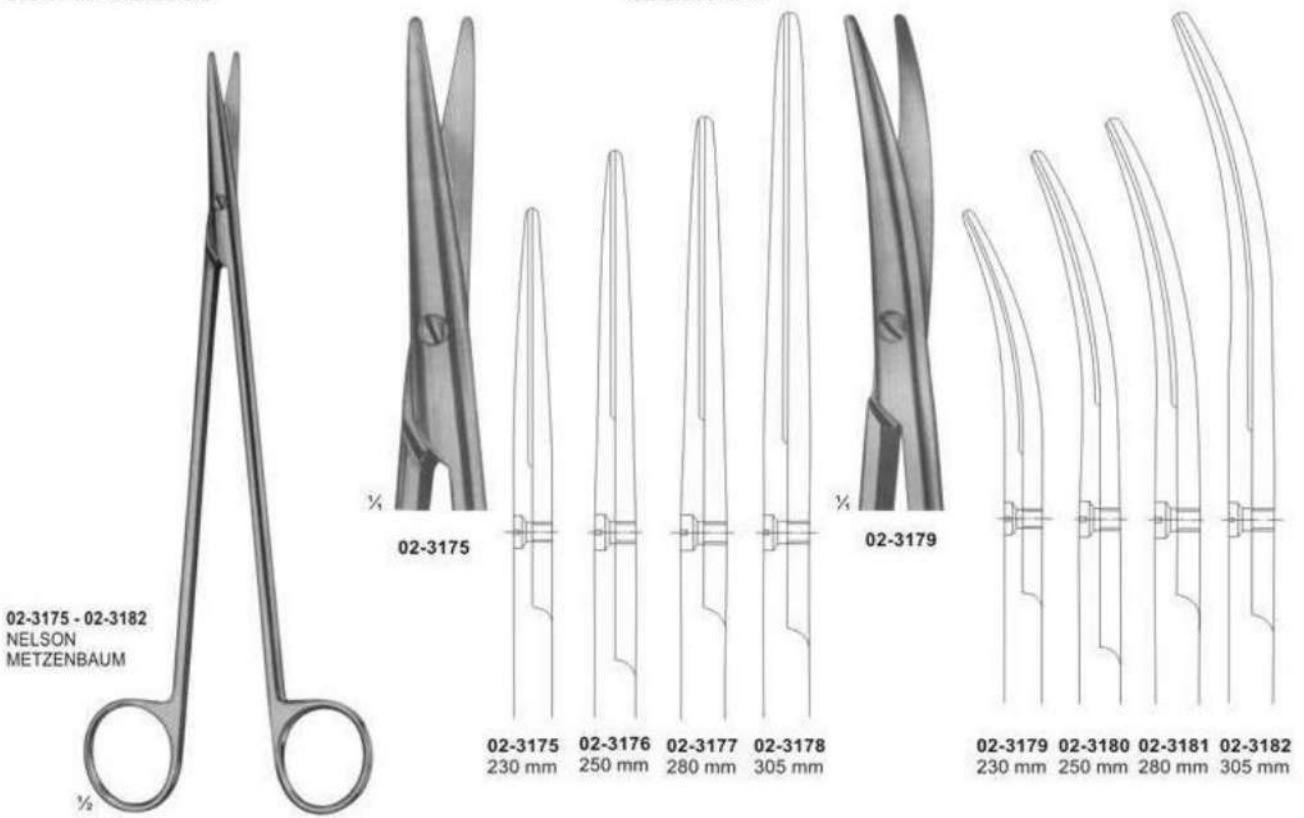
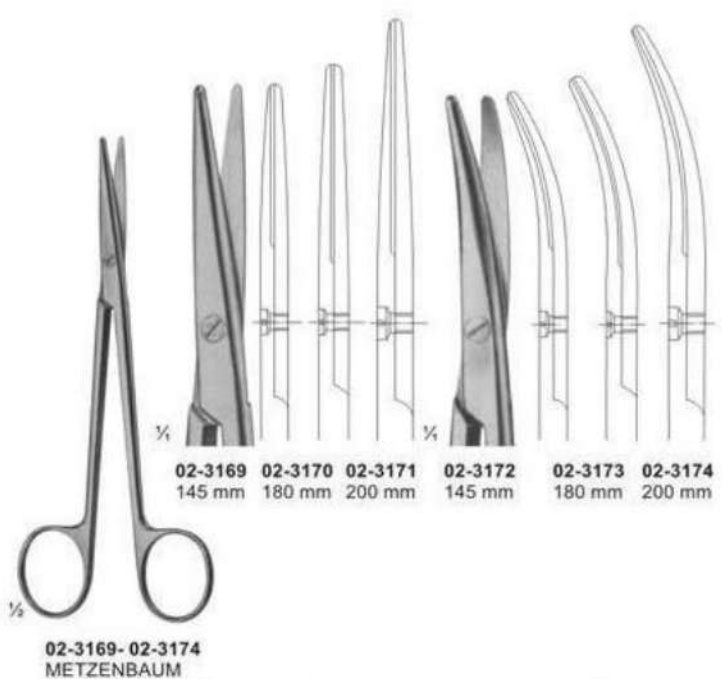
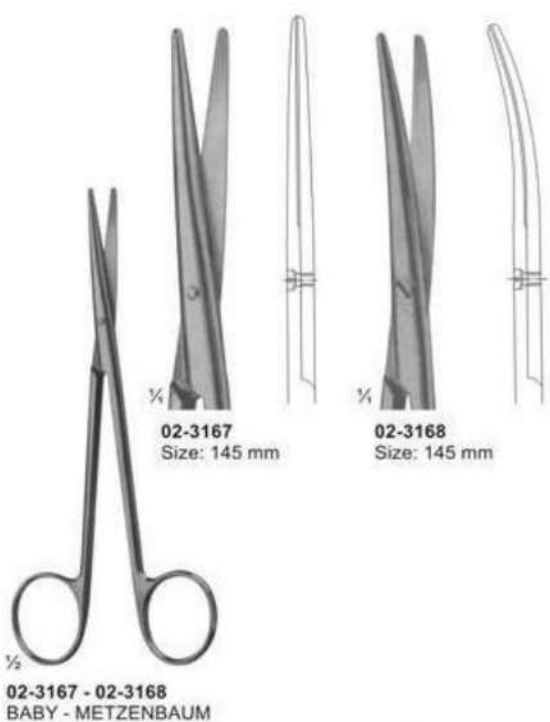

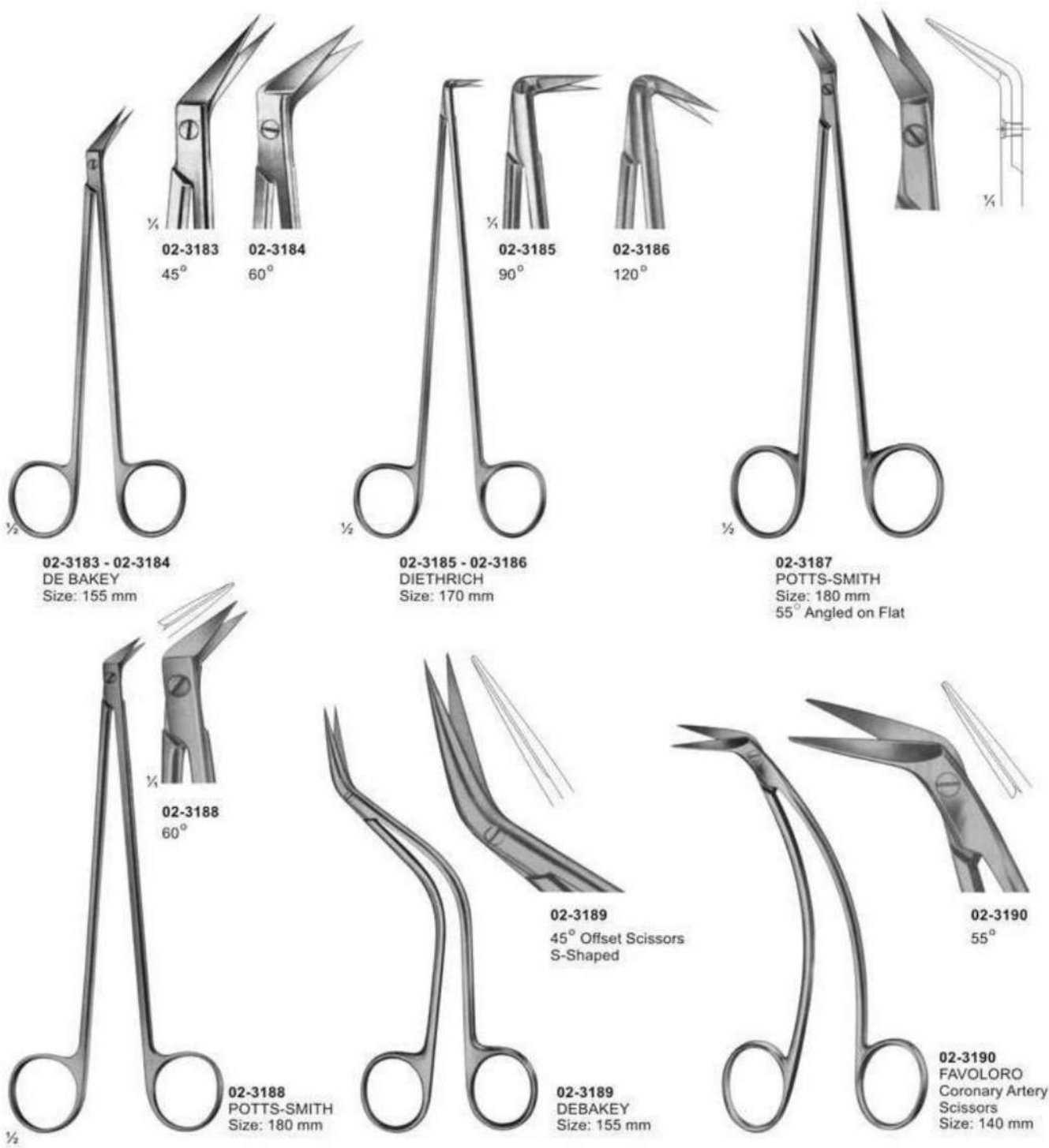



02-3191
OLIVECRONA
Dura Scissors



02-3192
STRULLY
Pointed
Size: 220 mm

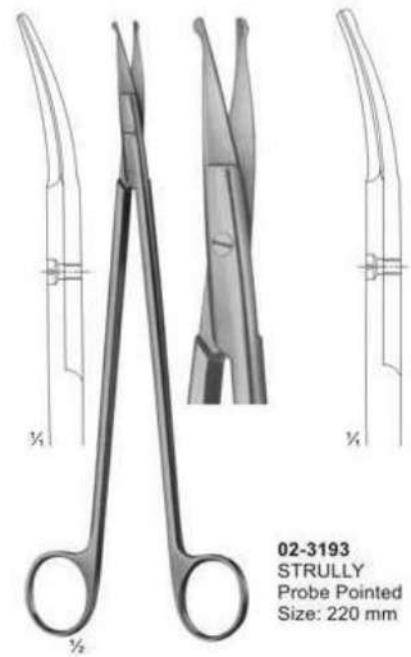

02-3193
STRULLY
Probe Pointed
Size: 220 mm

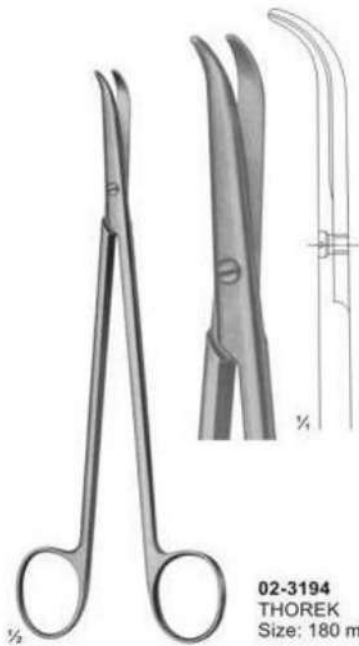

02-3194
THOREK
Size: 180 mm

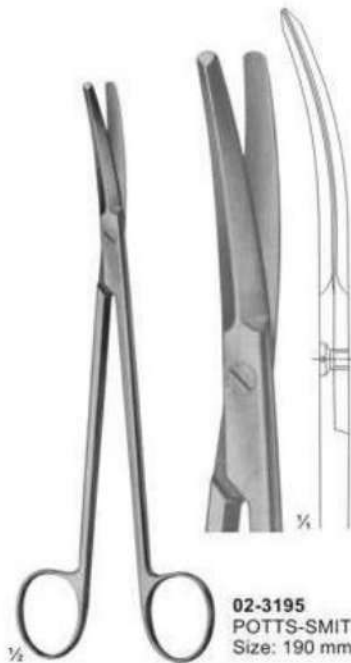

02-3195
POTTS-SMITH
Size: 190 mm

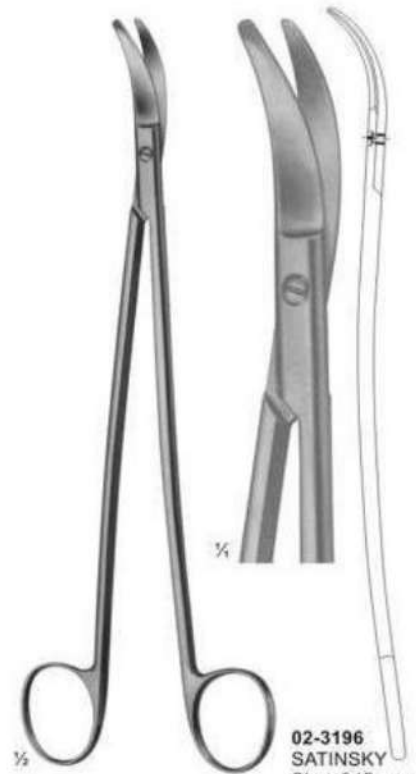

02-3196
SATINSKY
Size: 245 mm



02-3197
1 Finely Toothed Blade
Size: 130 mm

02-3198
LOCKLIN
Curved Sideways,
1 Toothed Blade
Size: 155 mm

02-3199
FOMON
Blades Serrated
Size: 145 mm

02-3200
COTTLE
Size: 165 mm



02-3201
HEYMANN-KNIGHT
Size: 175 mm

02-3202
DEAN
Blades Serrated
Size: 170 mm

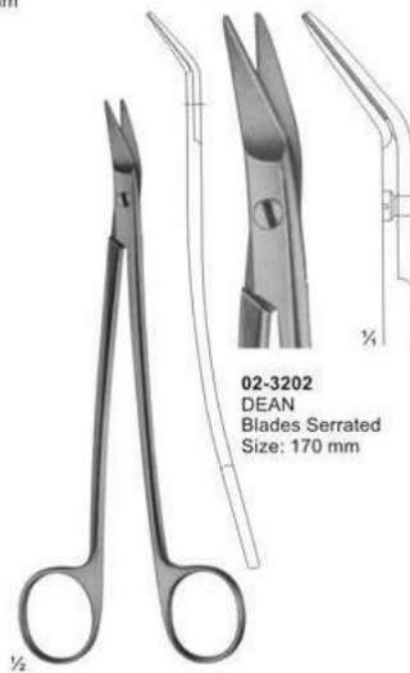

02-3203
GOOD
Size: 195 mm



02-3204
KILLIAN
Size: 200 mm



02-3205 - 02-3206



02-3205
195 mm



$\frac{1}{8}$



02-3206
225 mm



$\frac{1}{8}$

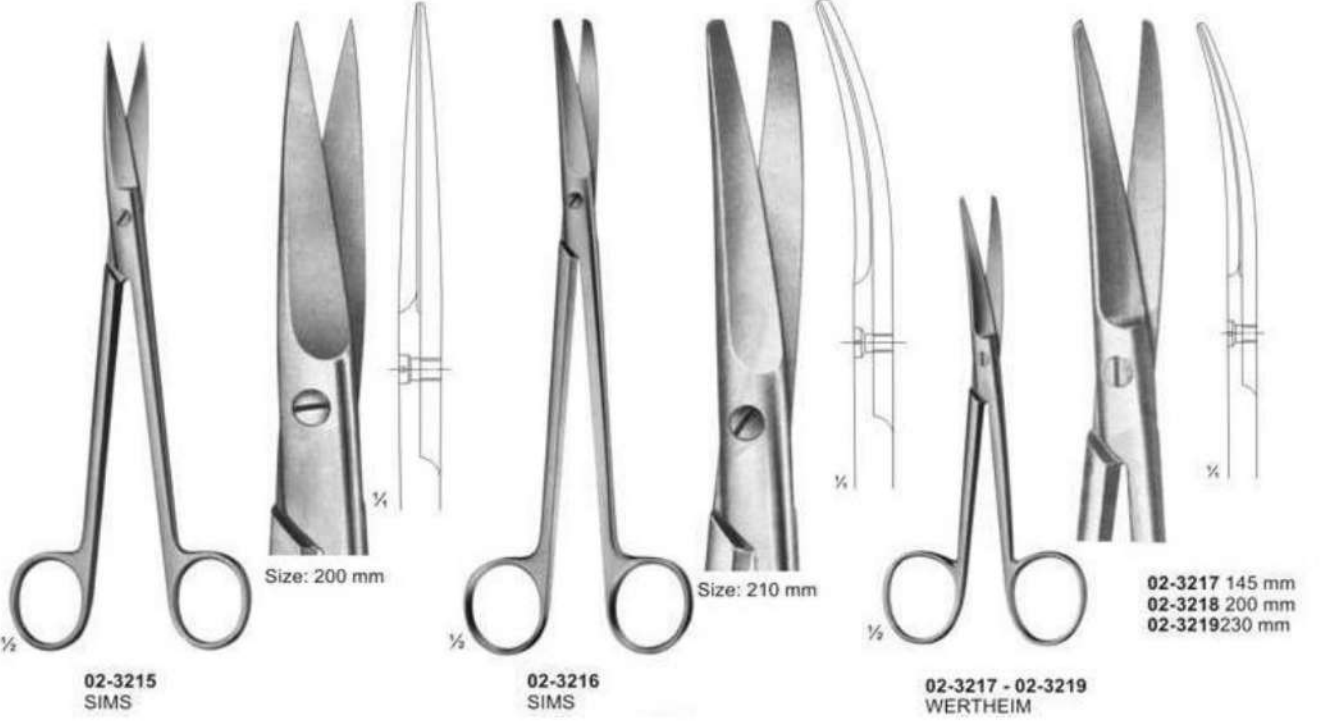
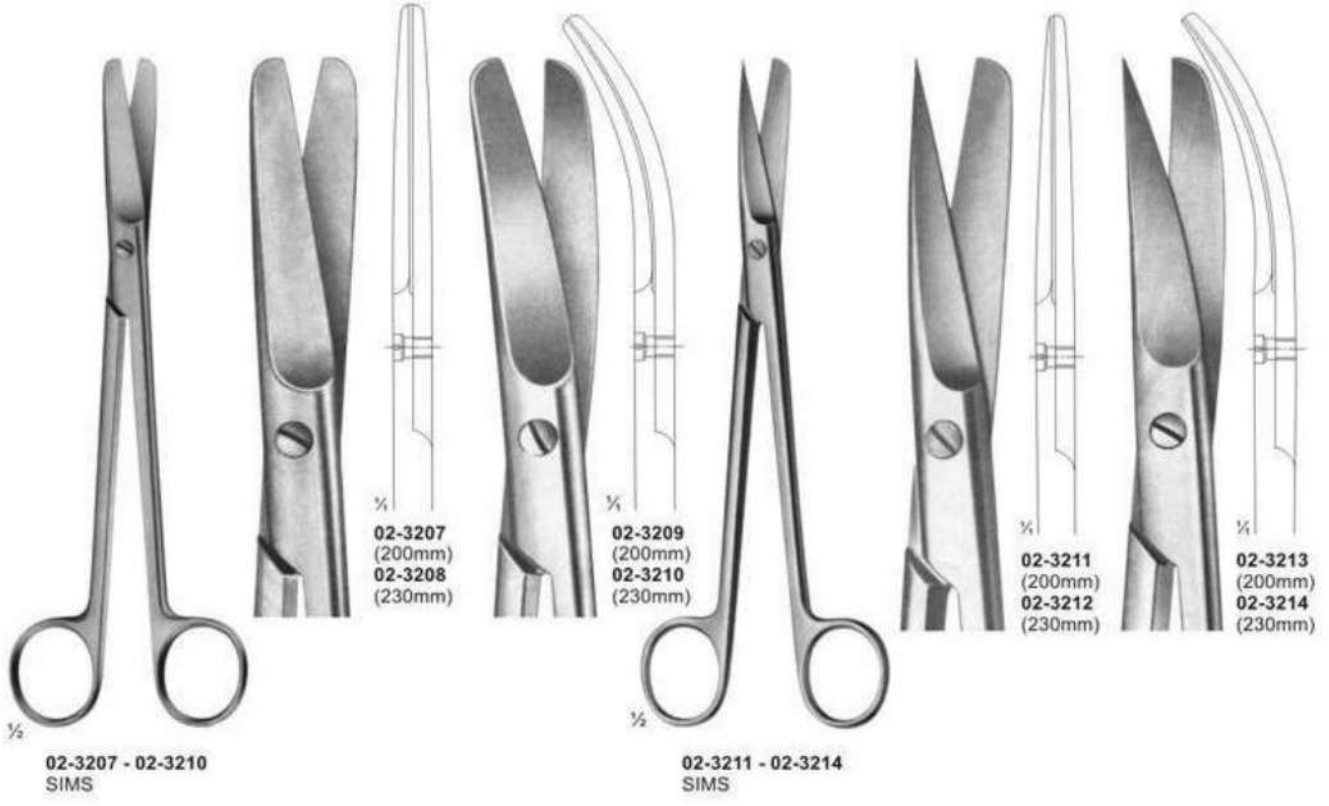

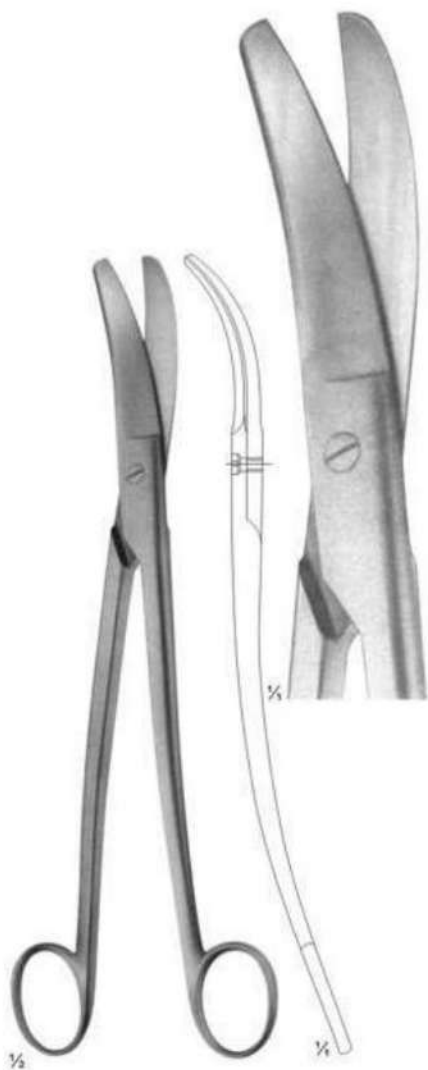

02-3220
SIEBOLD
Uterine Scissors
Size: 245 mm

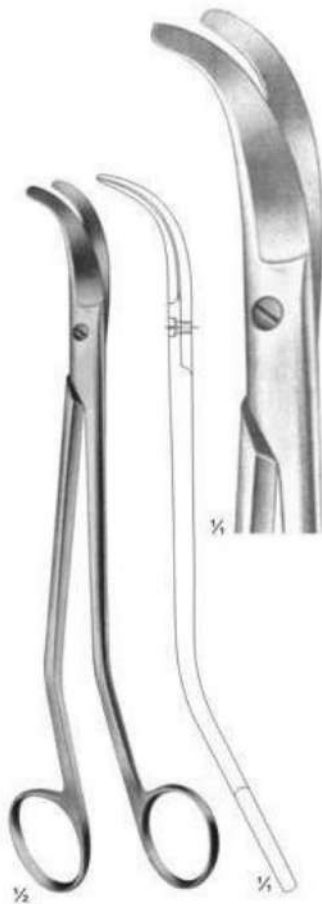

02-3221
BOZEMANN
Uterine Scissors
Size: 220 mm

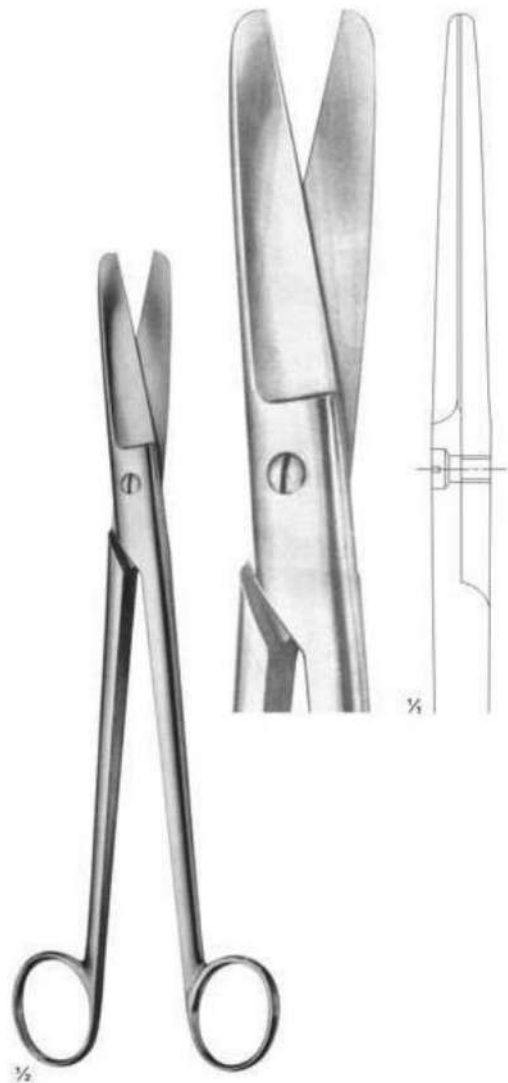

02-3222
SIMS-SIEBOLD
Uterine Scissors
Size: 250 mm



02-3223
SCHUMACHER
Umbilical Cord Scissors
Size: 155 mm

02-3224
Umbilical Cord Scissors
Size: 105 mm

02-3225
Umbilical Cord Scissors
135 mm



02-3226 - 02-3227
BRAUN-STADLER
Episiotomy Scissors

02-3226
145 mm

02-3227
200 mm

02-3228
Episiotomy Scissors
240 mm



02-3229
Bowel Scissors
Size: 210 mm

02-3230
Bowel Scissors
Size: 210 mm

02-3231
LLOYD-DAVIES
(GOLIGHER'S)
Rectal Scissors
Size: 270 mm

02-3232
STELZNER
Rectal Scissors
Size: 310 mm

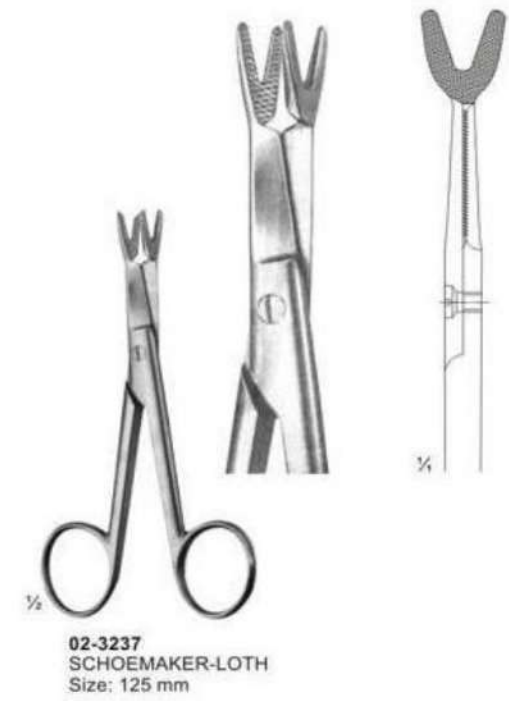
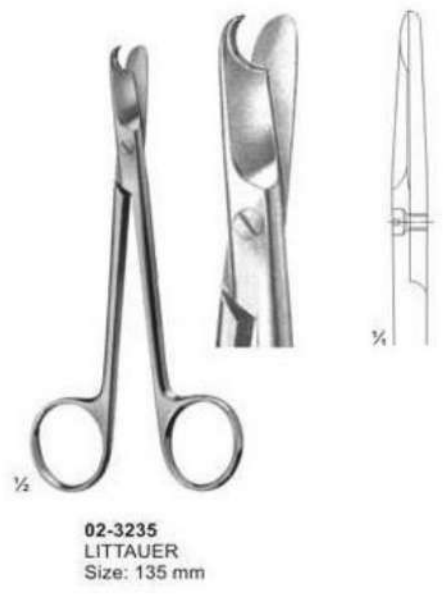



1/2

02-3238 - 02-3242
BEEBE
Size: 110 mm



02-3238



02-3239

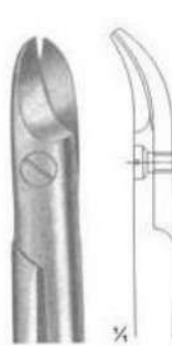

02-3240
Broad Blades

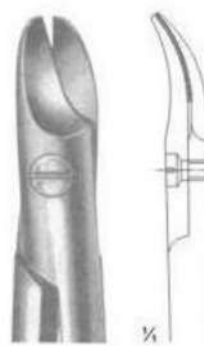

02-3241
1 Blade Serrated

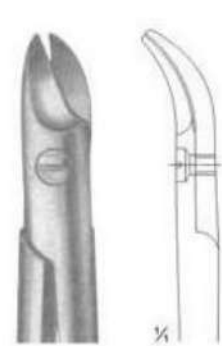

02-3242
NAUJOKS
Strongly Curved



1/2

02-3243
1 Blade Serrated
Size: 120 mm

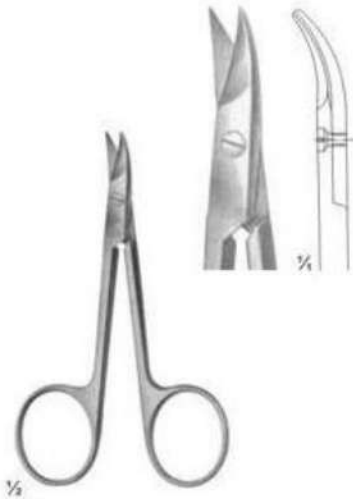

1/2

02-3244
STRACK
Size: 100 mm

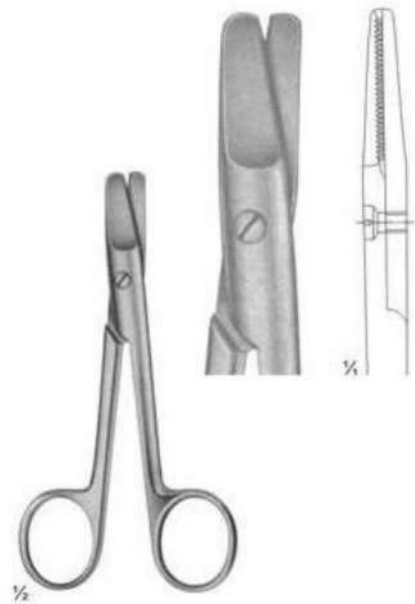

1/2

02-3245
HARVEY
blades serrated
Size: 125 mm

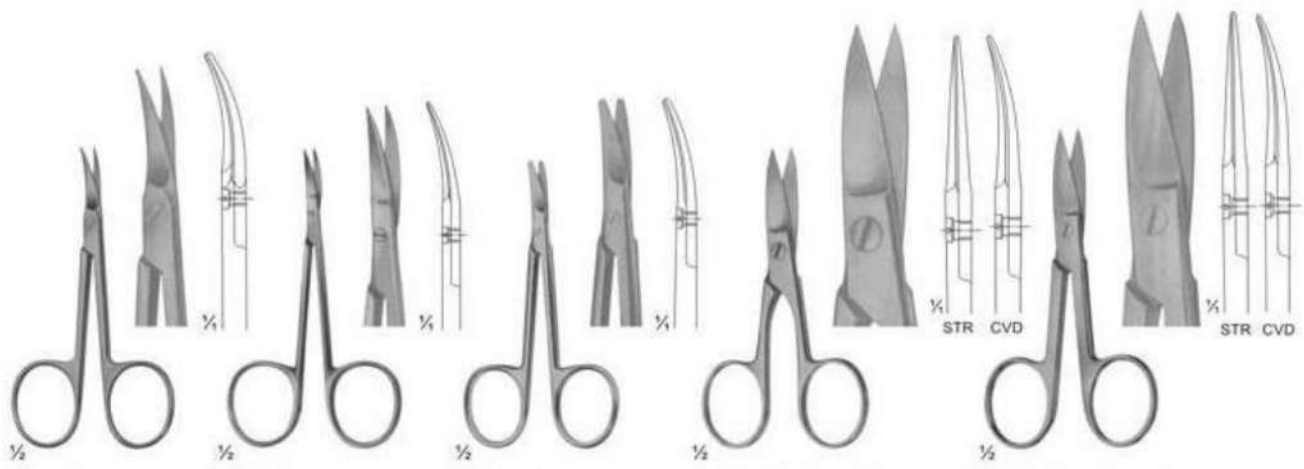

02-3246
NAIL SCISSORS
Size: 90 mm

02-3247
NAIL SCISSORS
especially fine pattern
Size: 90 mm

02-3248
BABY NAIL
SCISSORS
Size: 85 mm

02-3249 - 02-3252
NAIL SCISSORS
02-3249(90mm)straight
02-3250(90mm)curved
02-3251(100mm)straight
02-3252(110mm)curved

02-3253 - 02-3255
NAIL SCISSORS
02-3253(95mm)straight
02-3254(95mm)curved
02-3255(105mm)straight



02-3256
KNOWLES
Size: 140 mm

02-3257
KNOWLES
Size: 145 mm

02-3258
Size: 150 mm

02-3259
SMITH
Size: 180 mm

02-3260
BANDAGE CUTTING
SCISSORS
Size: 310 mm



1/2
02-3261
UNIVERSAL BANDAGE & CLOTH SCISSORS,
WITH TOOTHED EDGES, AUTO CLEAVABLE up to 143 °C
180 mm



1/2
02-3262
LISTER BANDAGE & CLOTH
SCISSORS, WITH TOOTHED EDGES,
AUTO CLEAVABLE up to 143 °C
Size: 145 mm

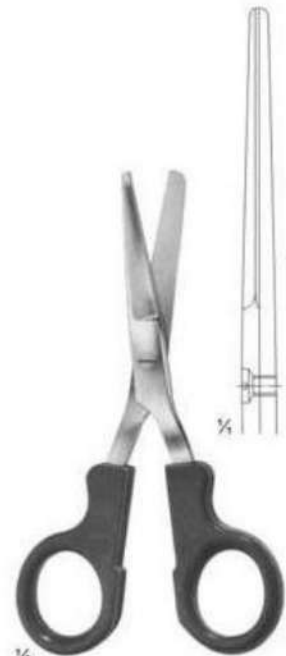

1/2
02-3263
NURSE'S SCISSORS
Size: 145 mm
AUTO CLEAVABLE up to 143 °C

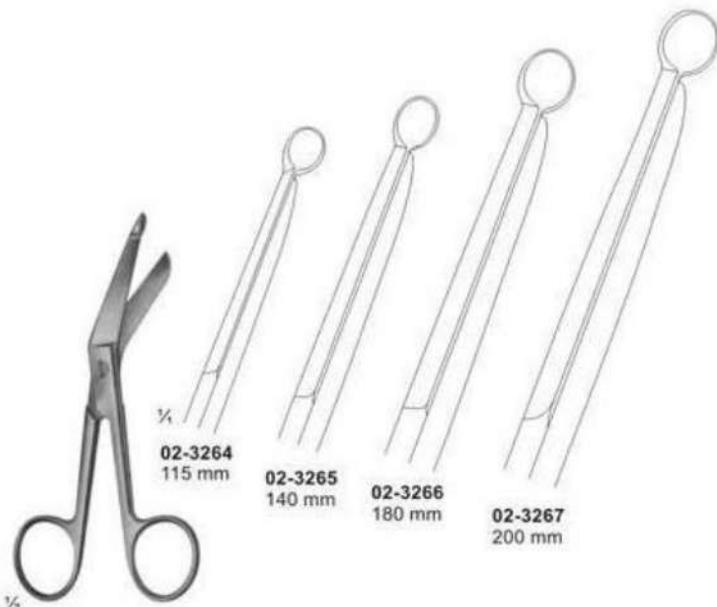

1/2
02-3264 - 02-3267
LISTER

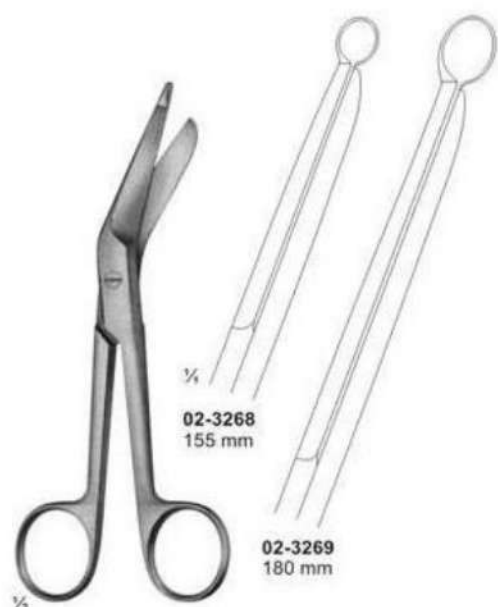

1/2
02-3268 - 02-3269
LISTER



02-3270
CLOTH SCISSORS
205 mm



02-3271
BRAUN-STADLER
Bandage scissors
225 mm



02-3272
SEUTIN
Plaster scissors
230 mm



02-3273 - 02-3274
ESMARCH (Plaster scissors)



02-3275
BRUNS
Plaster scissors
235 mm



02-3276
BANDAGE SCISSORS
235 mm

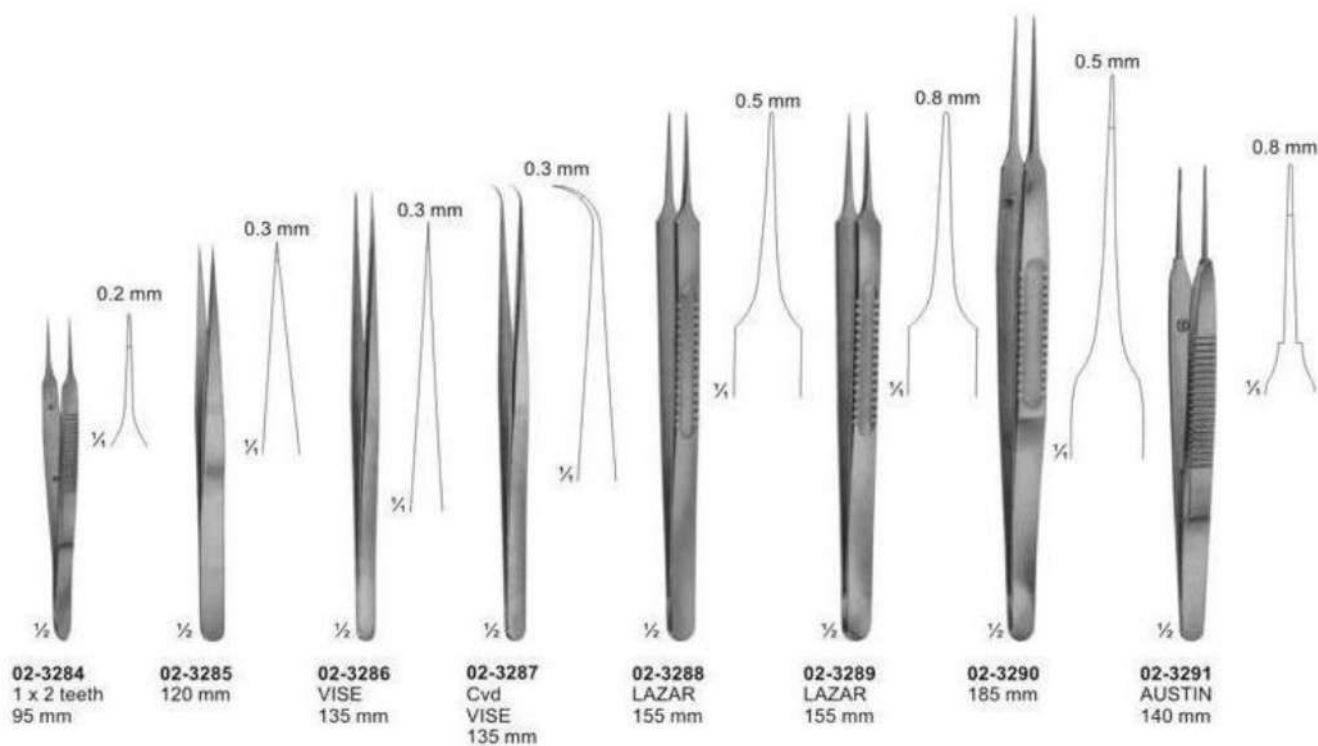
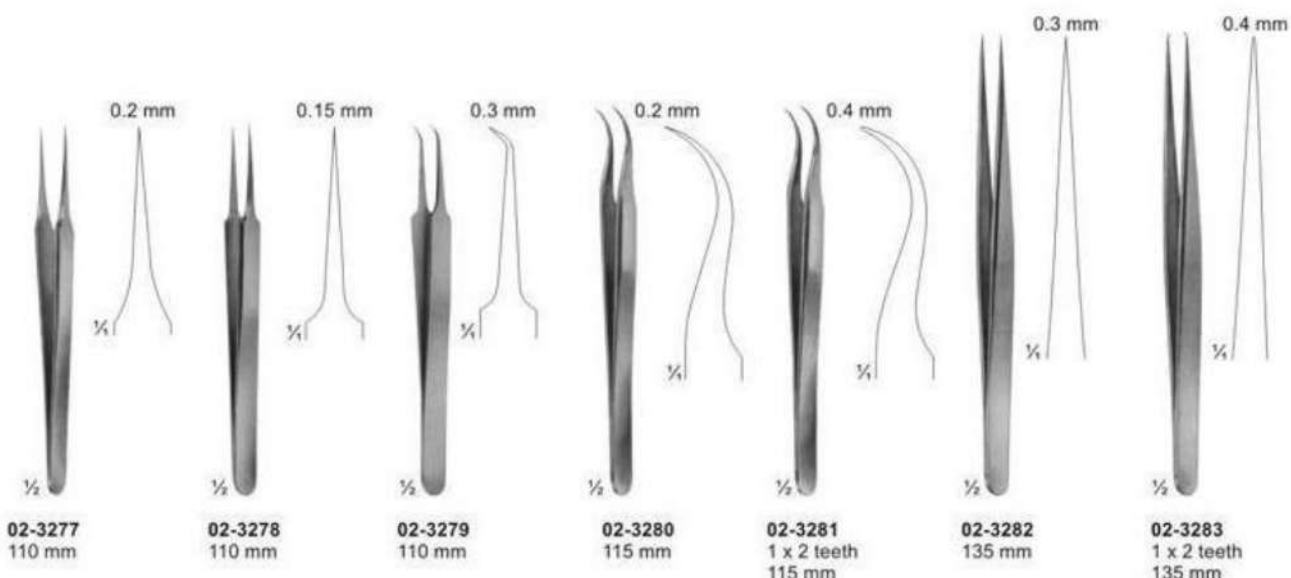

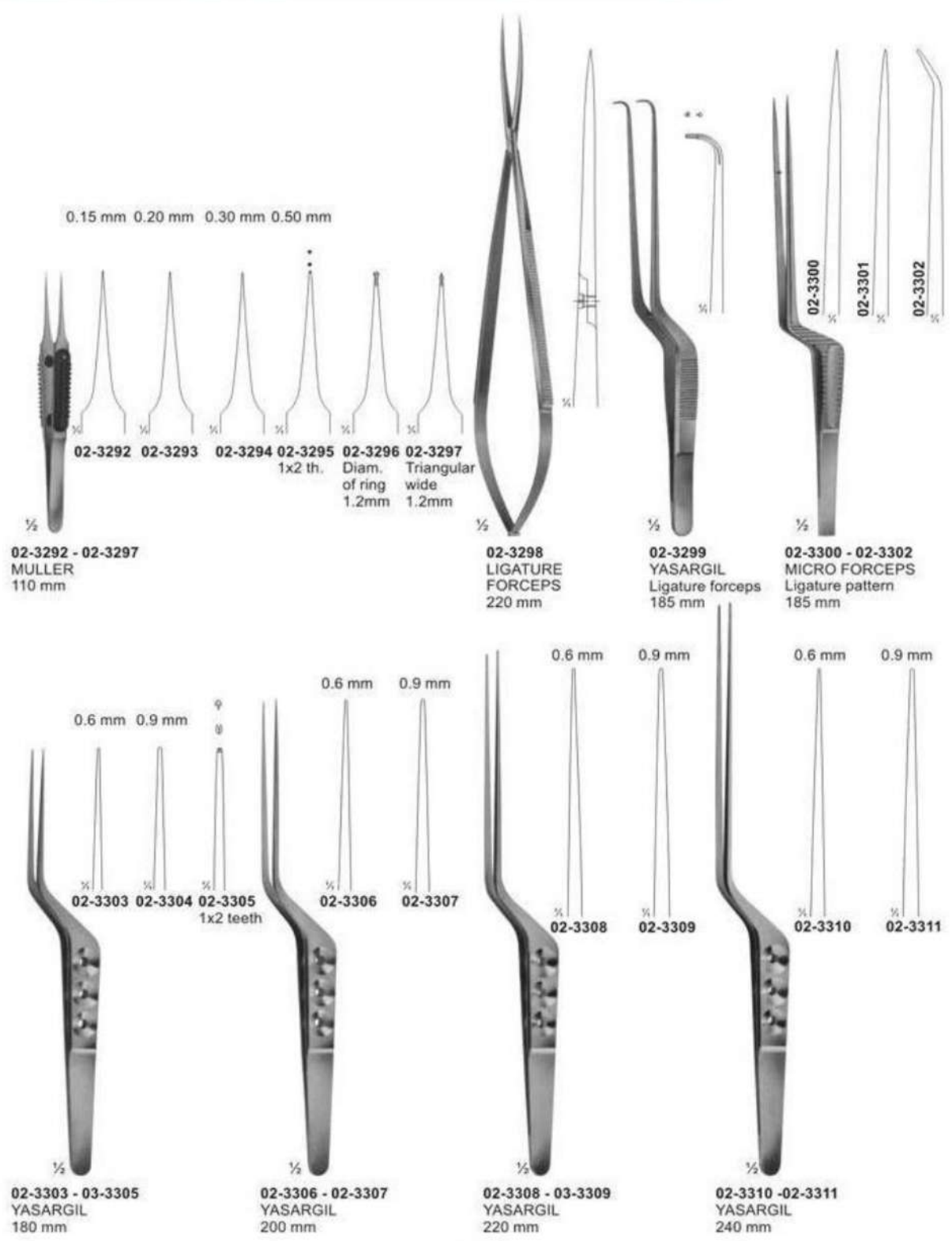

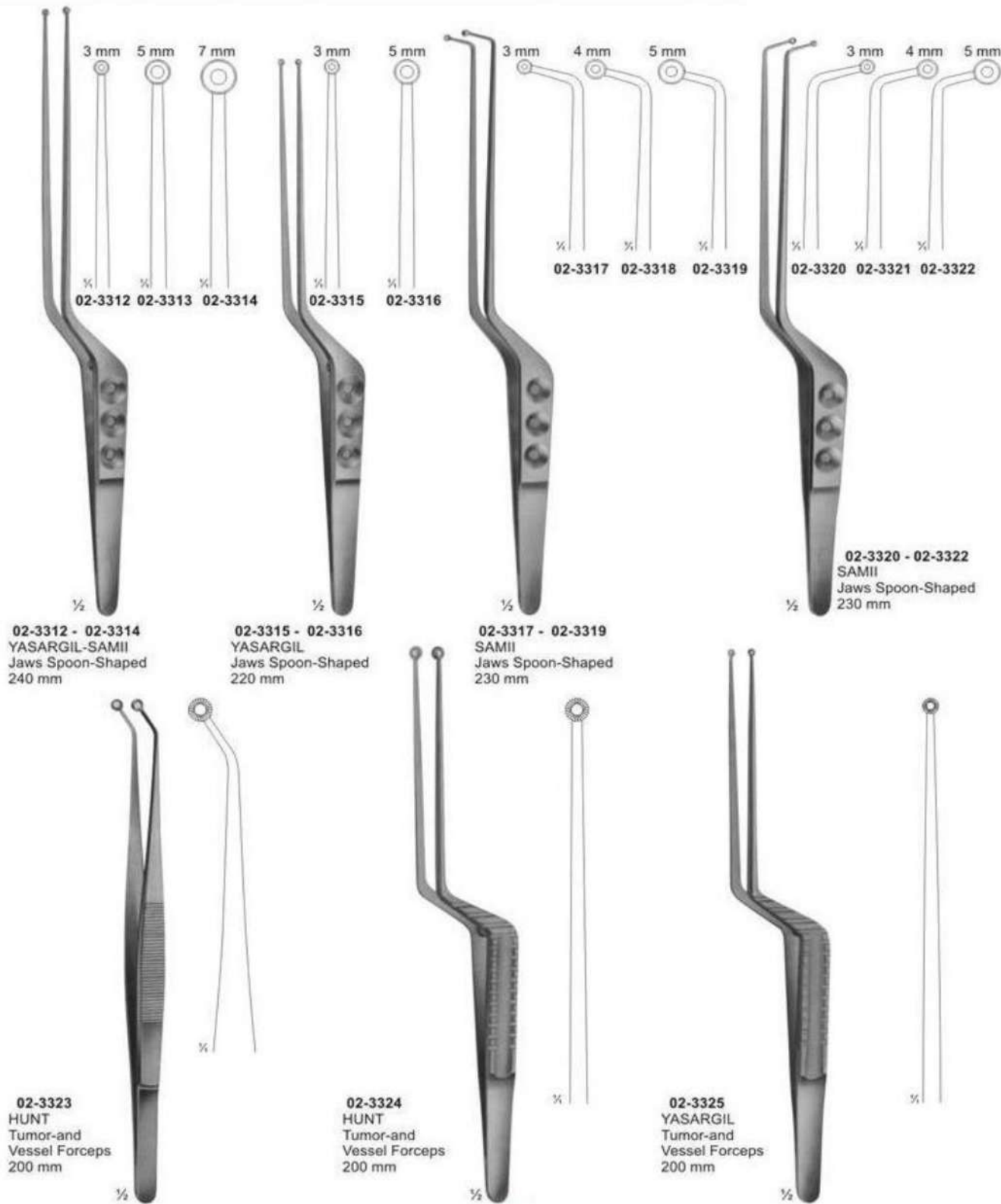



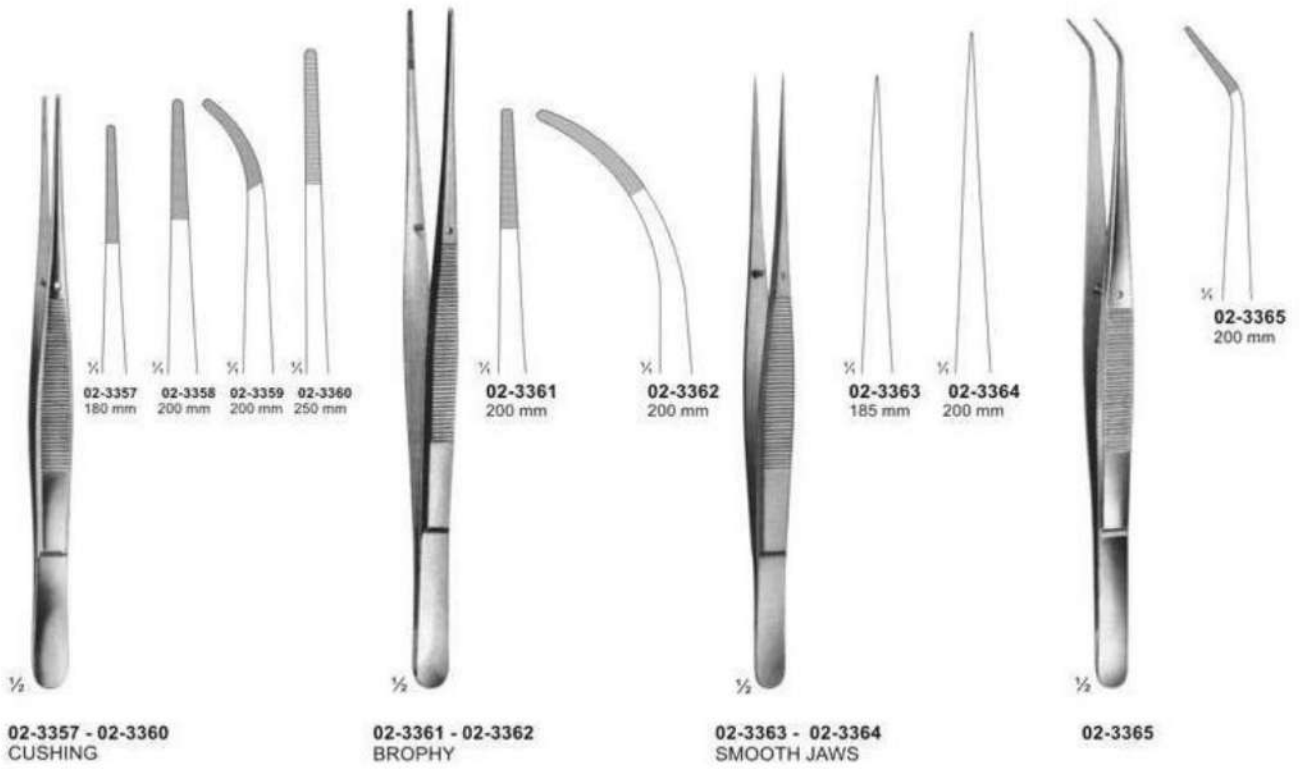
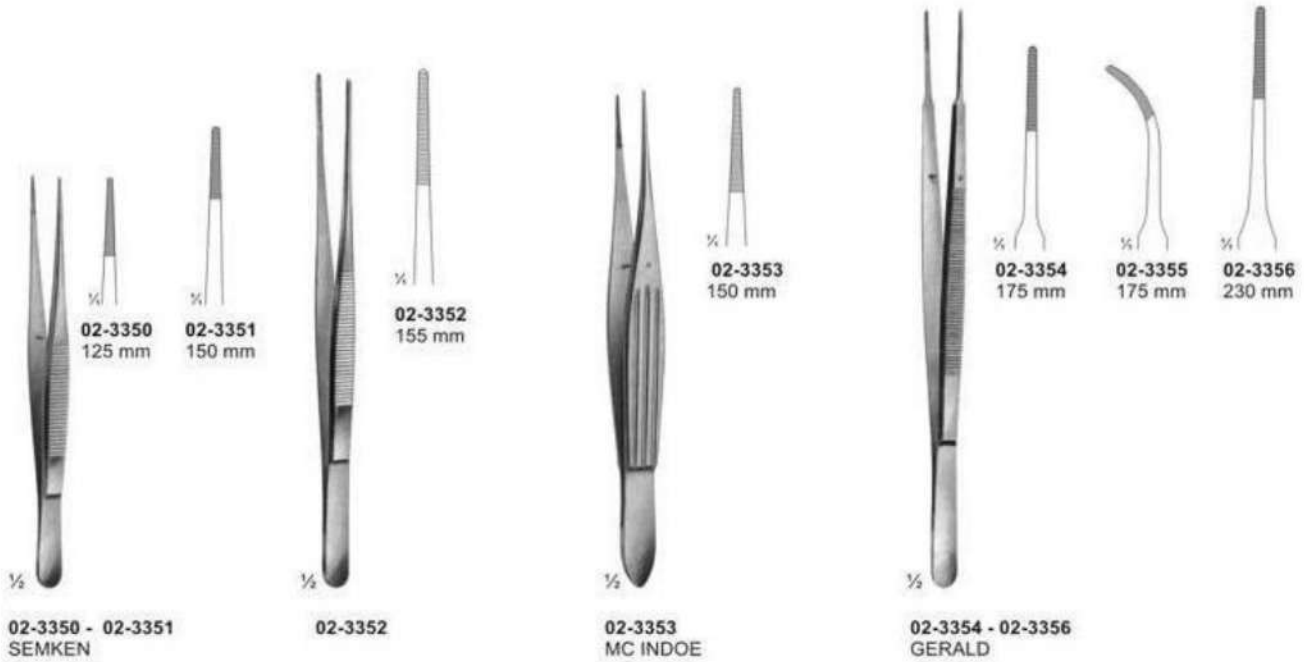

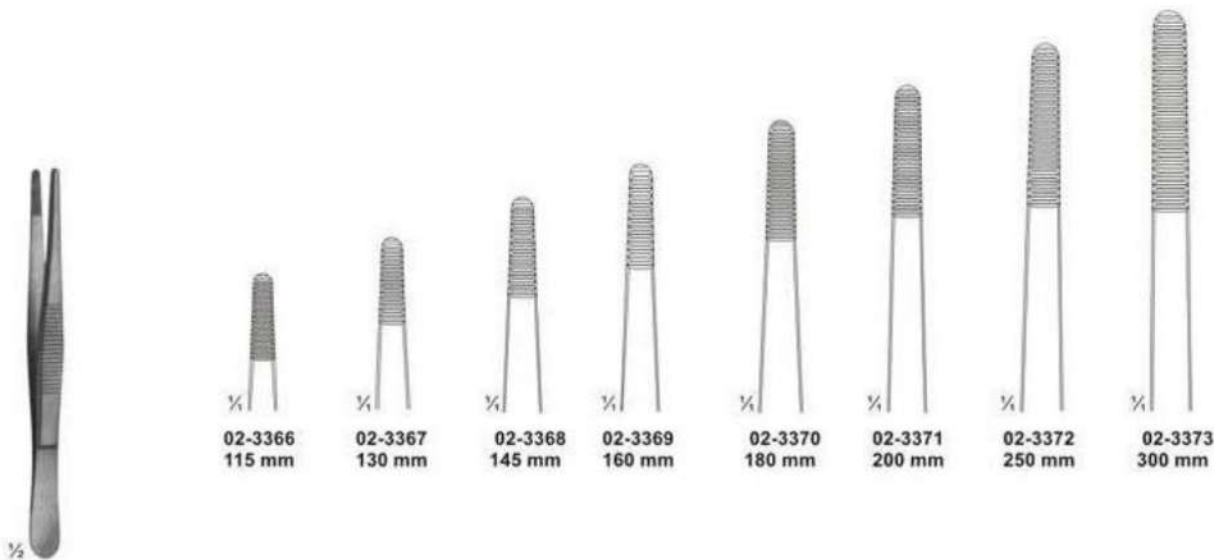

02-3366 - 03-3373
STANDARD



02-3374 - 02-3378
MEDIUM

02-3379 - 02-3380
MEDIUM



02-3381
125 mm



02-3382
155 mm



02-3383
130 mm



02-3384
150 mm



02-3385
170 mm



02-3386
200 mm



02-3381 - 02-3382

02-3383 - 02-3386
Swedish pattern



02-3387
OCHSNER
Ligature forceps
145mm



02-3388
FRICKE
Artery forceps
130mm



03-3389
BONNEY
175mm



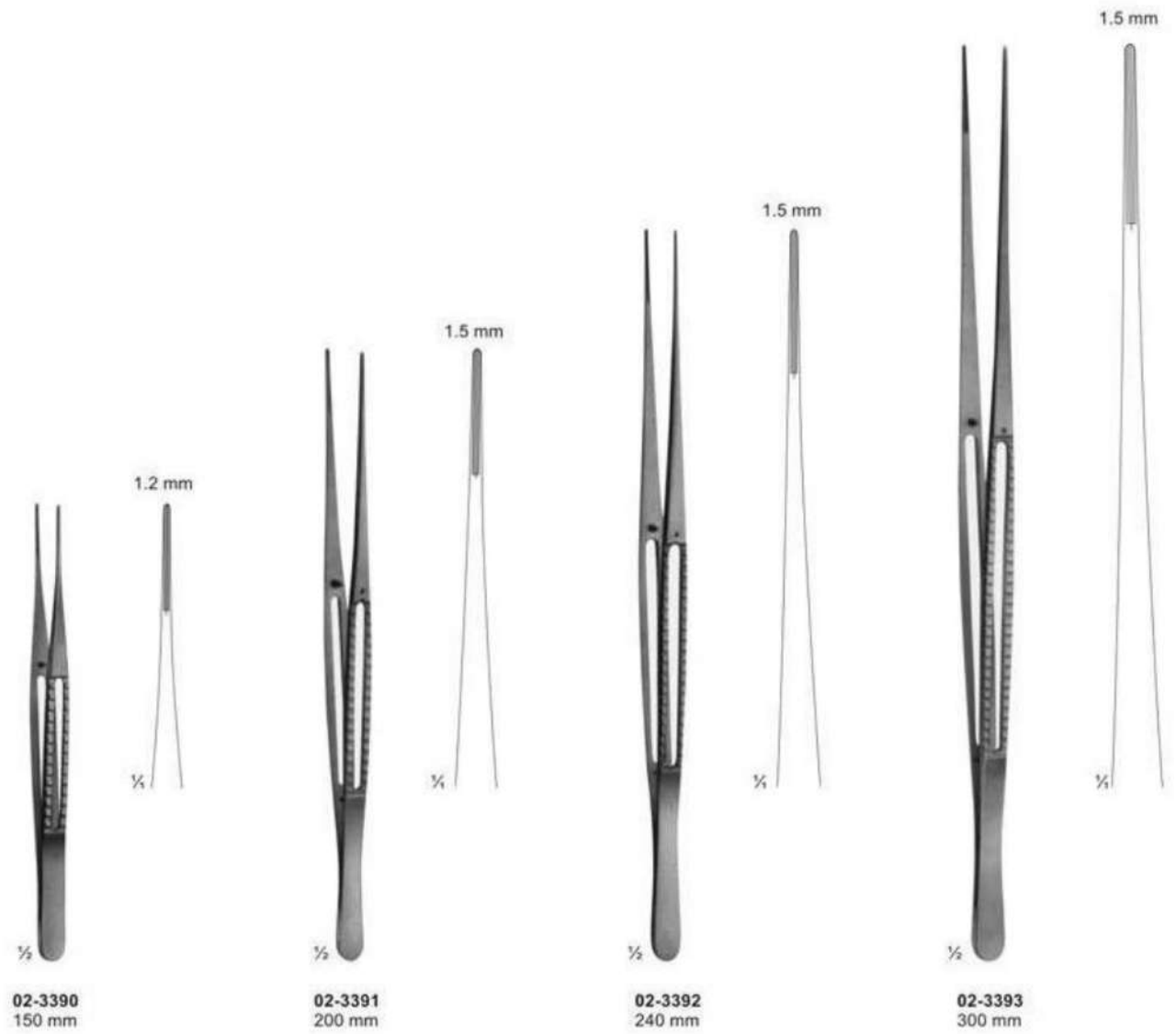

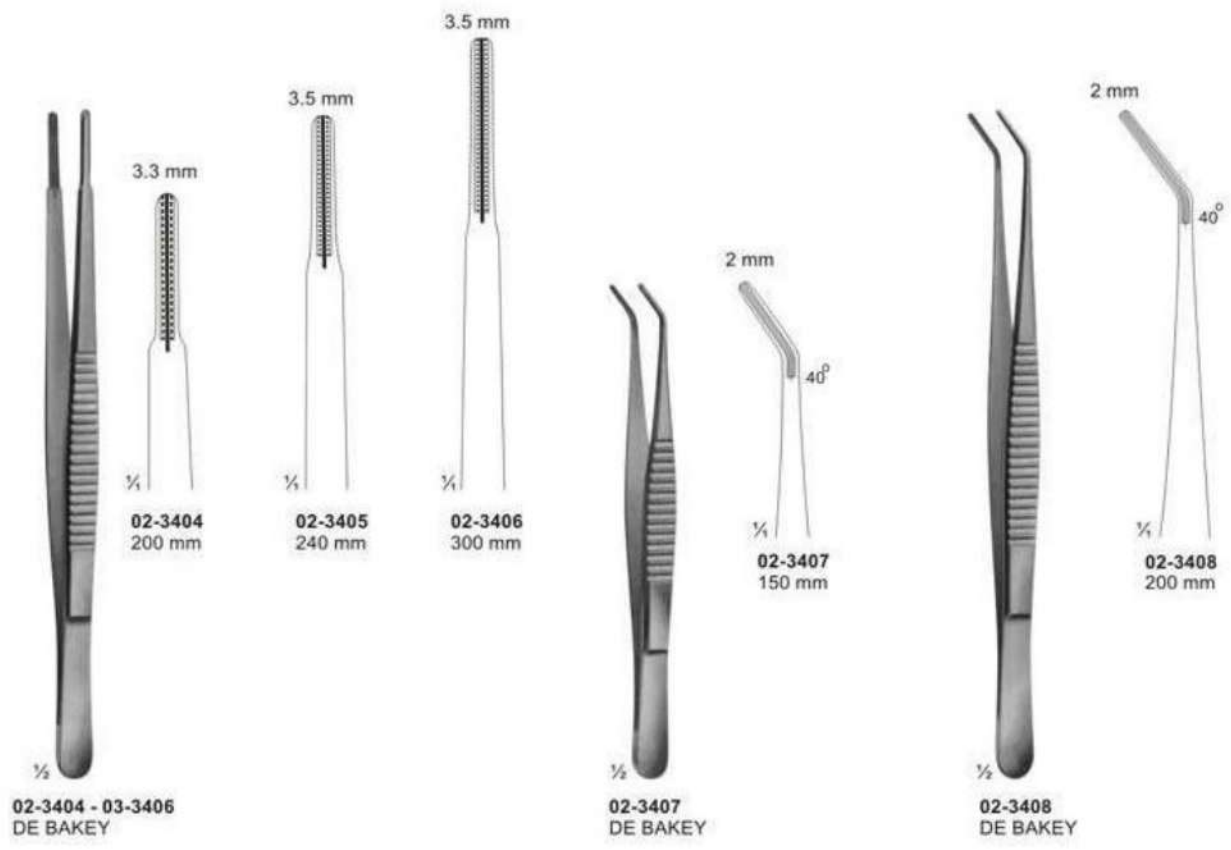
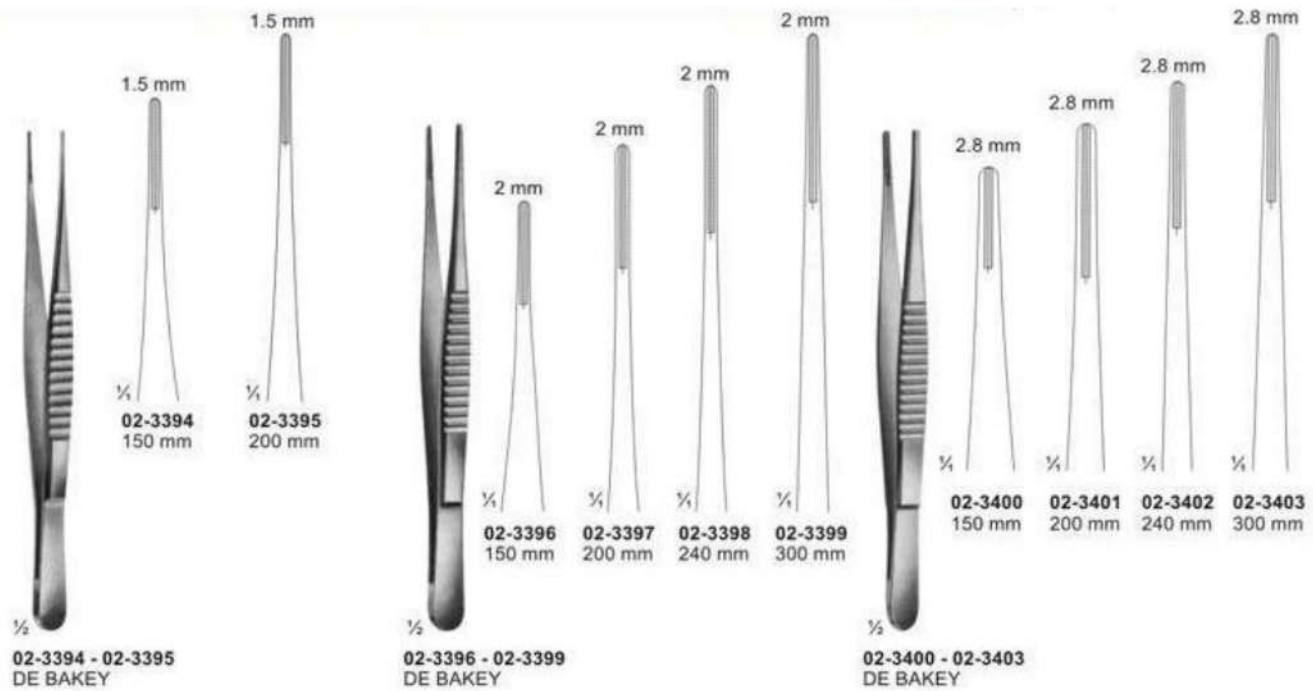

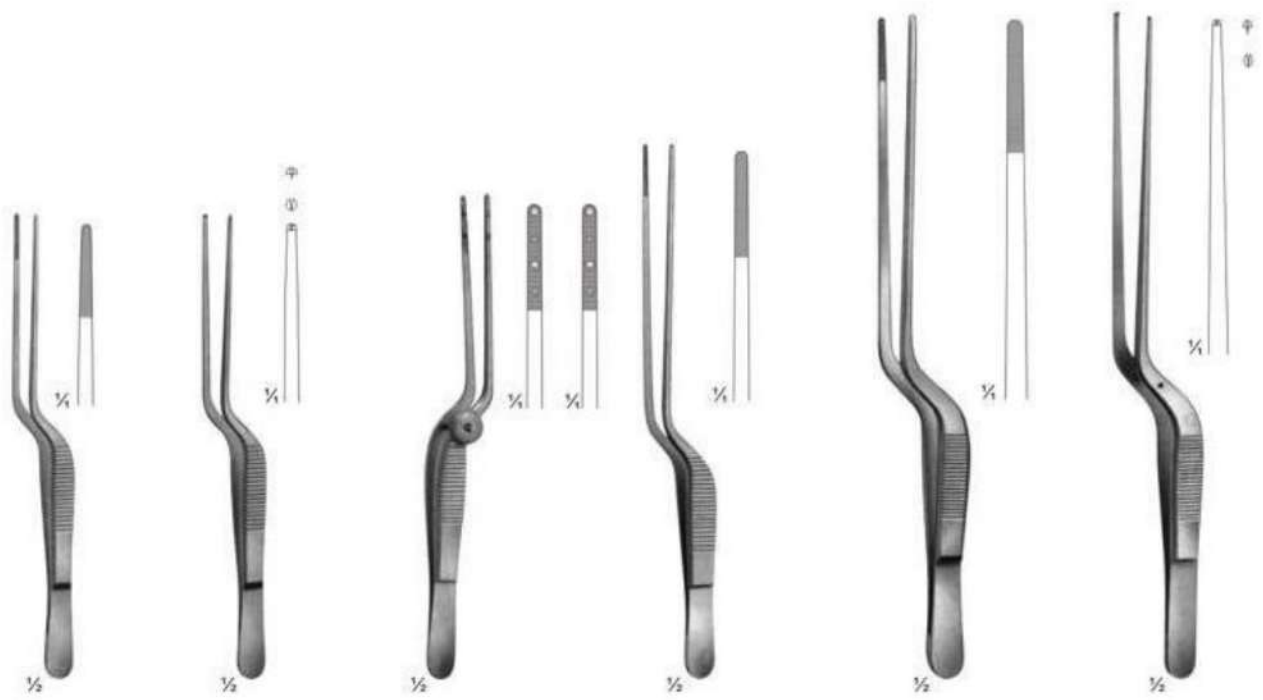

02-3409
LUCAE
140 mm

02-3410
LUCAE
1x2 teeth
140 mm

02-3411
COTTLE
Forceps with
jaws toothed
and serrated
140 mm

02-3412
JANSEN
160 mm

02-3413
GRUENWALD
200 mm

02-3414
1x2 teeth
200 mm

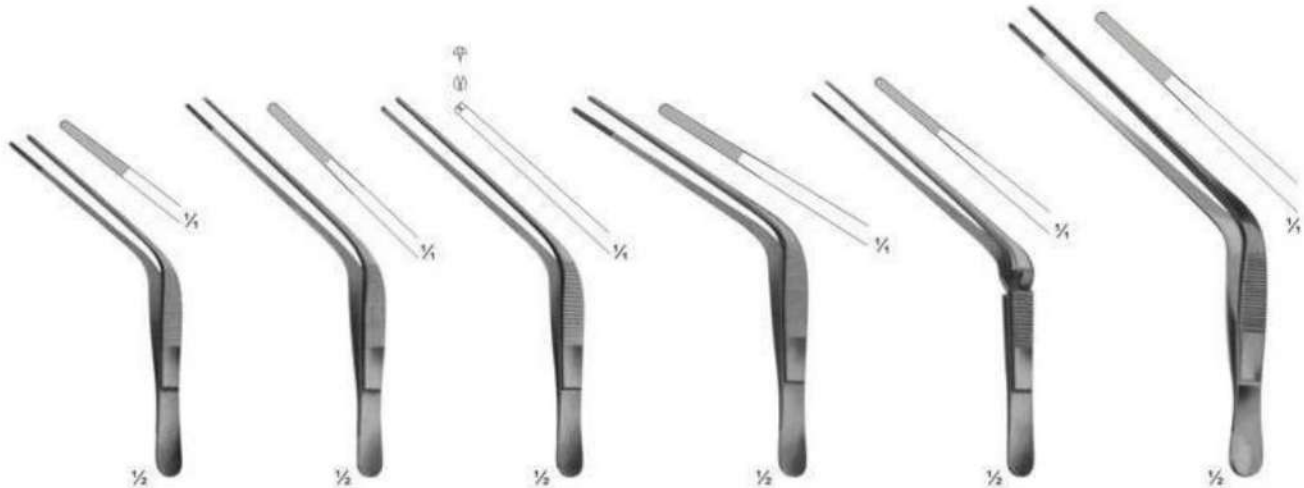

02-3415
TROELTSCH
100 mm

02-3416
TROELTSCH
115 mm

02-3417
TROELTSCH
1X2 teeth
115 mm

02-3418
WILDE
115 mm

02-3419
TROELTSCH
Cross action
120 mm

02-3420
TROELTSCH
140 mm

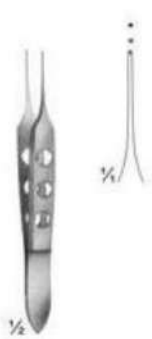

02-3421
BISHOP-HARMON
85 mm

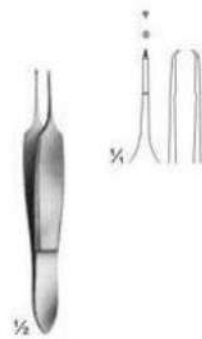

02-3422
ST. MARTIN
80 mm

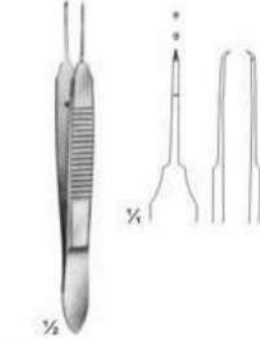

02-3423
CASTROVIEJO
teeth 0.9 mm
100 mm

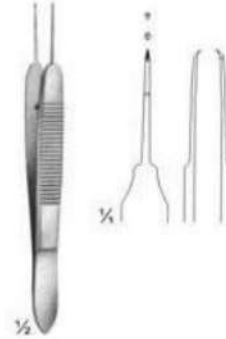

02-3424
CASTROVIEJO
teeth 0.5 mm
100 mm



02-3425
ELSCHING
110 mm



02-3426
GILL
75 mm



02-3427
GILL - HESS
75 mm

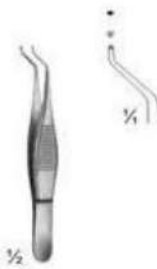

02-3428
HESS
70 mm



02-3429
ARRUGA
100 mm

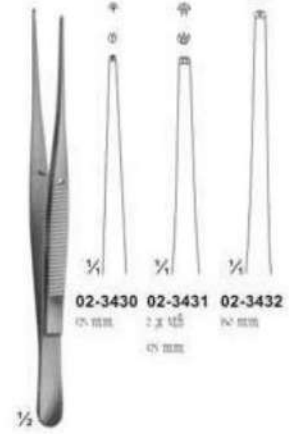

02-3430 - 02-3432
SEMKEN



02-3433
MICRO-ADSON
120 mm



02-3434
ADSON
120 mm

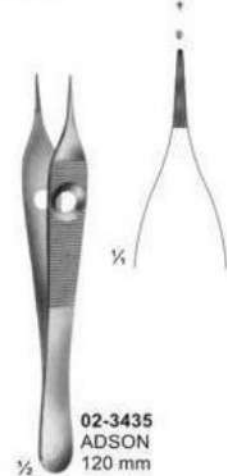

02-3435
ADSON
120 mm



02-3436
ADSON
120 mm

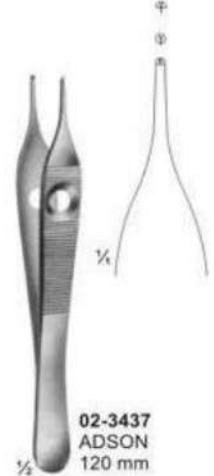

02-3437
ADSON
120 mm



02-3438
ADSON - BROWN
Non-traumatic
120 mm

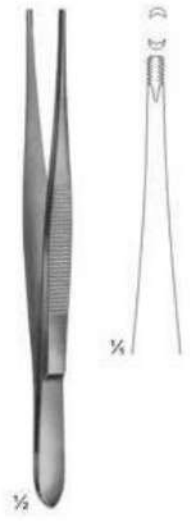

02-3439
BROWN
150 mm



02-3440
GRAEFE
110 mm

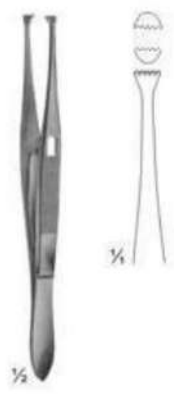

02-3441
GRAEFE
With Catch
110 mm

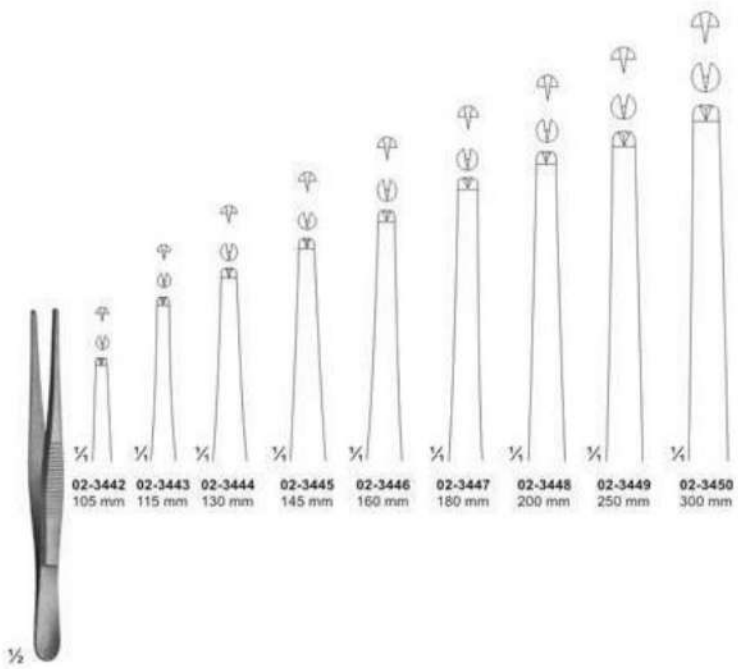

02-3442 - 02-3450
STANDARD

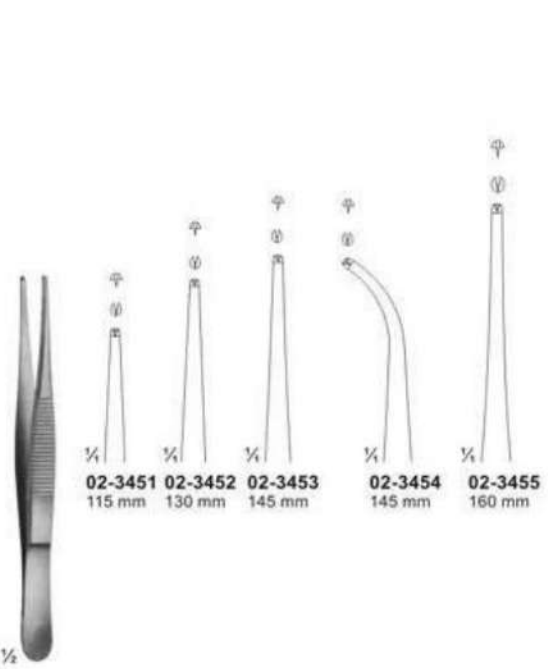

02-3451 - 02-3455
Medium

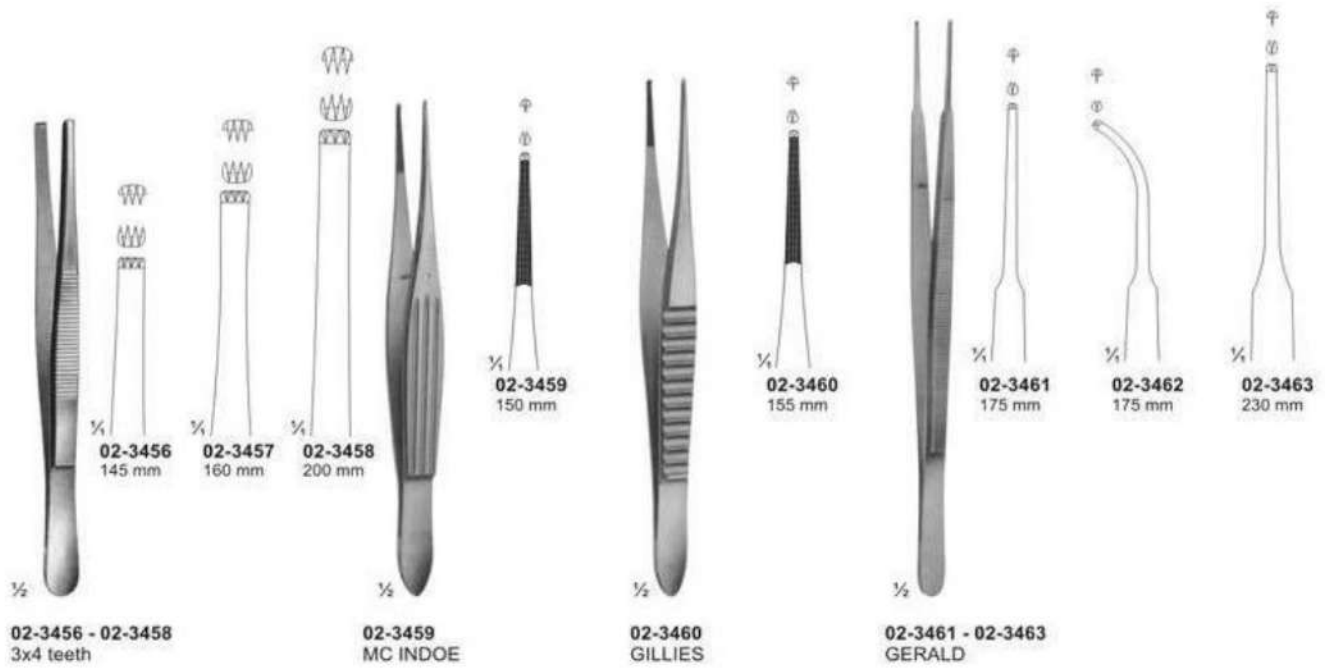

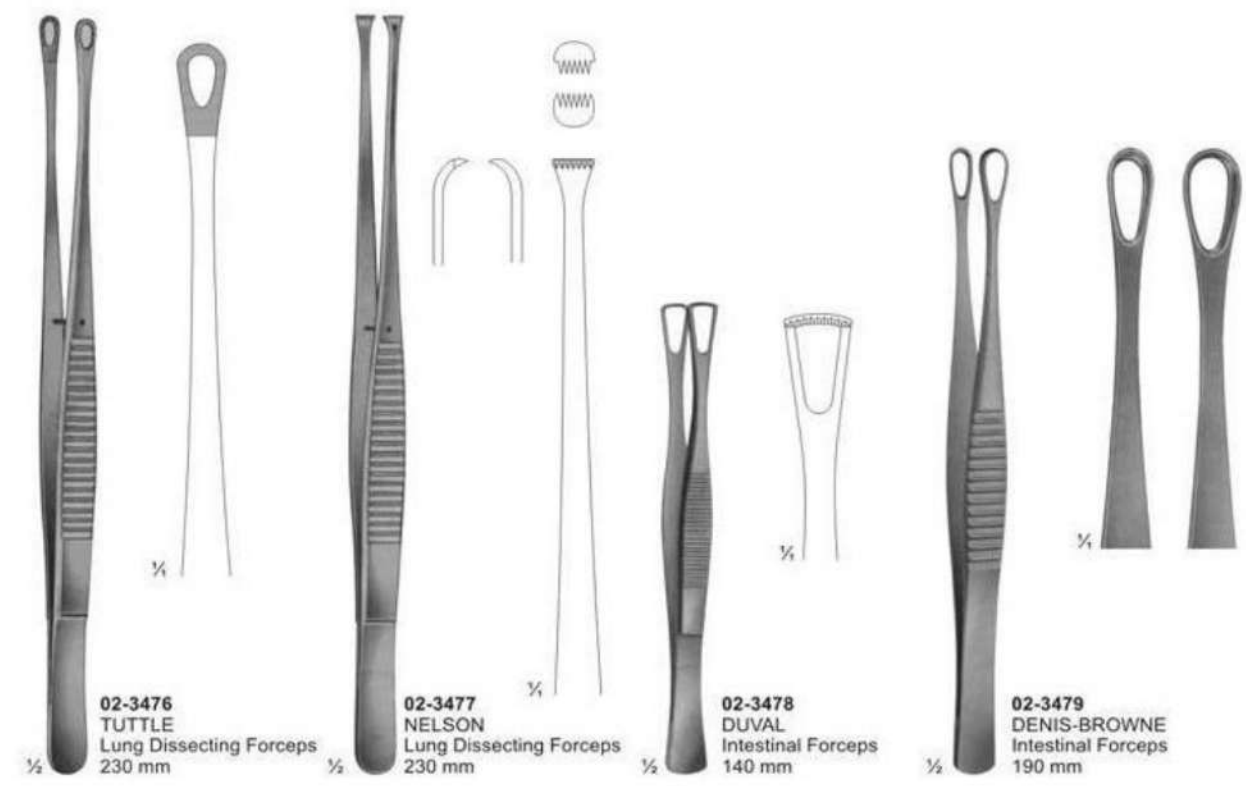
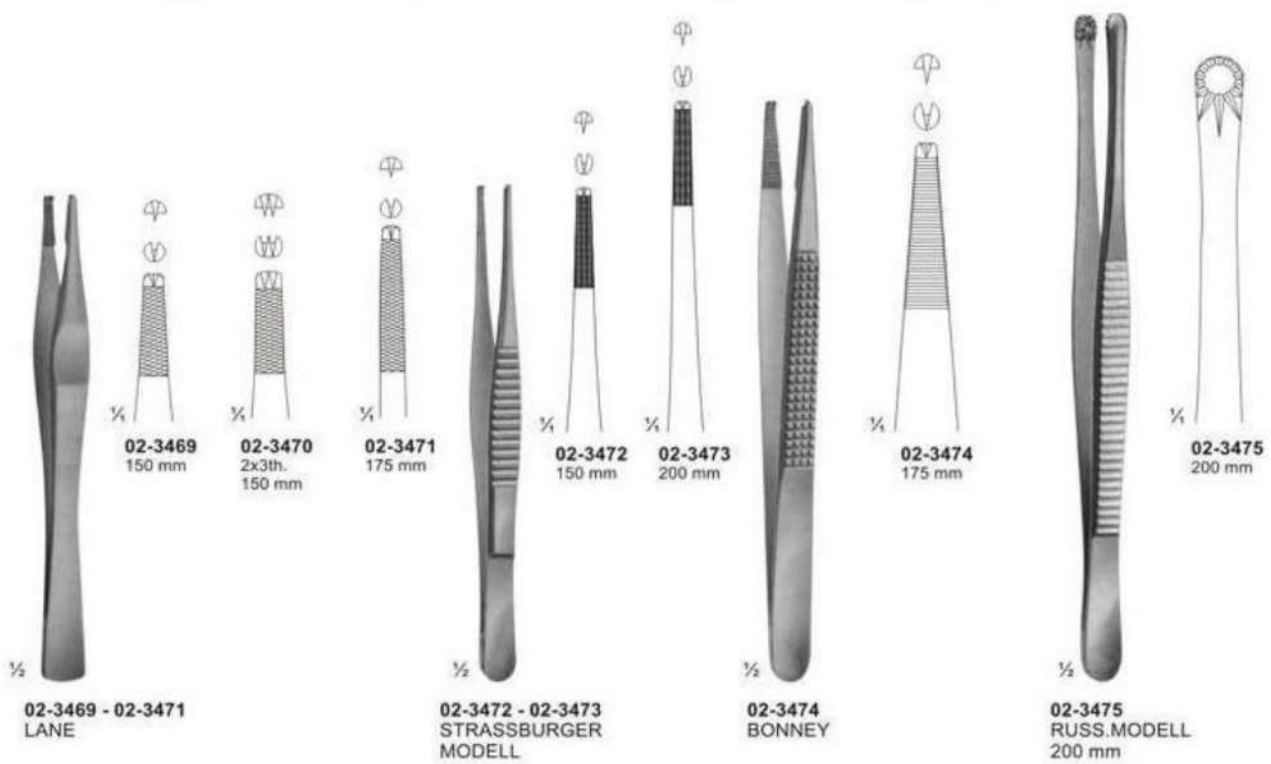

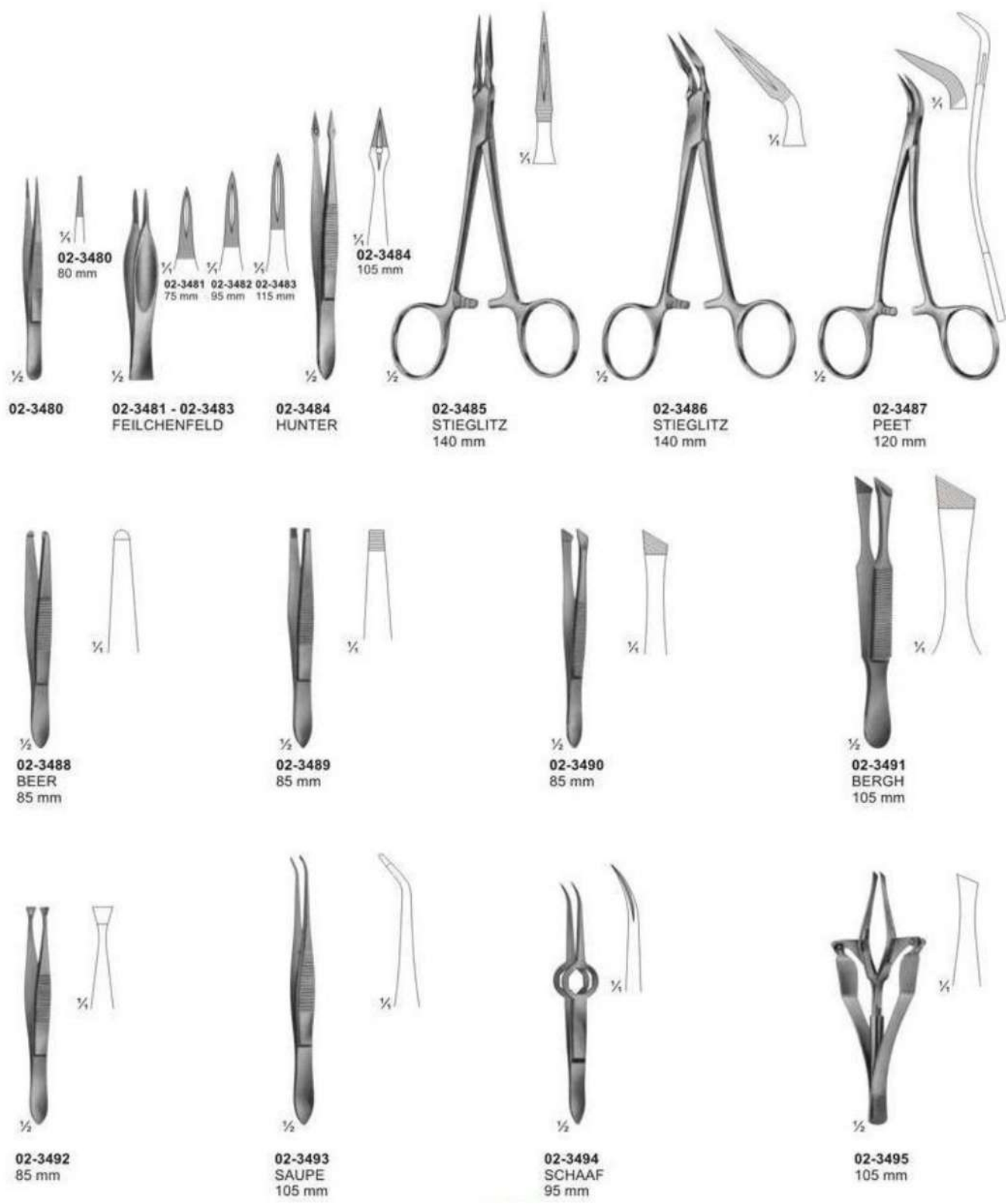

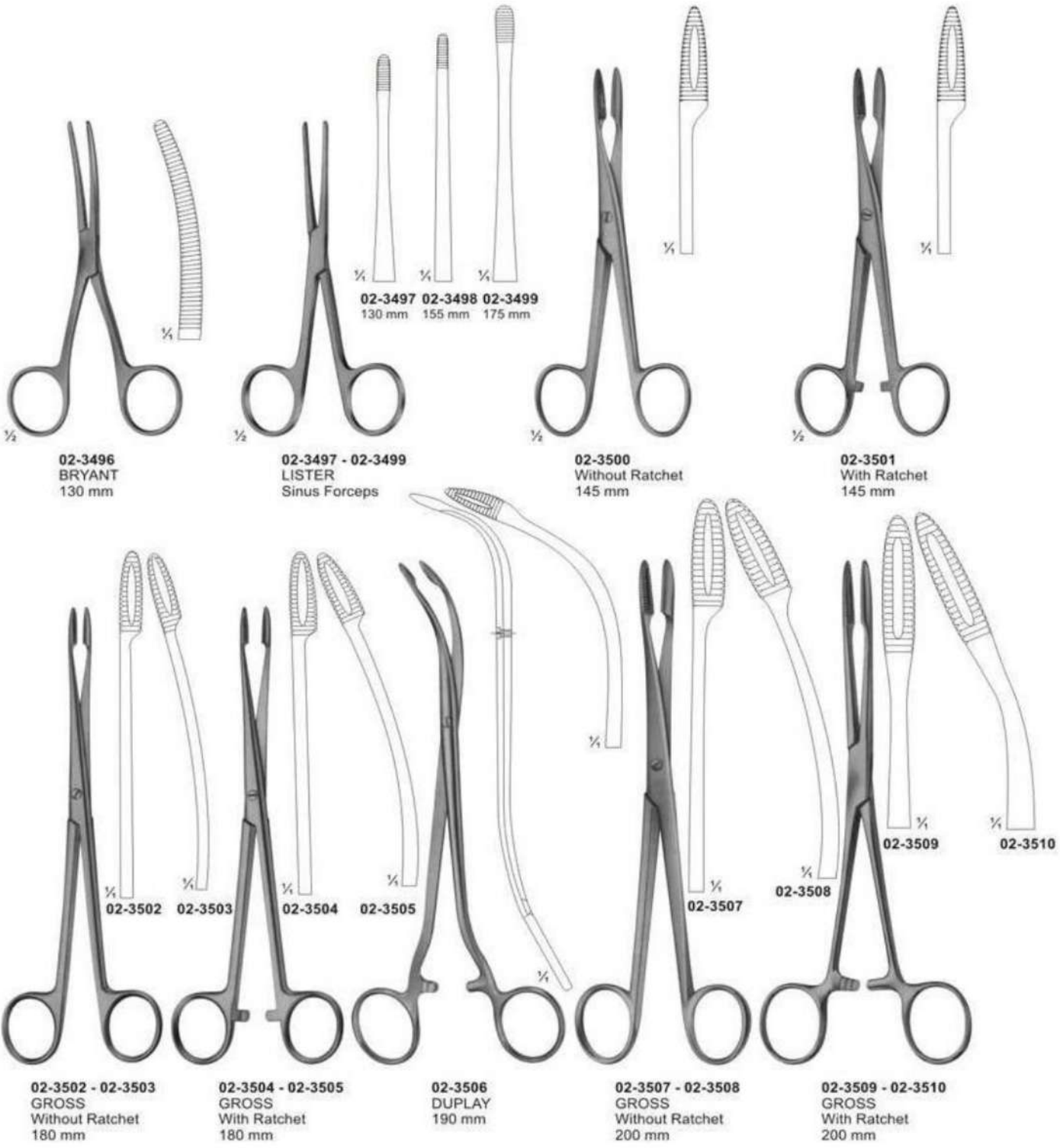

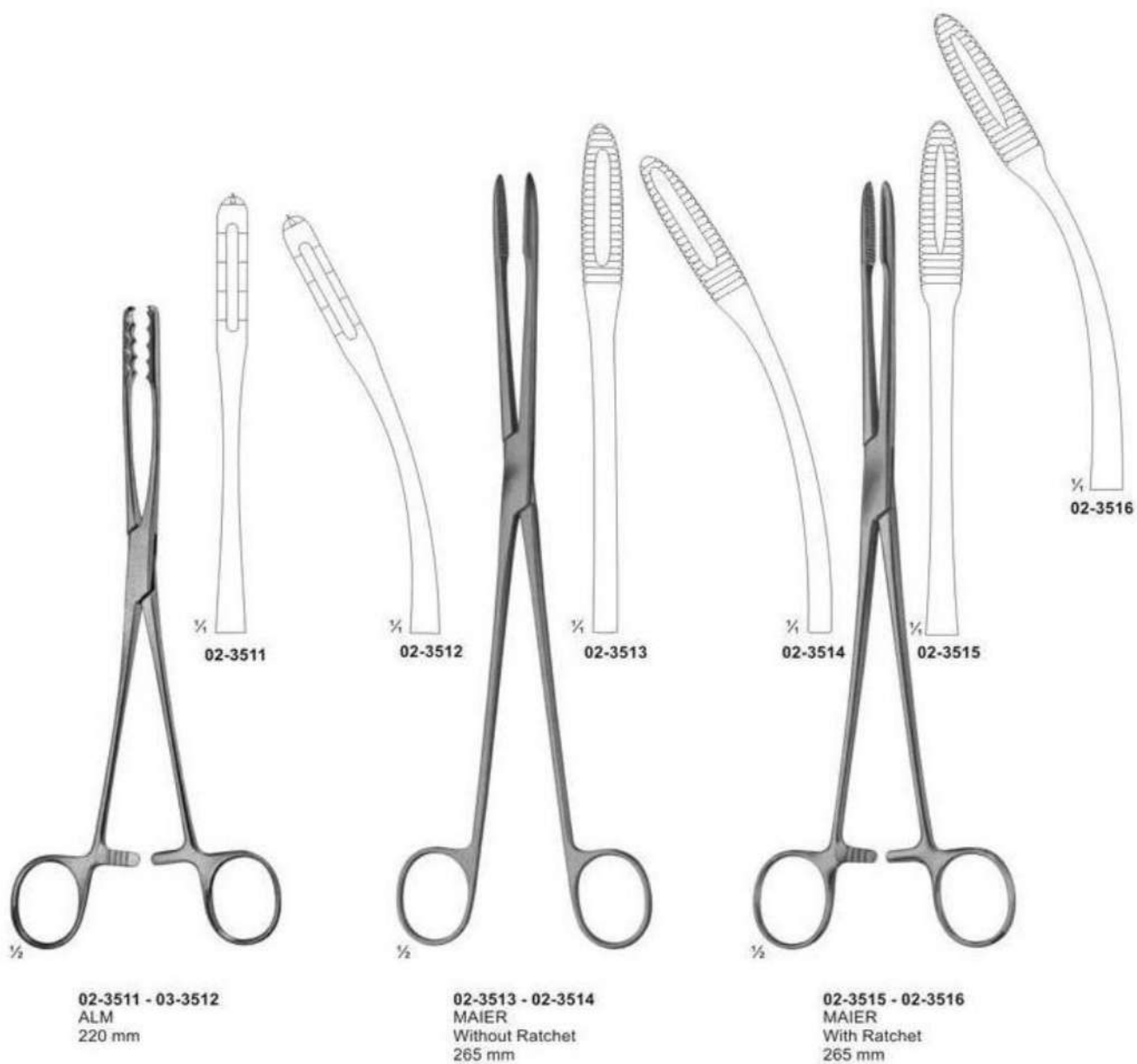

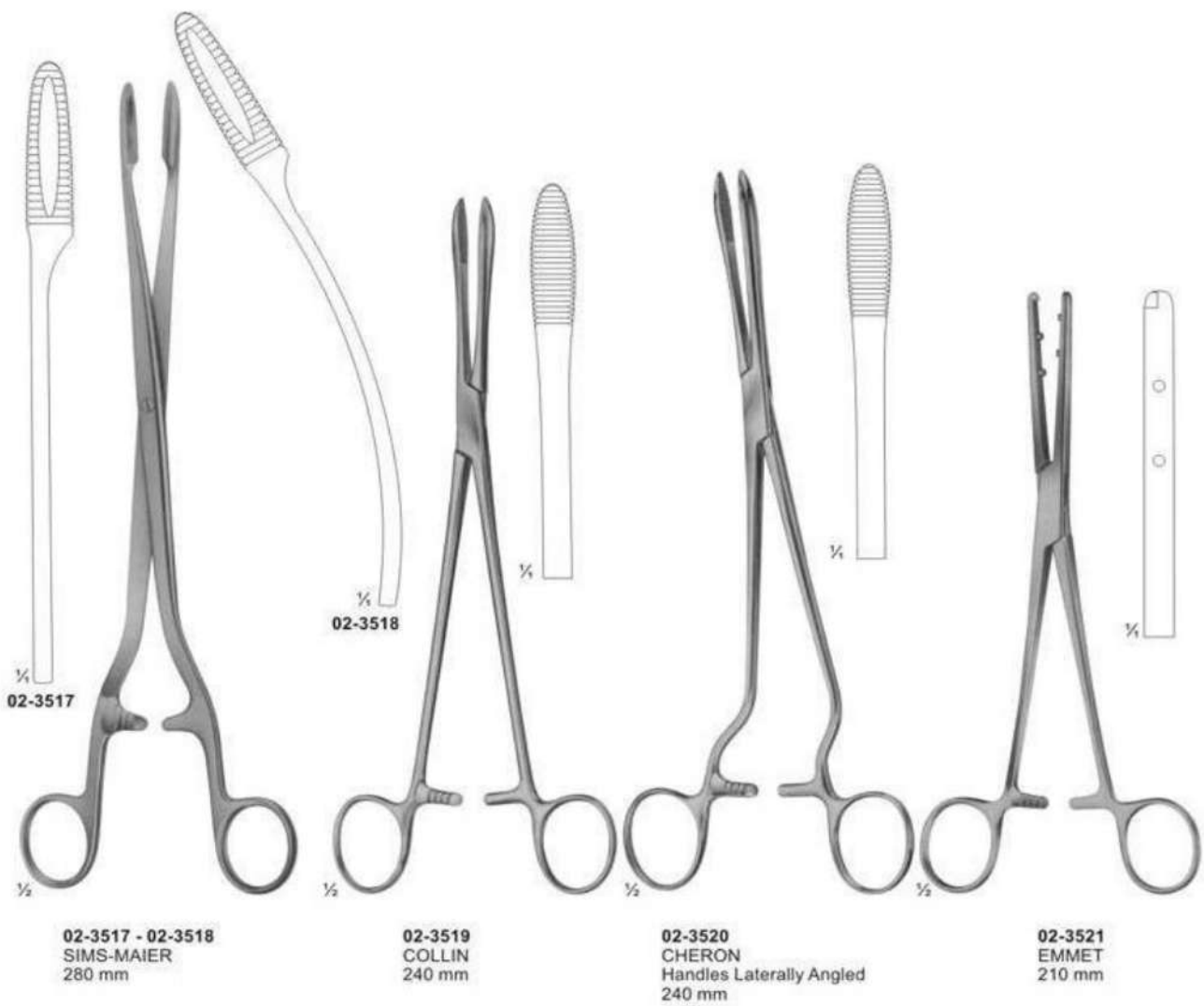

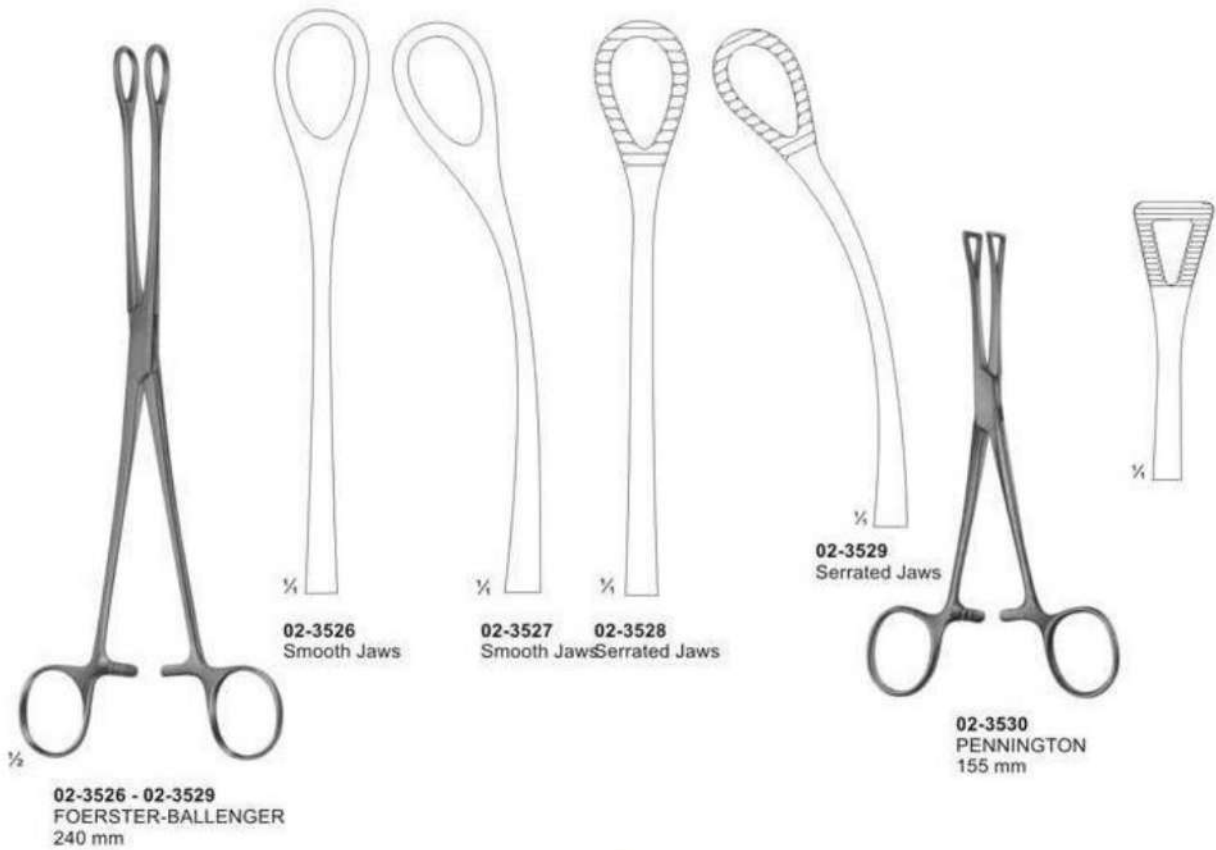
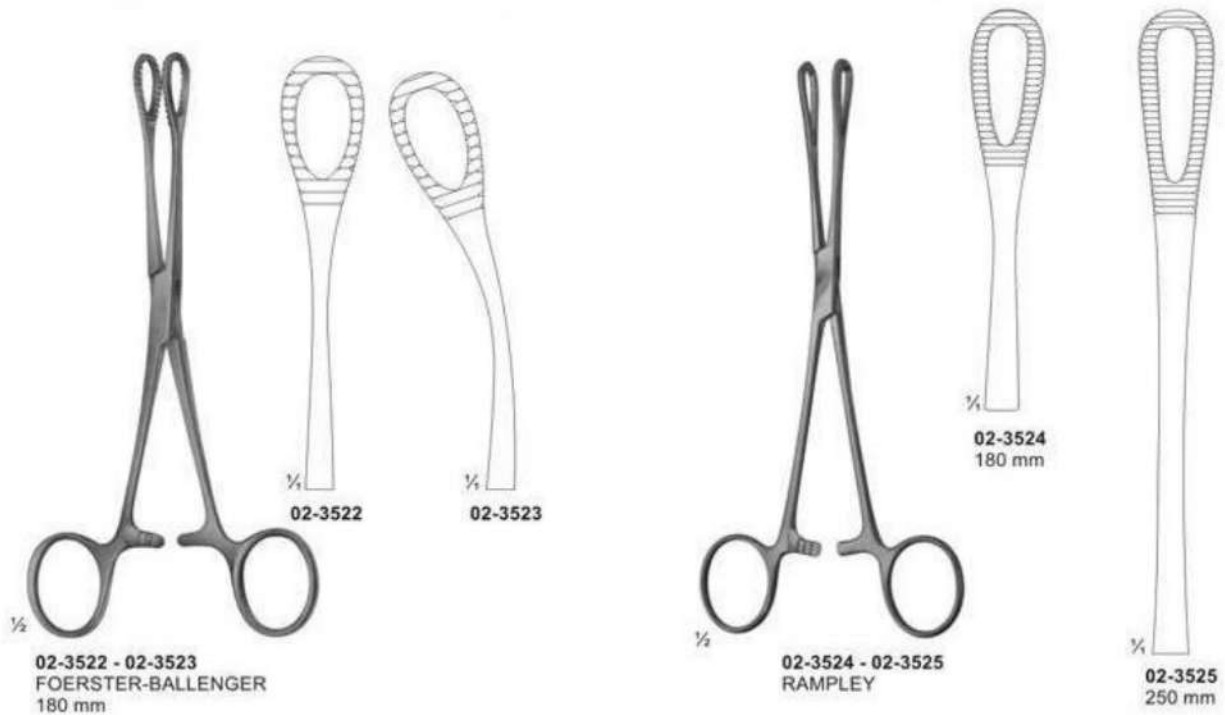

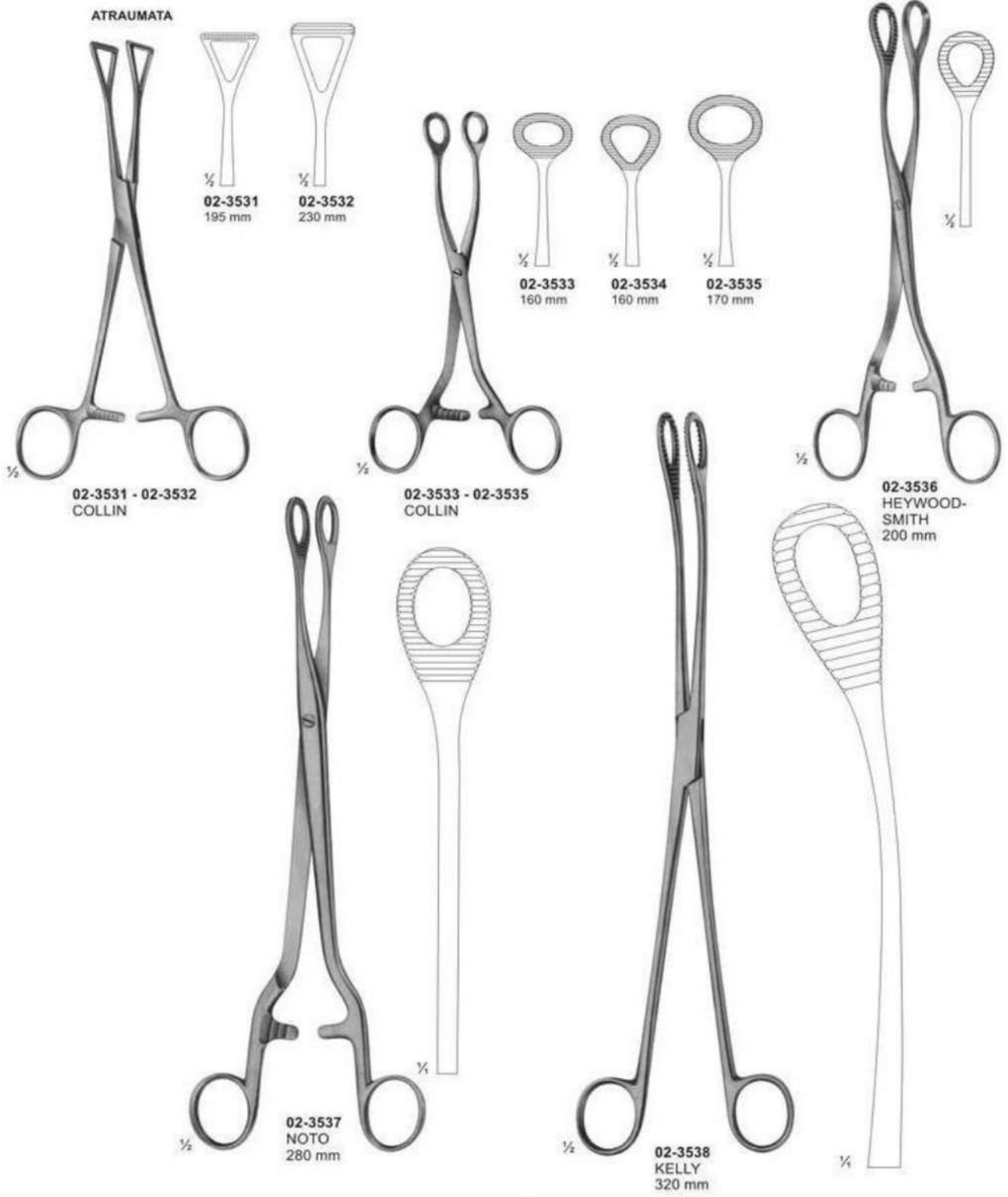



02-3539

02-3540

1/2
02-3539 - 02-3540
HERZ
155 mm



02-3541

1/2
02-3541
JACKSON
4 x 5 teeth
150 mm

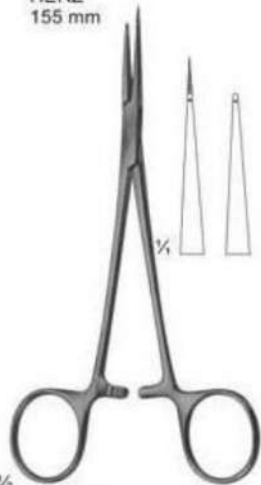

1/2
02-3542
Tendon interlacing
forceps
150 mm



1/2
02-3543
Tendon interlacing
forceps
150 mm



1/2
02-3544
Tendon seizing
forceps
120 mm

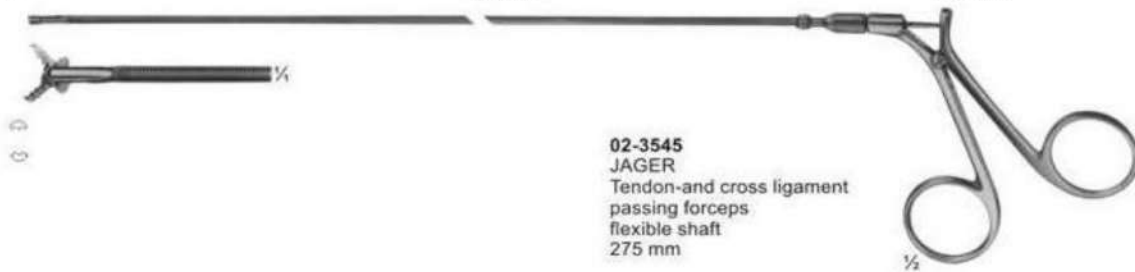

02-3545
JAGER
Tendon and cross ligament
passing forceps
flexible shaft
275 mm

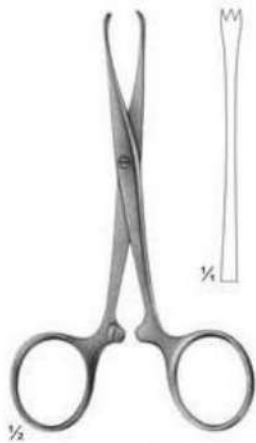

02-3546
CHAPUT
 2 x 3 teeth sharp
 125 mm

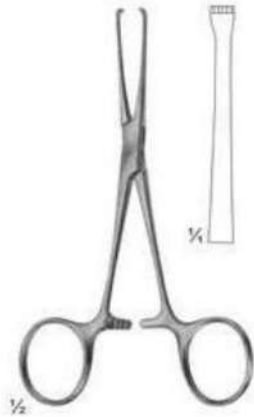

02-3547
BABY-ALLIS
 4 x 5 teeth
 130 mm



02-3548
BOYS-ALLIS
 5 x 6 teeth sharp
 155 mm

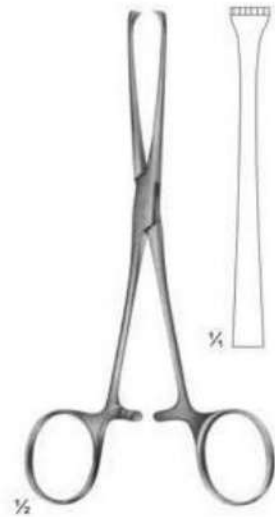

02-3549
ALLIS
 5 x 6 teeth blunt
 155 mm



02-3550
LAHEY
 155 mm

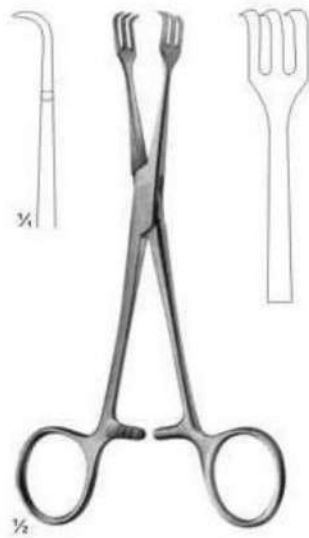

02-3551
LAHEY
 155 mm

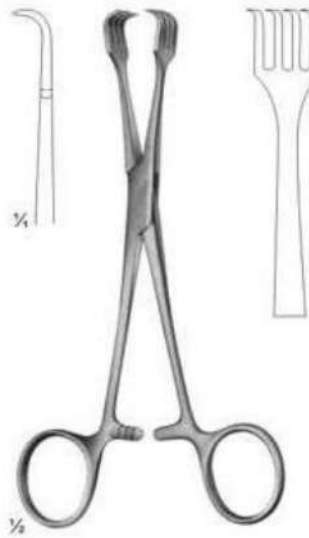

02-3552
BRAUN
 155 mm

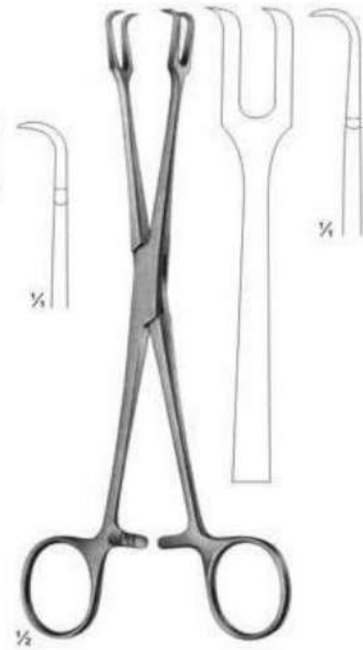

02-3553
MUSEUX
 200 mm

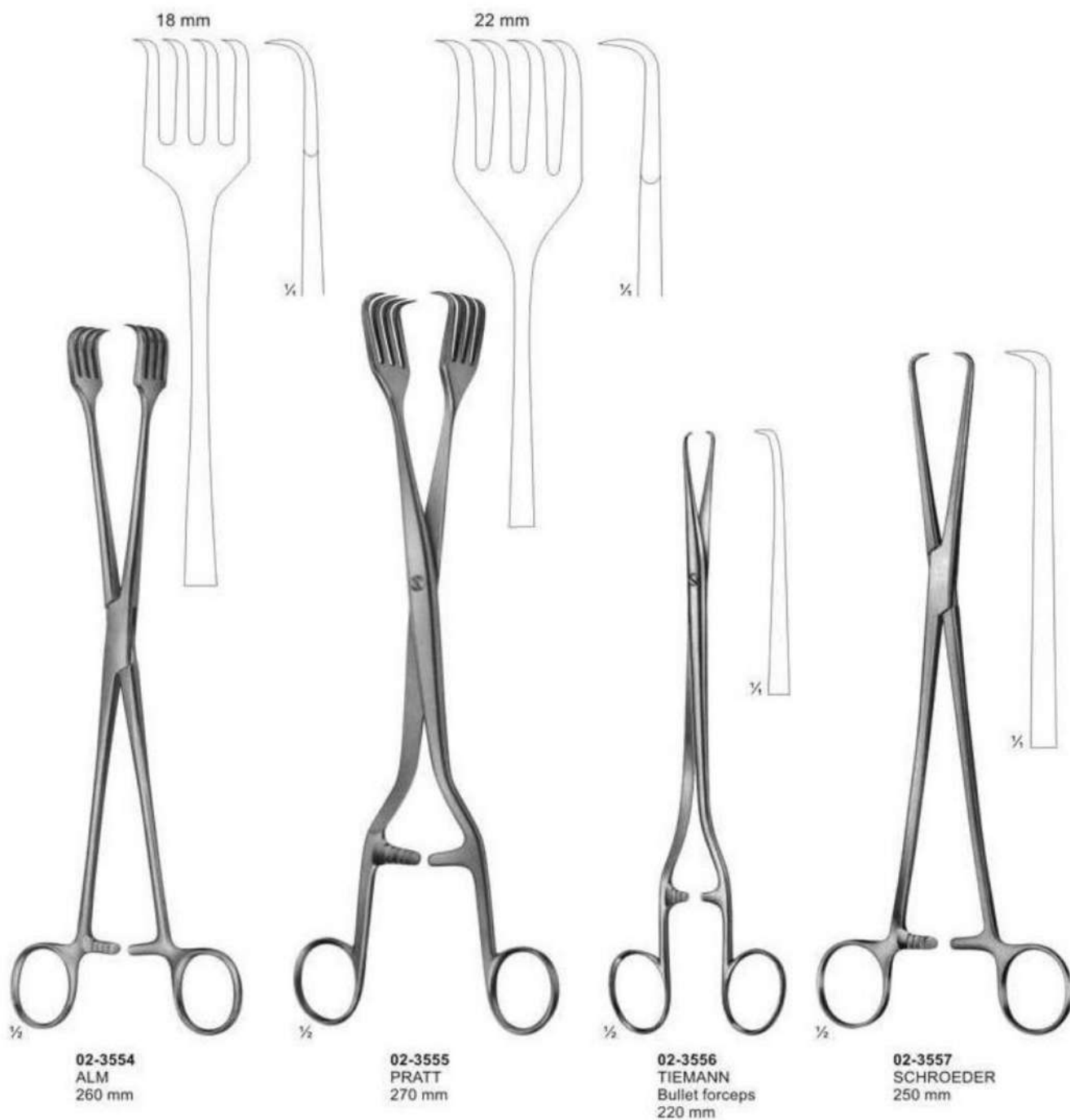

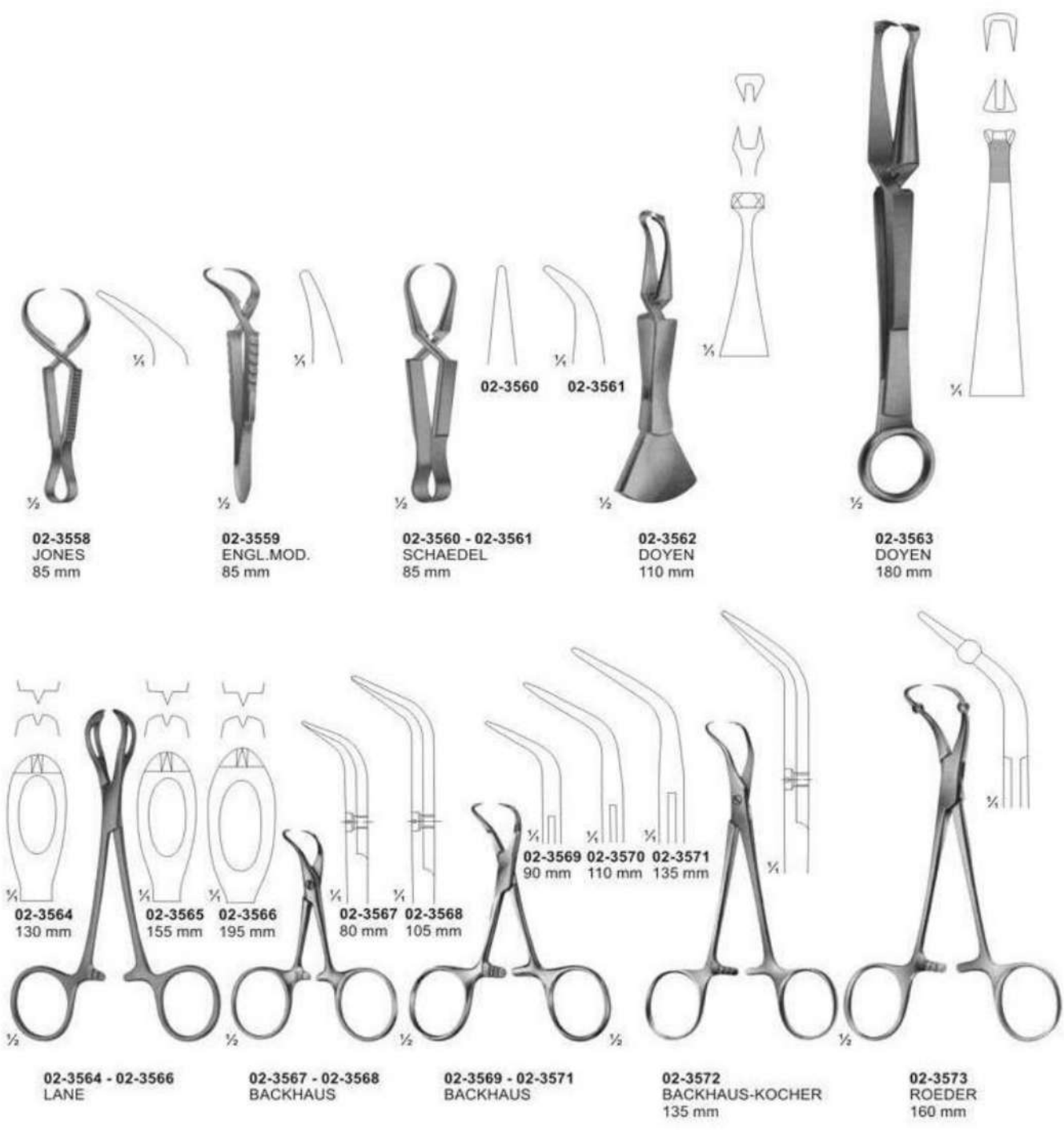



02-3574
ROBIN
with holders for tubing
up to 13 mm
135 mm



02-3575
with clip for tubing
up to 15 mm
110 mm



02-3576
LORNA
non perforating
130 mm



02-3577
for paper cloths
140 mm



02-3578
BUNT
105 mm



02-3579
MAYO
140 mm

Closing force

02-3580 Straight 50g	02-3581 80g	02-3582 Curved 50g	02-3583 80g	02-3584 Curved tips 50g	02-3585 80g
02-3586 Angled Shaped 50g	02-3587 80g	02-3588 Muller Knee-bent 50g	02-3589 80g	02-3590 Muller Ligature Forceps	Jaw, cross serrated Jaws profiles finally cross- serrated.

Non-traumatic vessel clips, temporary.

02-3591 38 mm 48 mm	02-3592 38 mm 48 mm	02-3593 58 mm	02-3594 58 mm	02-3595 - 02-3601	02-3602 DE BAKEY- HESS Length of Jaws 20 mm

02-3595 38 mm
02-3596 48 mm
02-3597 56 mm
02-3598 63 mm
02-3599 70 mm
02-3600 80 mm
02-3601 91 mm

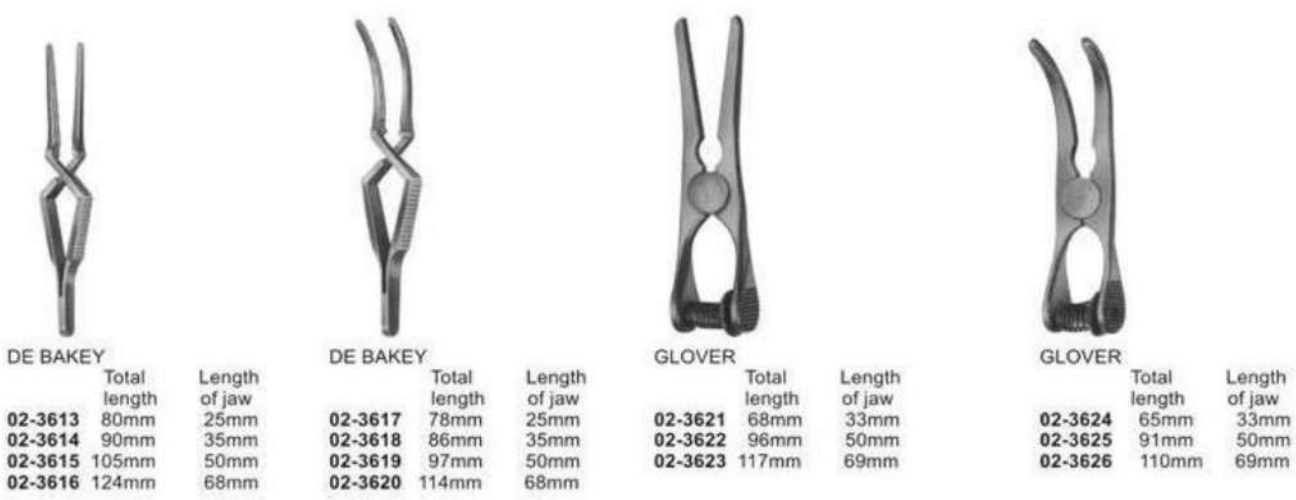
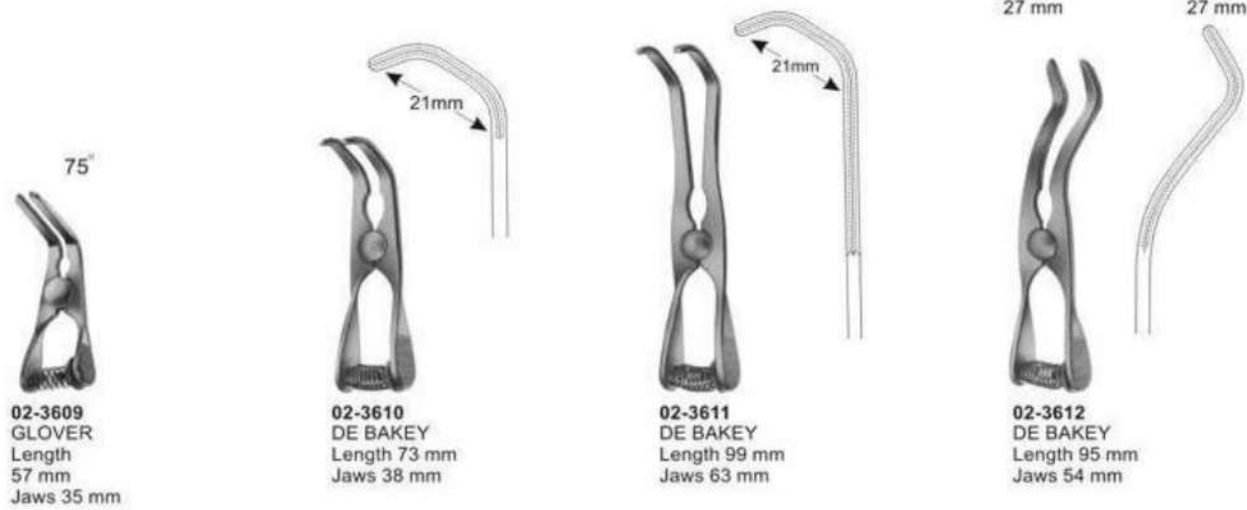

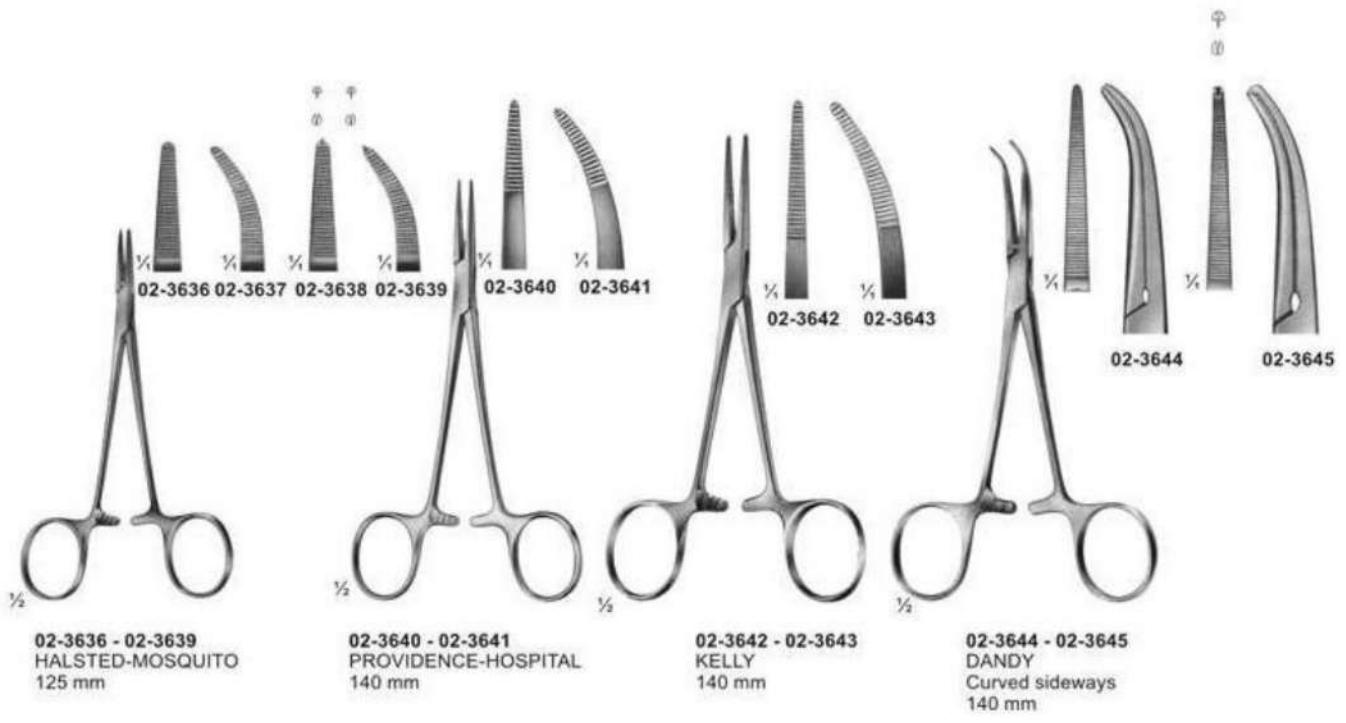
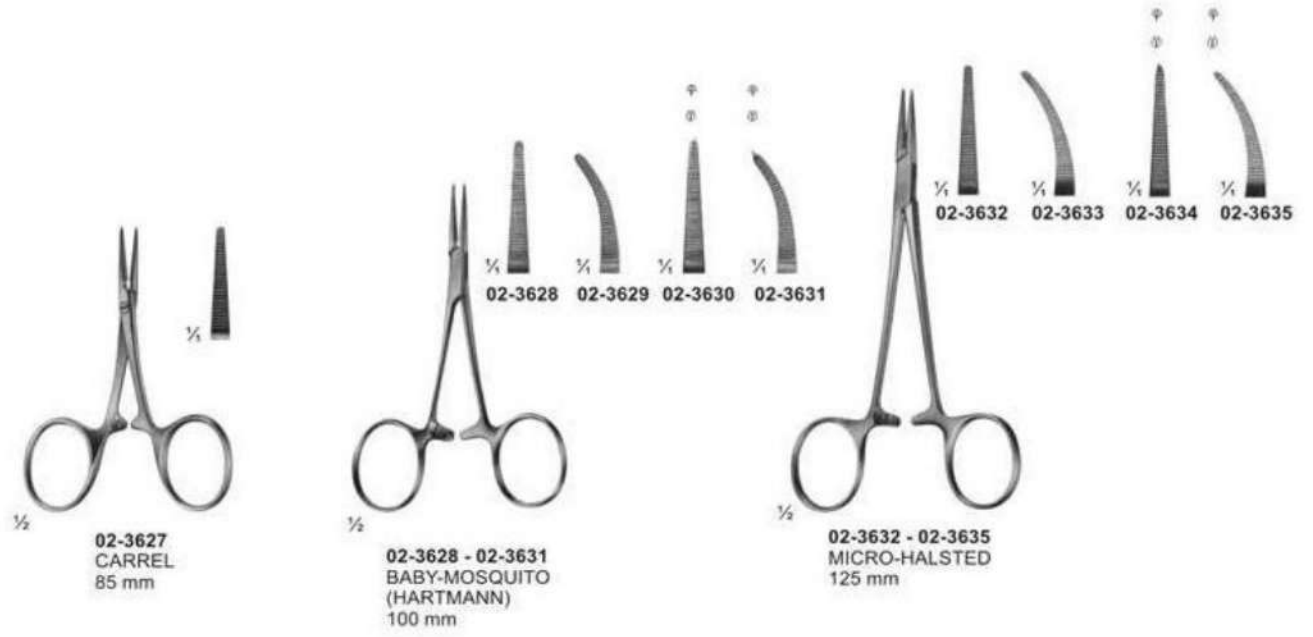

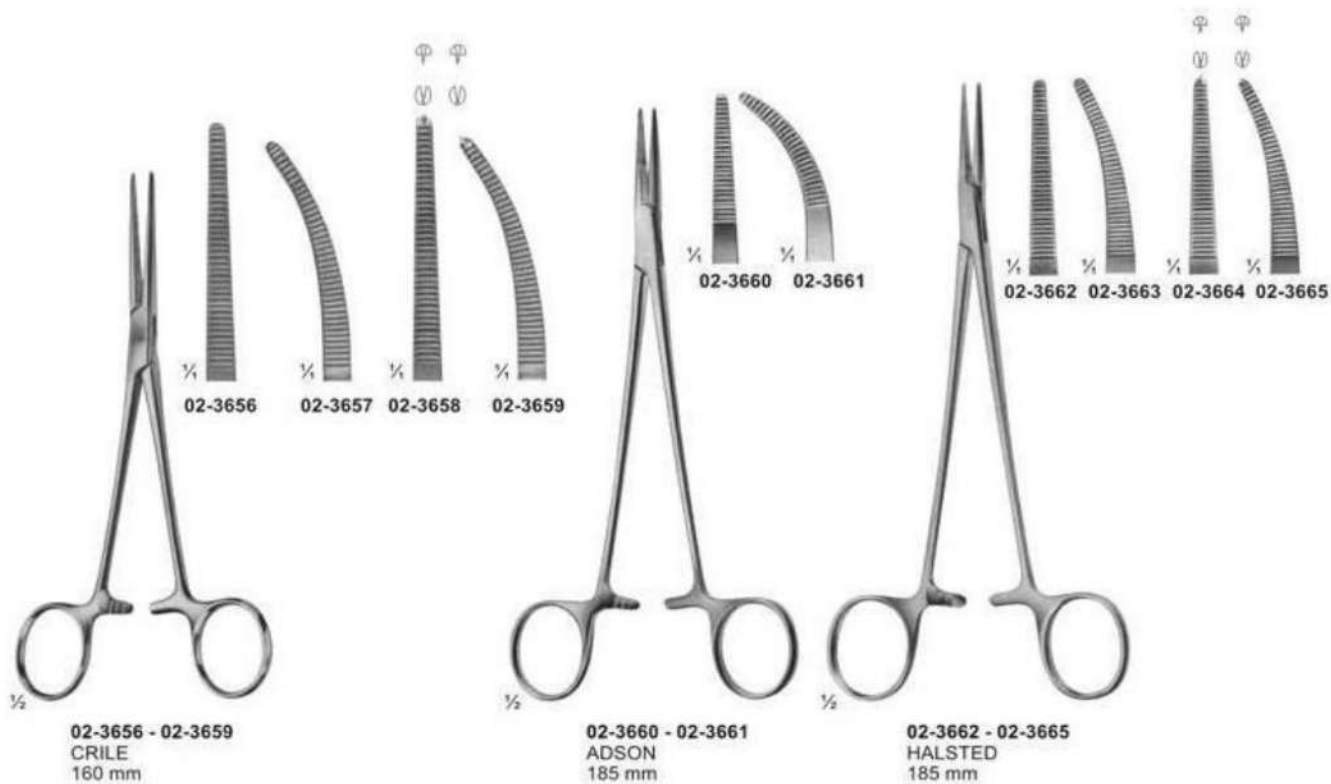
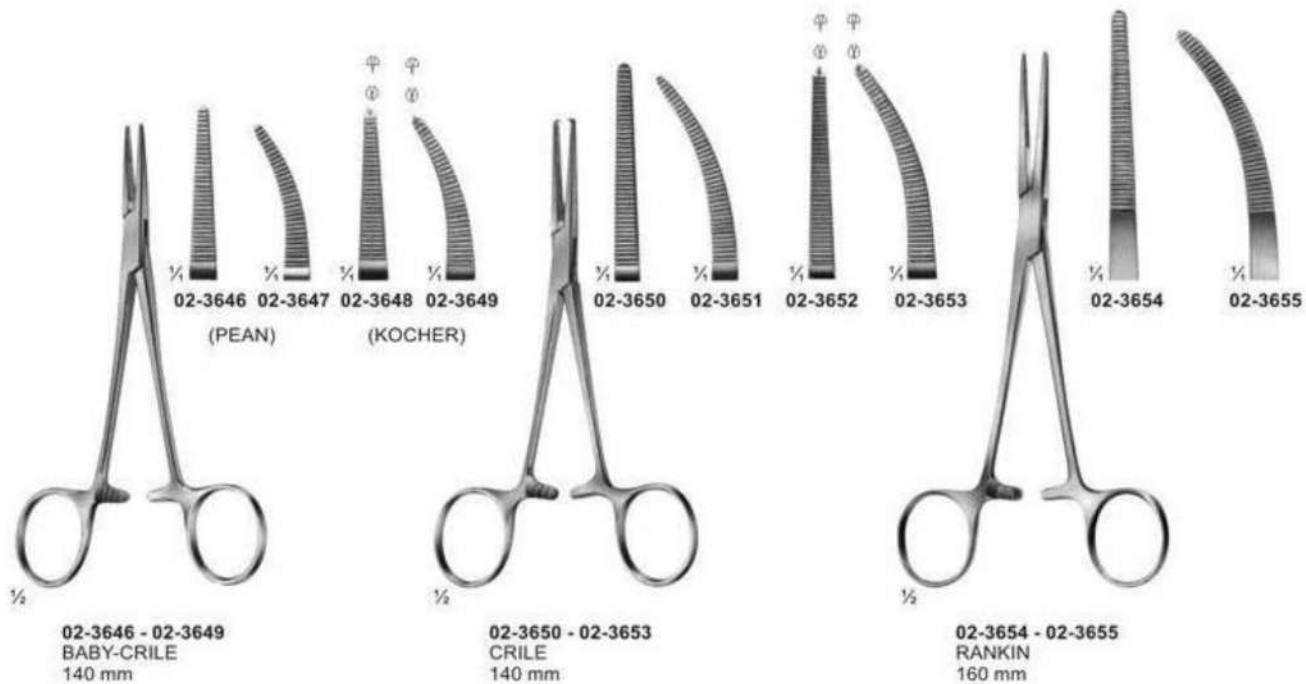

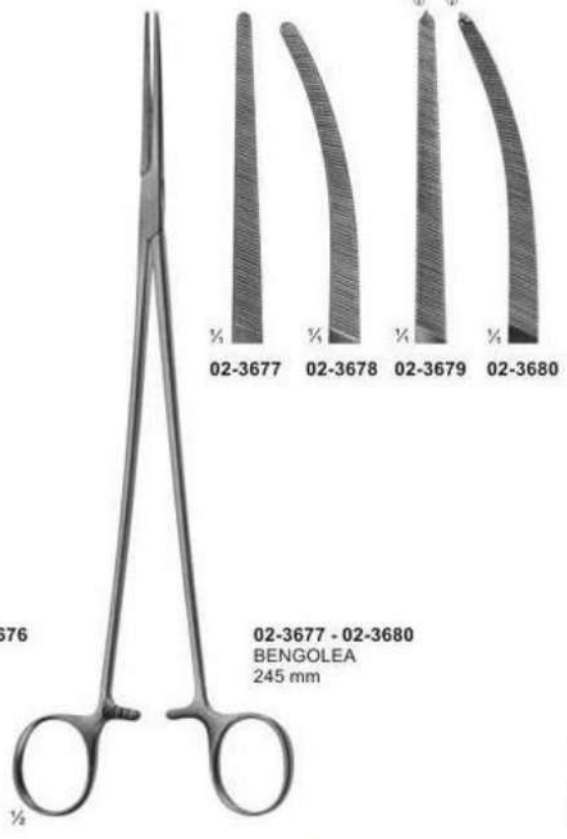
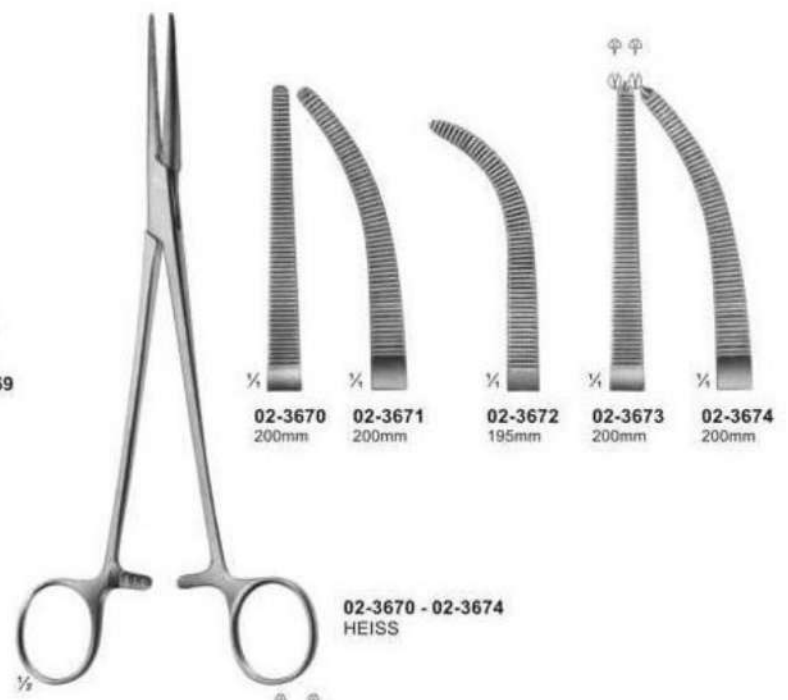

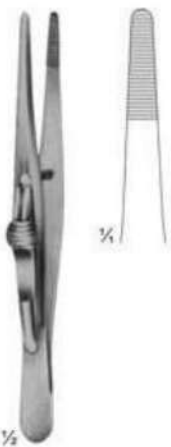

02-3682
FRICKE
Artery forceps.
130 mm



02-3683
KRONLEIN
130 mm



02-3684
PEAN
125 mm

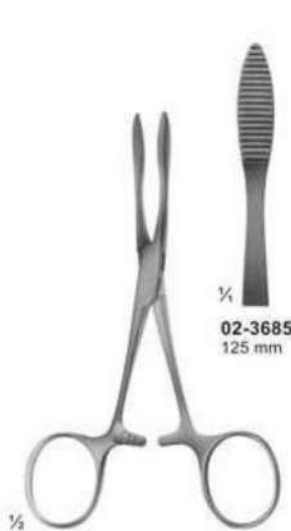

02-3685
125 mm



02-3686
140 mm



02-3687
PEAN
125mm



02-3688
165 mm



02-3689
185 mm

02-3688 - 02-3689
PEAN

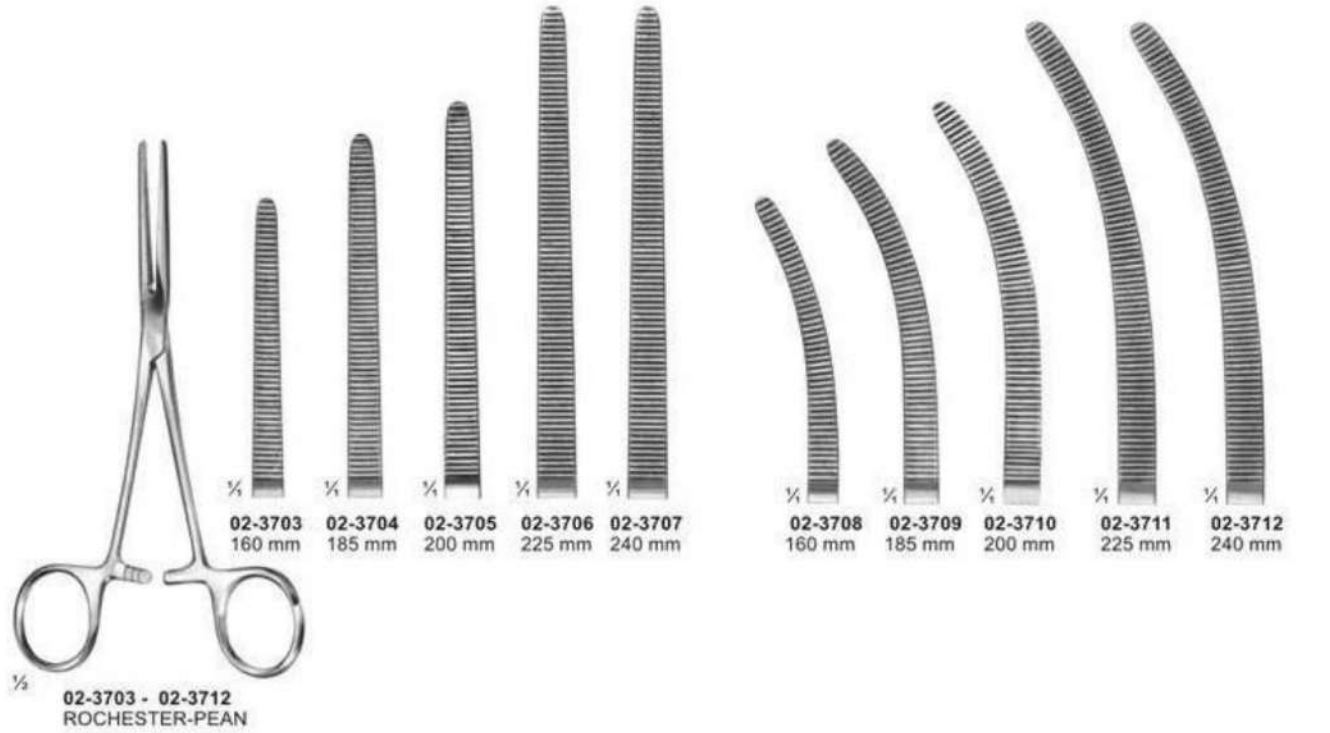

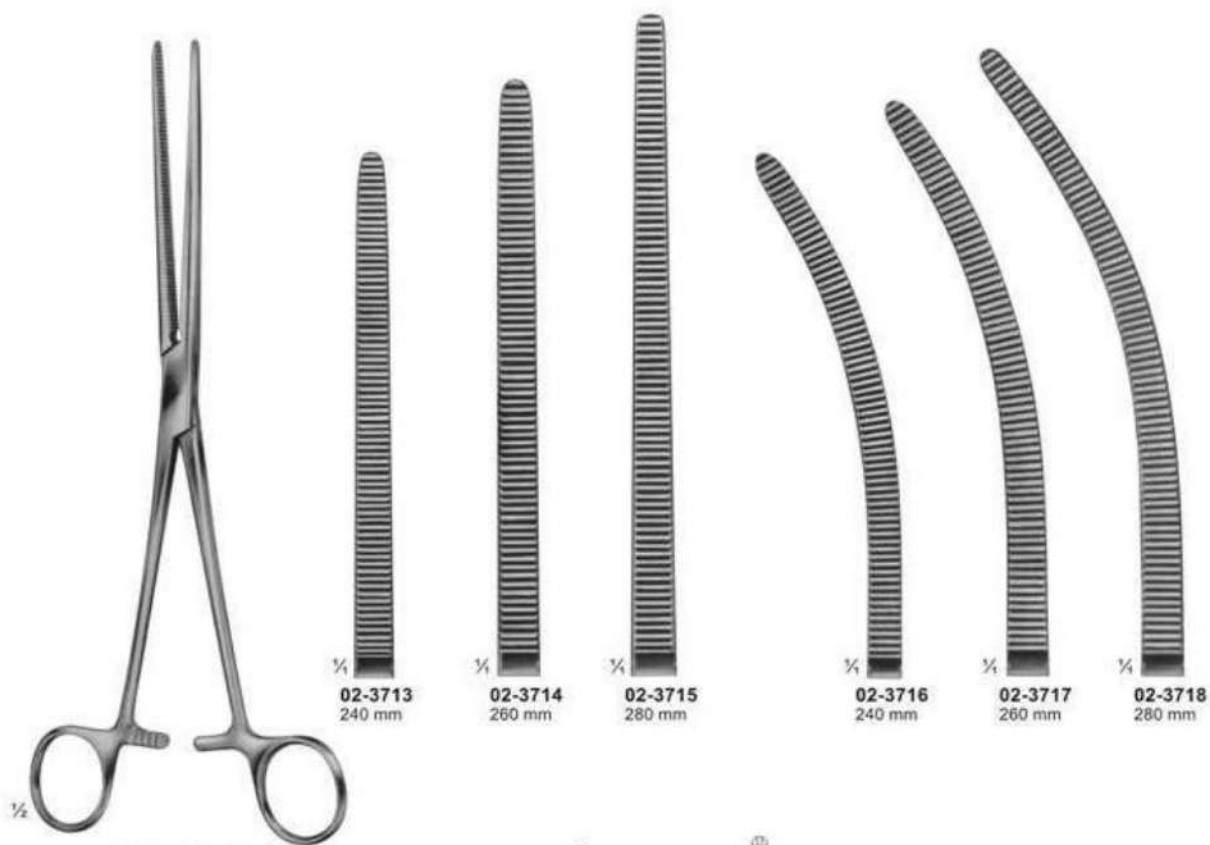

02-3713 - 02-3718
PEAN

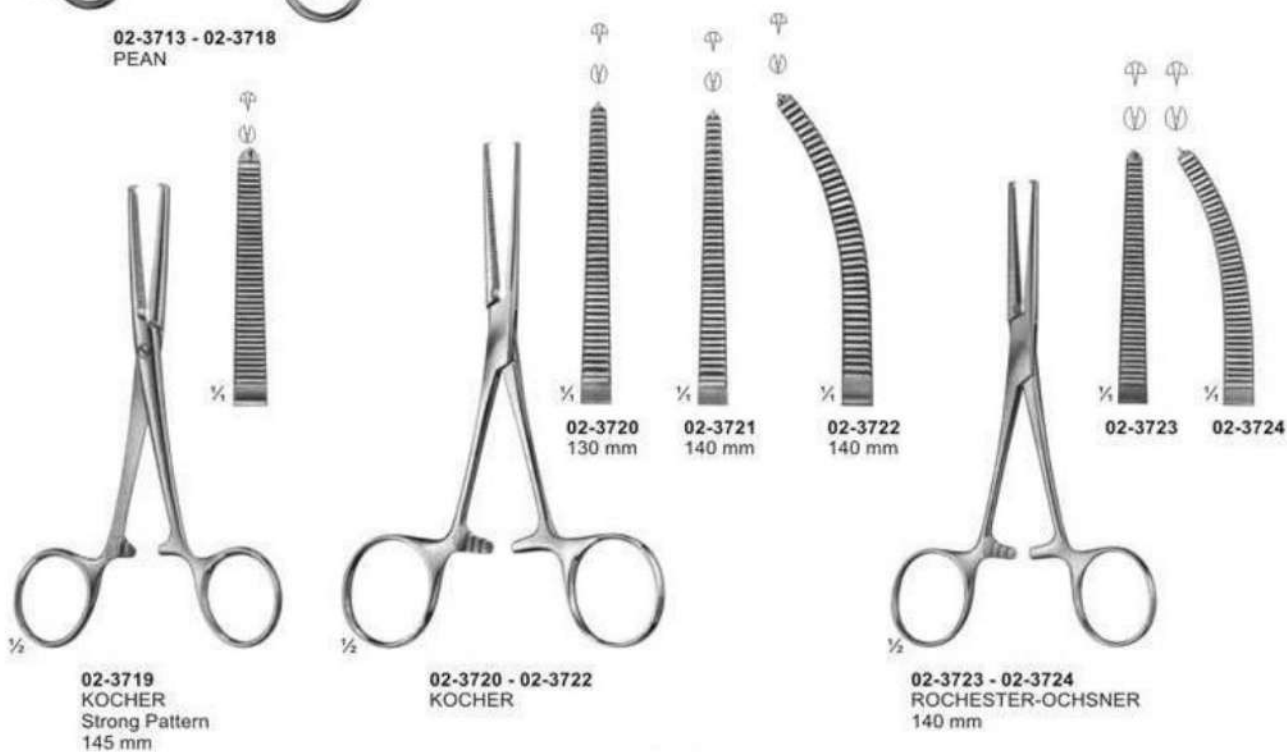

02-3719
KOCHER
Strong Pattern
145 mm

02-3720 - 02-3722
KOCHER

02-3723 - 02-3724
ROCHESTER-OCHSNER
140 mm

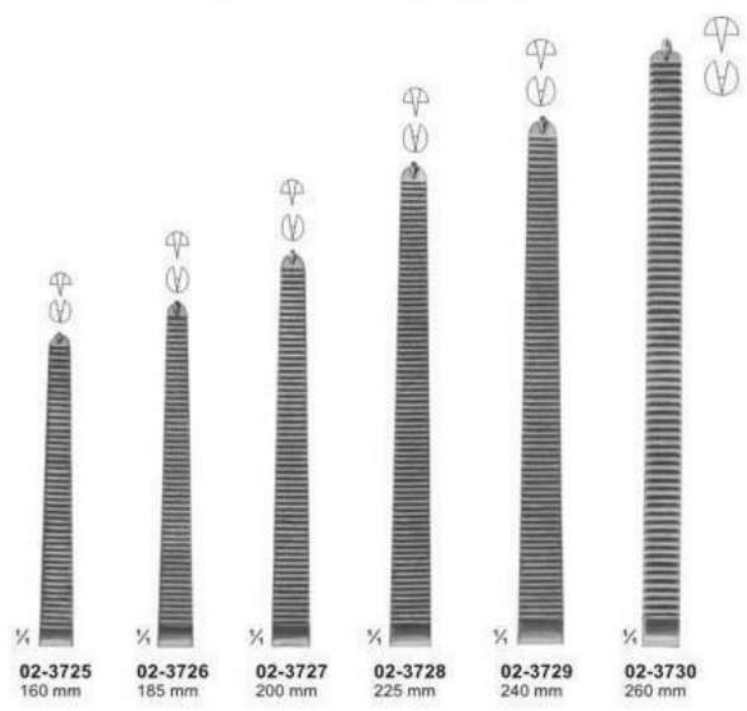

02-3725 - 02-3736
KOCHER-OCHSNER

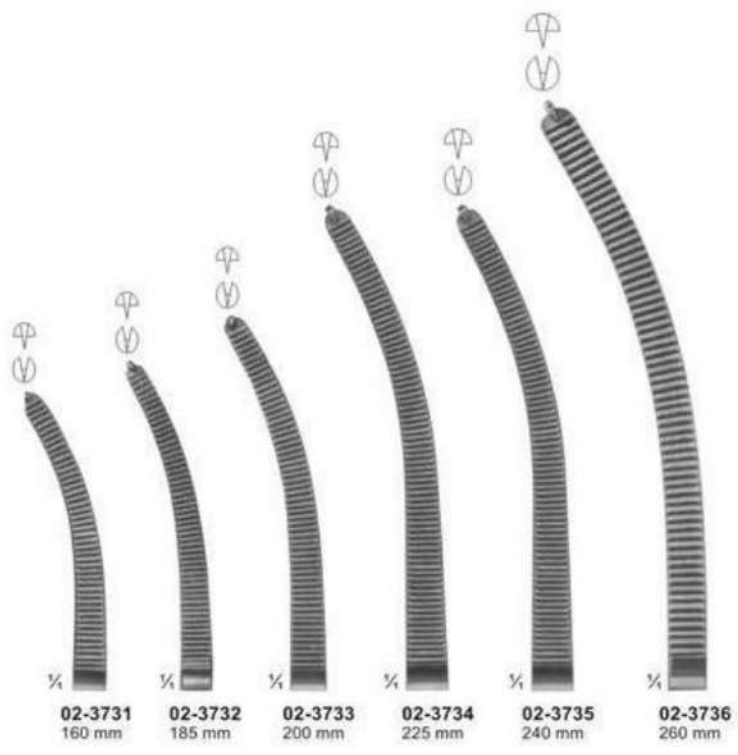

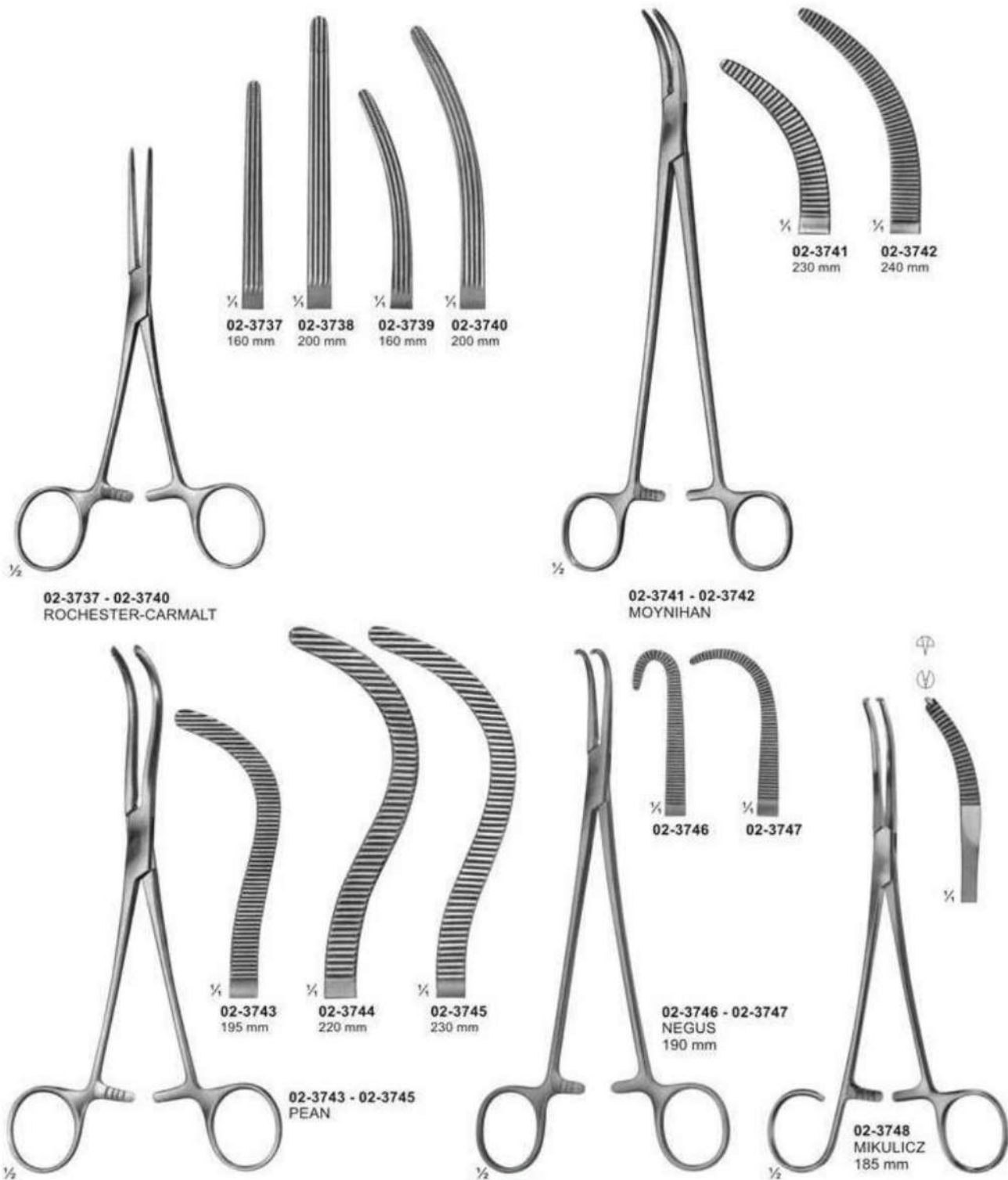



02-3749
MICRO-ADSON
140 mm



02-3750
BABY-OVERHOLT
135 mm



02-3751 - 02-3752
BABY-MIXTER

02-3751
140 mm

02-3752
180 mm

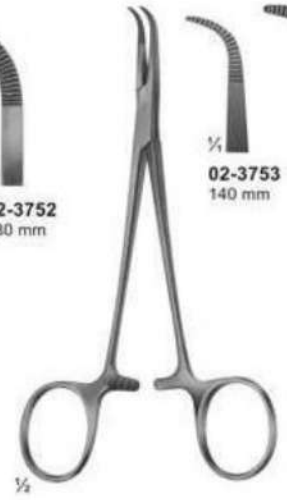

02-3753 - 02-3754
BABY-ADSON

02-3753
140 mm

02-3754
180 mm



02-3755
NISSEN

02-3755
185 mm



02-3756 - 02-3757
YASARGIL
195 mm

02-3756

02-3757



02-3758
OVERHOLT-MIXTER

02-3758
205 mm



1/2

02-3759 - 02-3770
OVERHOLT-GEISSENDOERFER

Fig. 0	1	2	3	4	5	6
02-3759	02-3760	02-3761	02-3762	02-3763	02-3764	02-3765
195 mm	210 mm	220 mm	225 mm	210 mm	230 mm	225 mm
	02-3766	02-3767	02-3768	02-3769	02-3770	
	260 mm	270 mm	275 mm	270 mm	280 mm	



1/2

02-3771 - 02-3778
OVERHOLT
fine pattern

Fig. 0	1	2	3	6	0	1	6
02-3771	02-3772	02-3773	02-3774	02-3775	02-3776	02-3777	02-3778
215 mm	210 mm	220 mm	225 mm	225 mm	295 mm	295 mm	300 mm

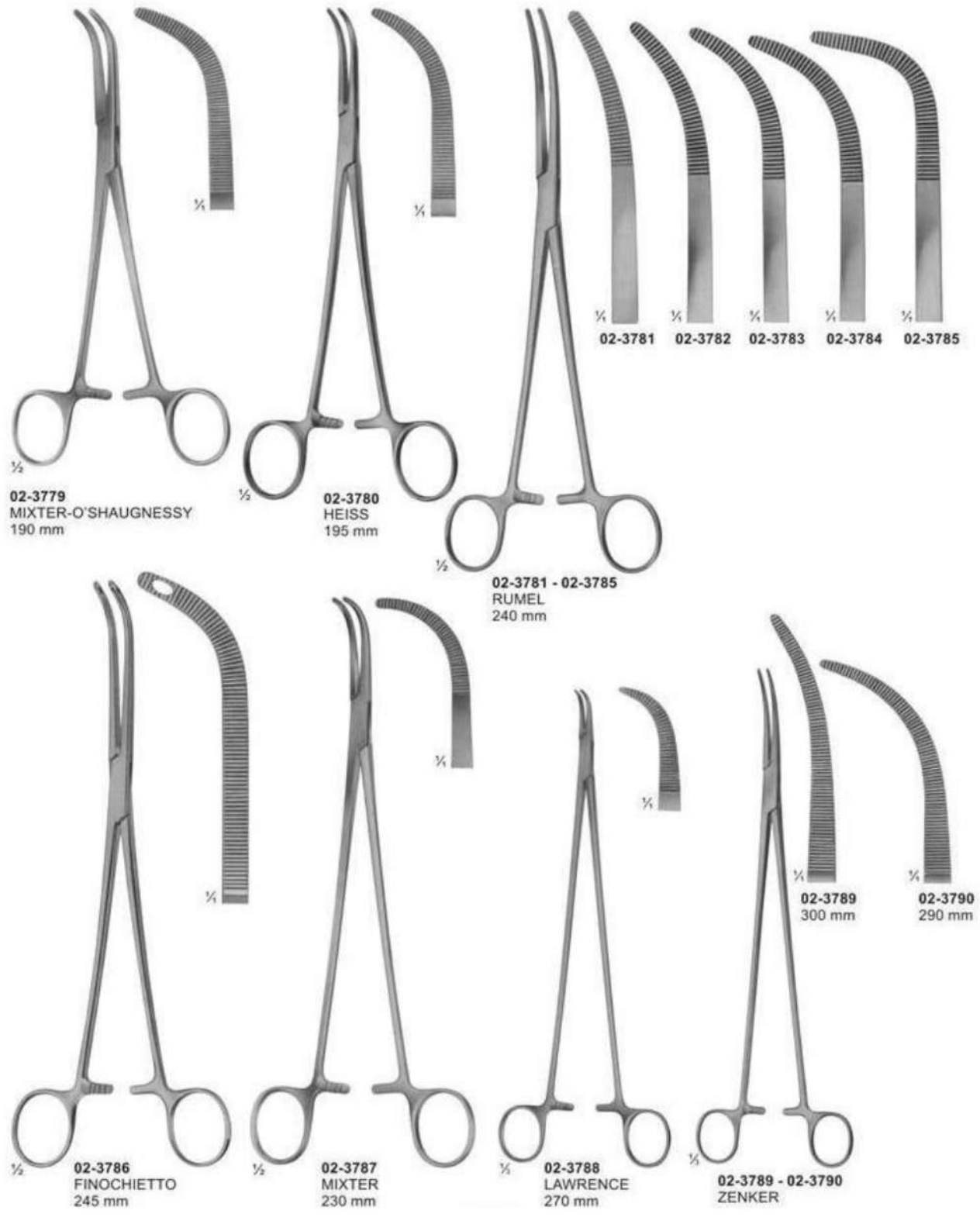





02-3799
BABY-MIKULICZ
140 mm



02-3800
MIKULICZ
185 mm

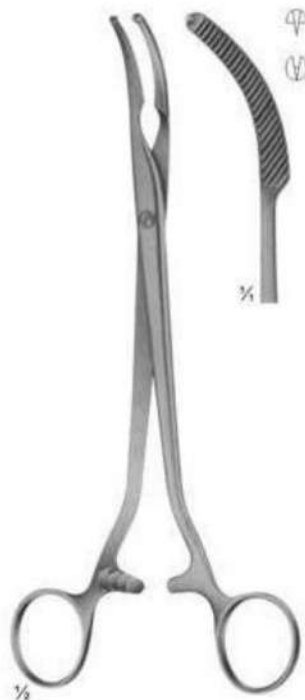

02-3801
MIKULICZ
205 mm



02-3802
MIKULICZ
200 mm



02-3803
MIKULICZ
205 mm



02-3804
MIKULICZ
185 mm



02-3805 - 02-3806
FAURE
205 mm

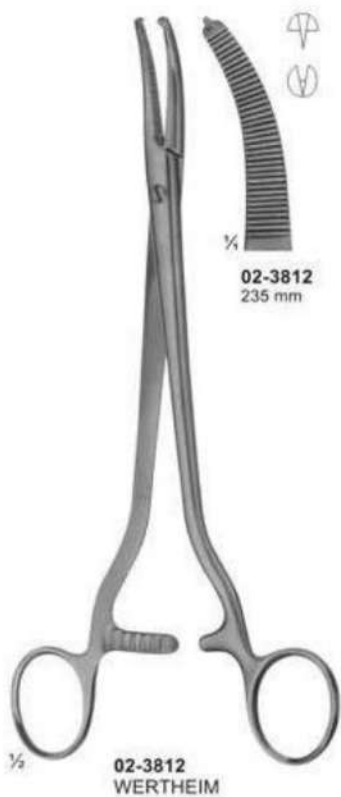
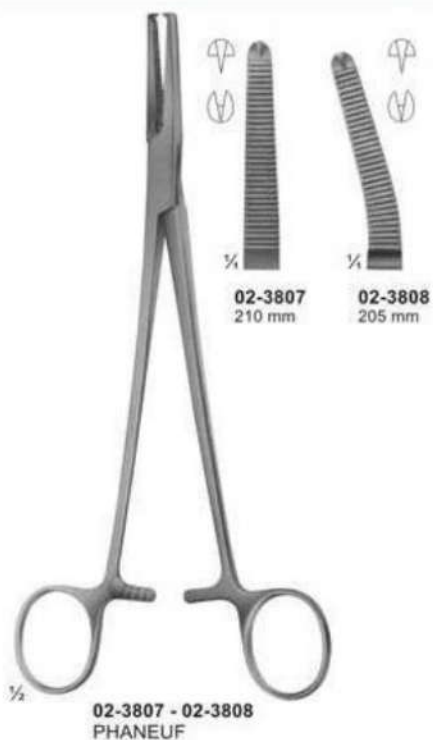

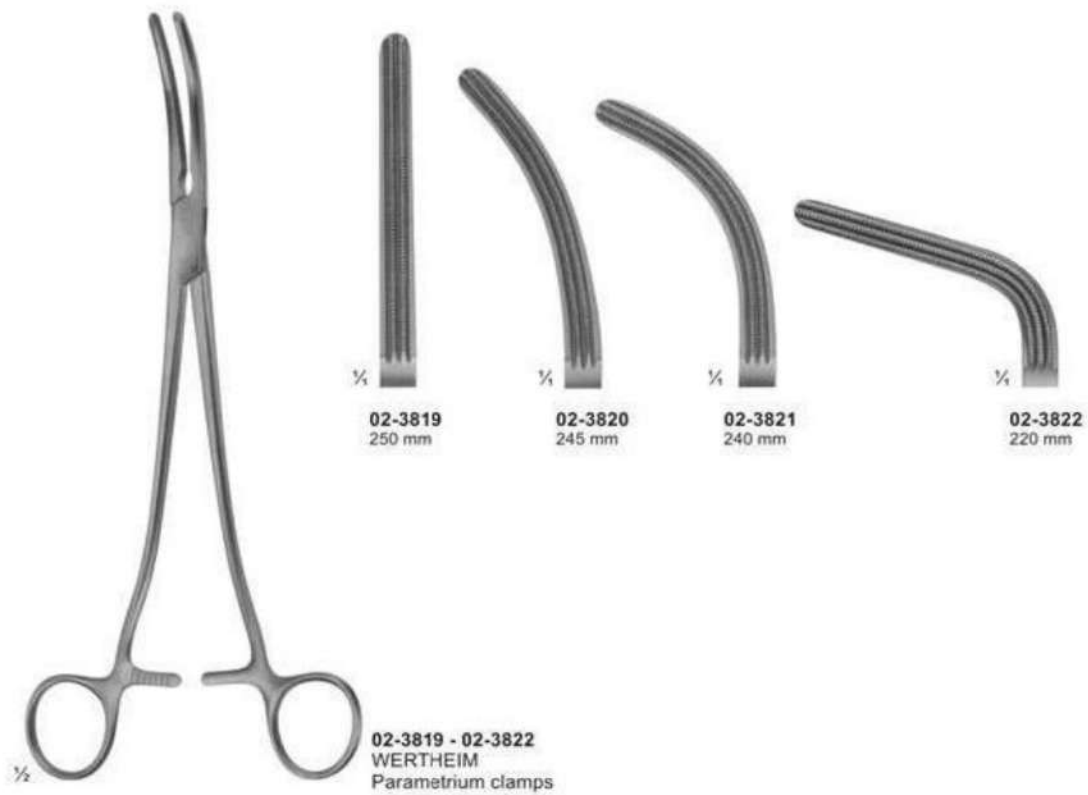
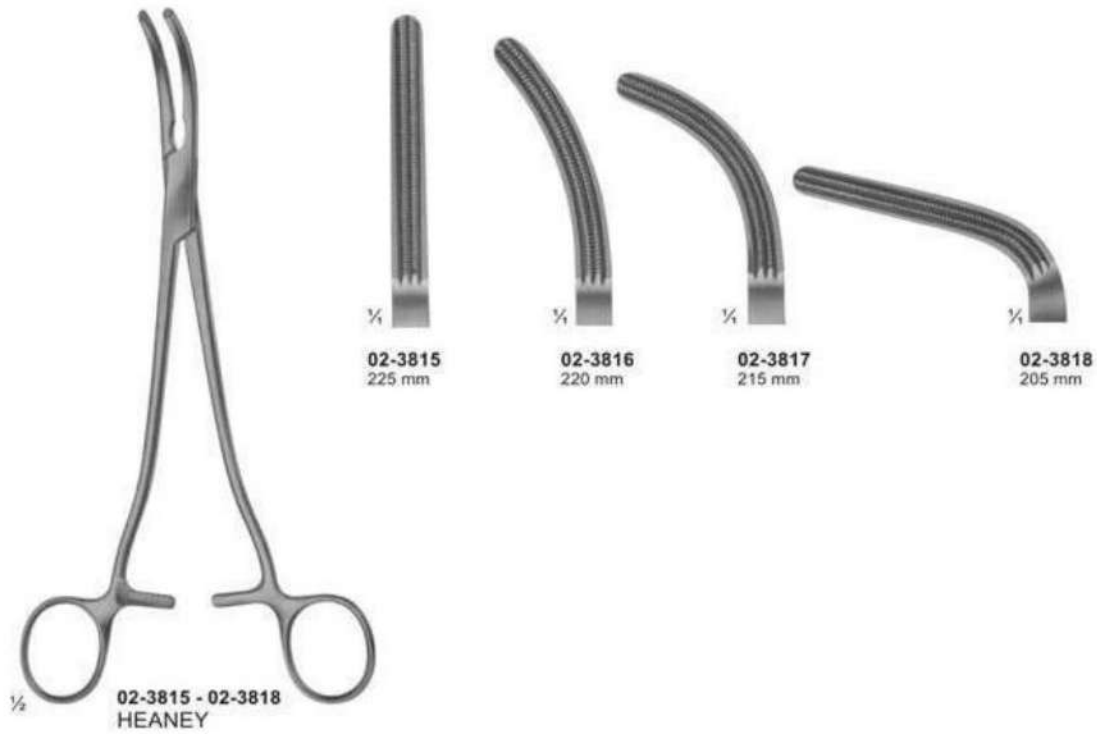

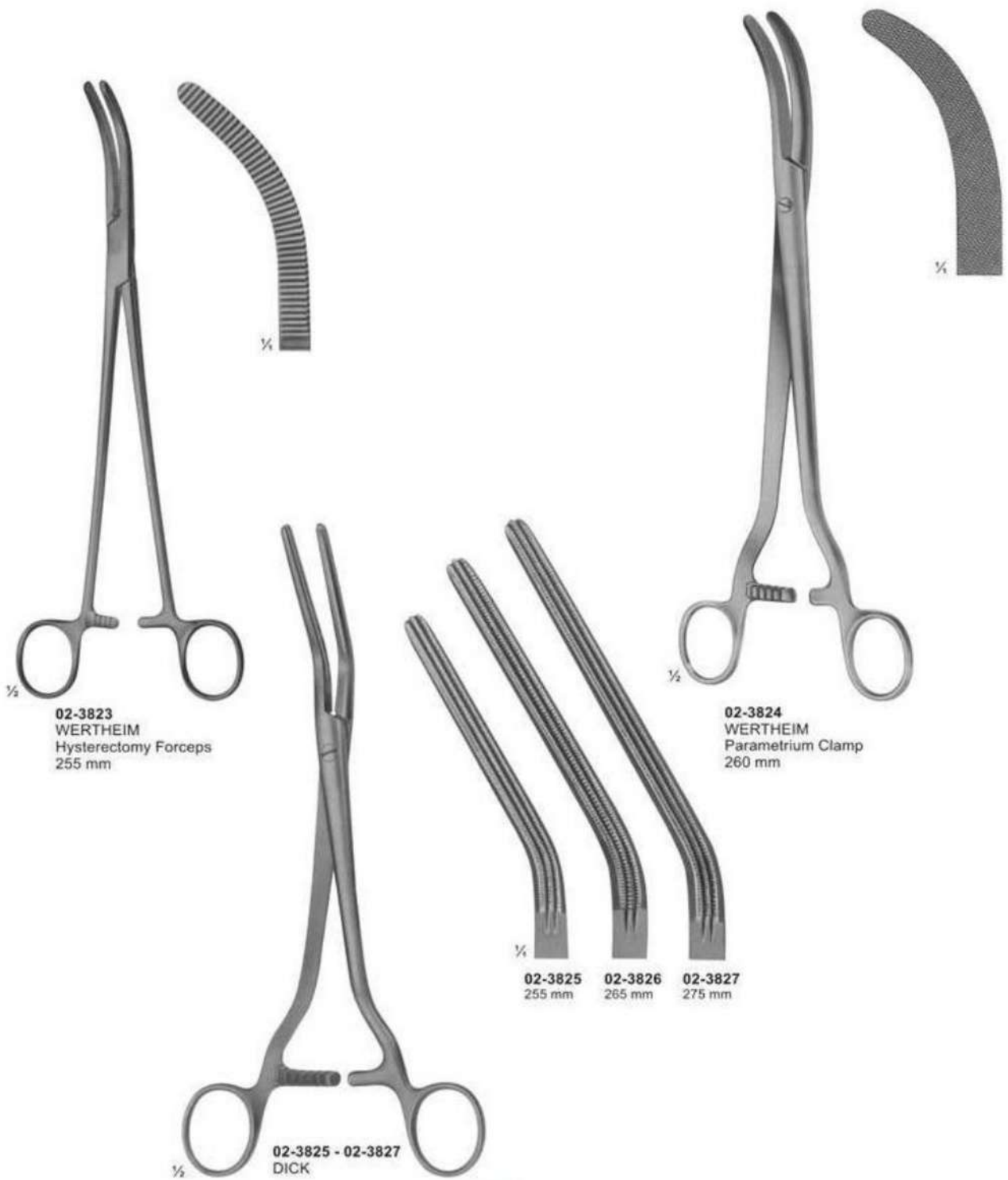

ATRAUMATA

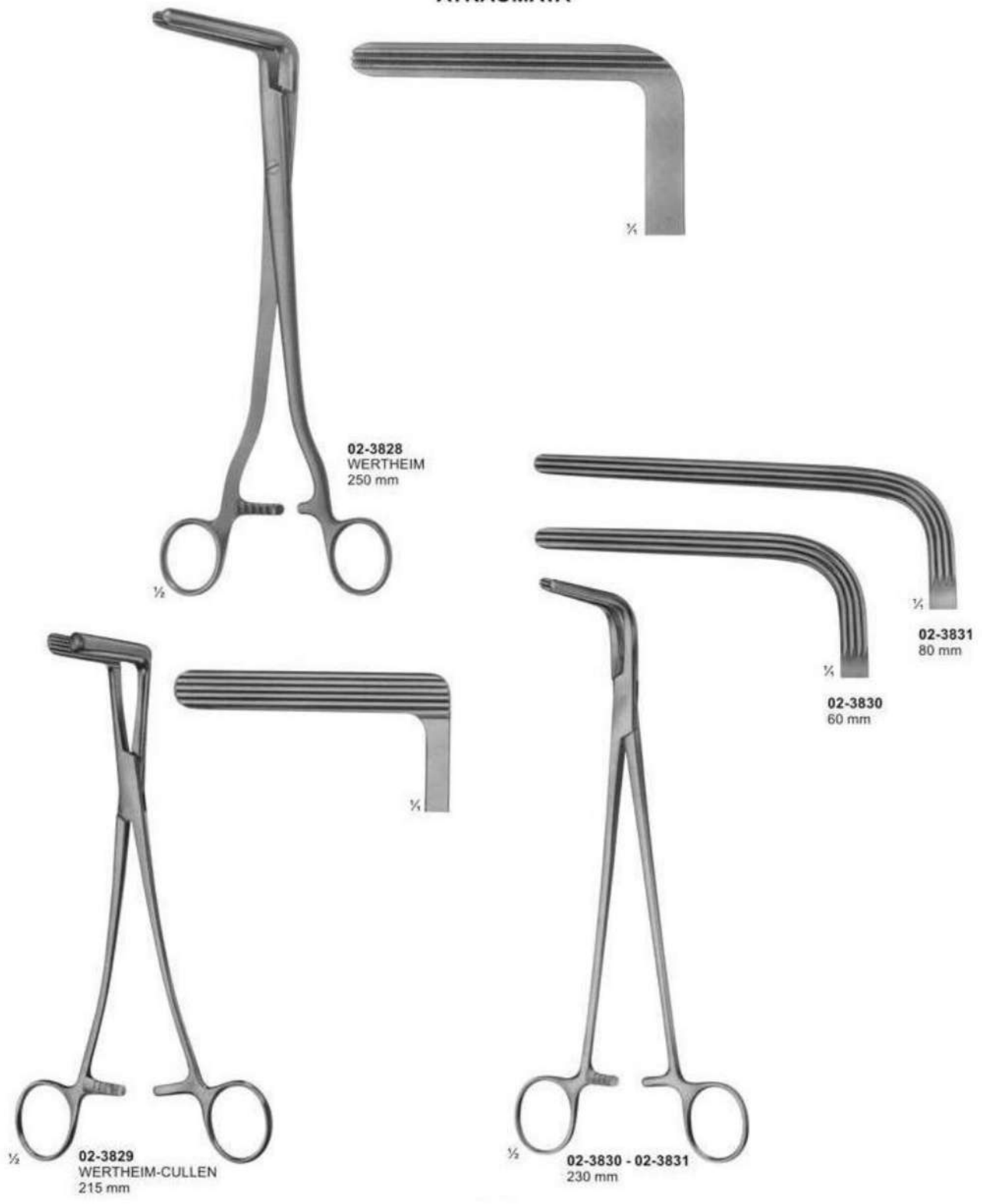

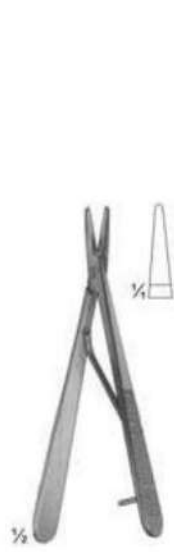

02-3832
ROHRSCHEIDER
With copper inserts
100 mm



02-3833
KALT
With catch
135 mm



02-3834
ARRUGA
With catch
135 mm



02-3835 - 02-3836
CASTROVIEJO
With catch
145 mm



02-3837 - 02-3838
CASTROVIEJO
With Catch
160 mm



02-3839 - 02-3840
Without catch
185 mm



02-3841 - 02-3842
JACOBSON
185 mm



02-3843
Without catch
195 mm



02-3844 - 02-3845
YASARGIL
With catch
200 mm

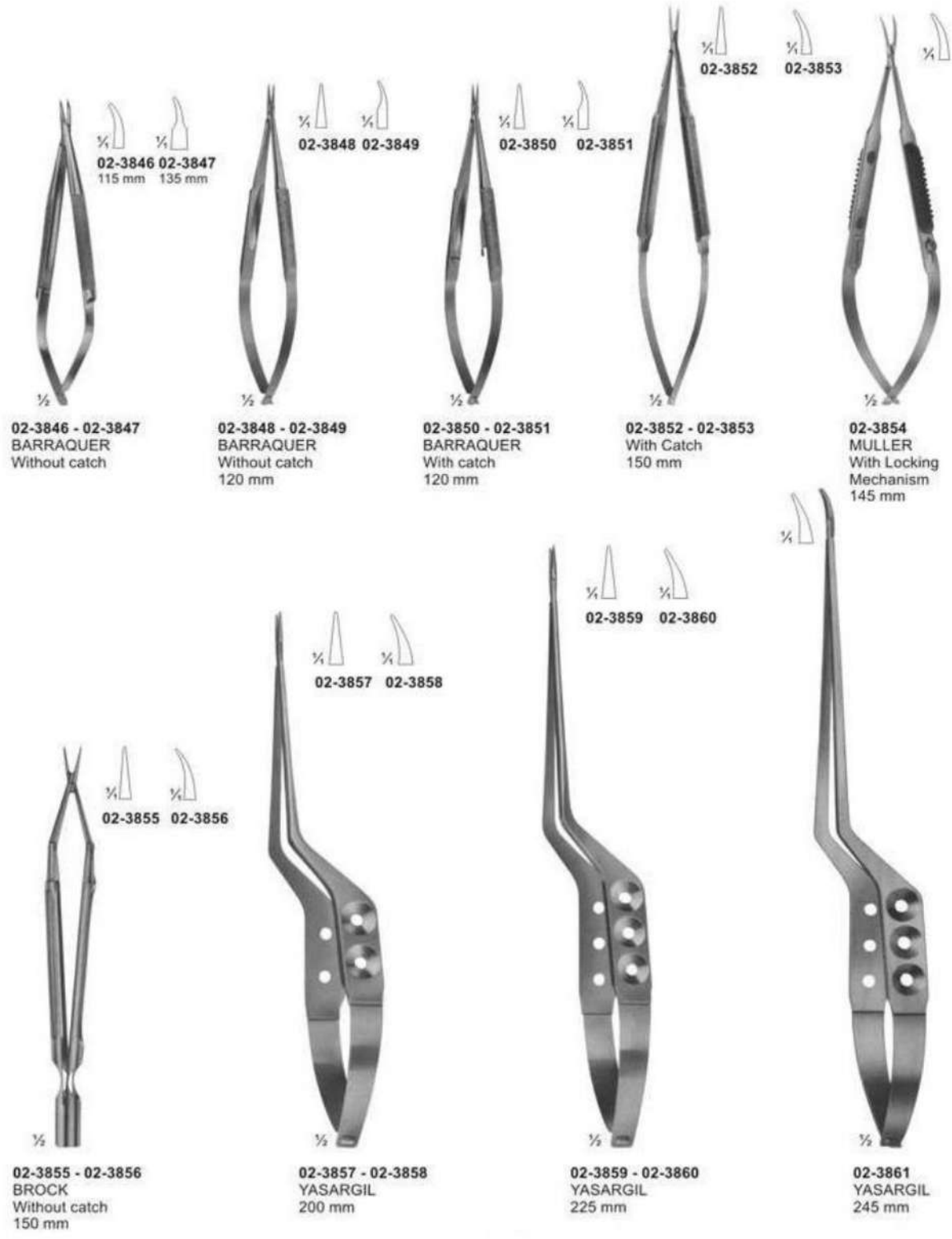

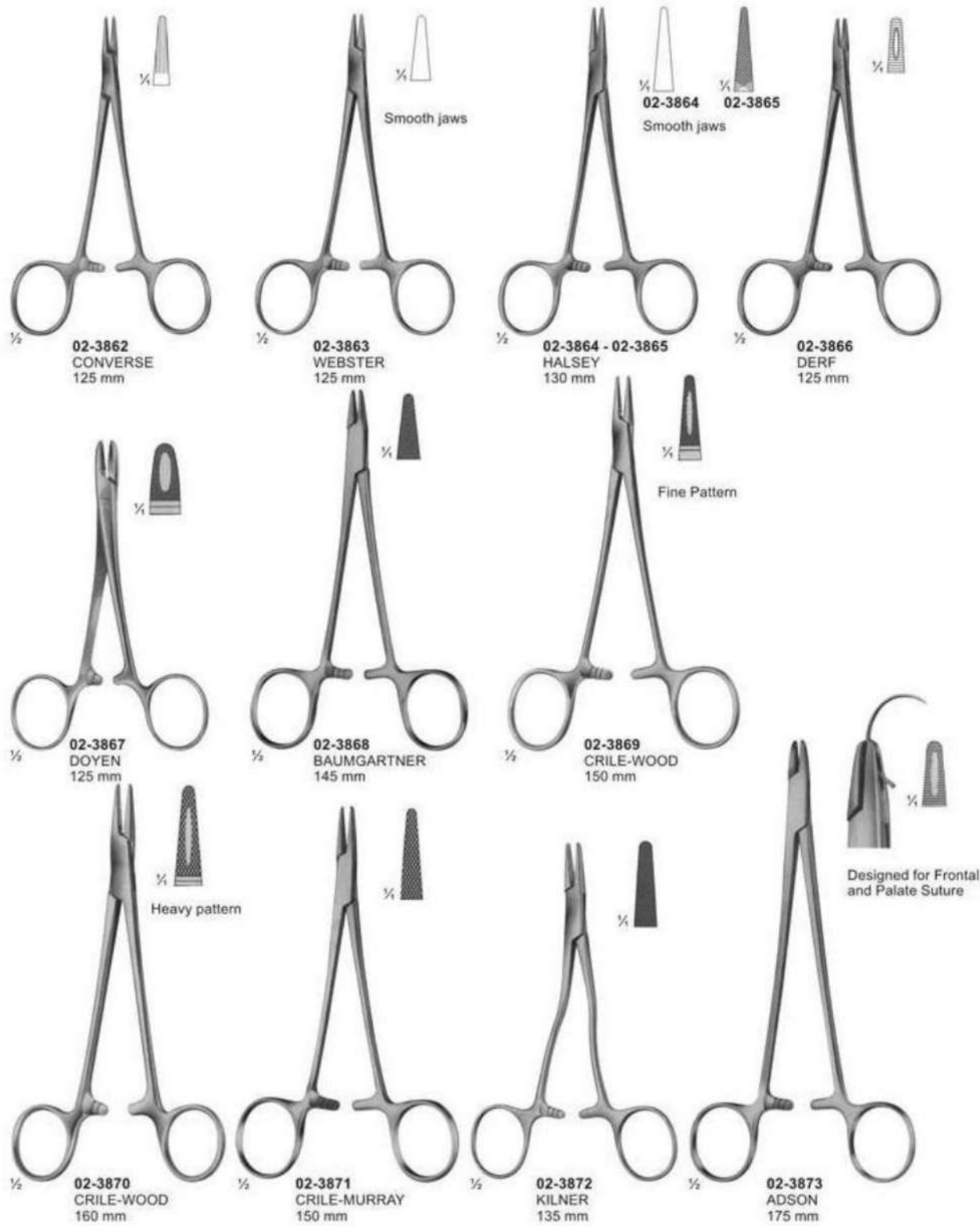



02-3874 - 02-3876
MAYO-HEGAR
Medium fine patterns

02-3877 - 02-3880
HEGAR
Heavy Patterns

02-3881
HEANEY (HEGAR)
200 mm



02-3882
JAMESON
230 mm

02-3883
WANGENSTEEN
275 mm

02-3884
MASSON
265 mm

02-3885
MASSON-LUETHY
255 mm

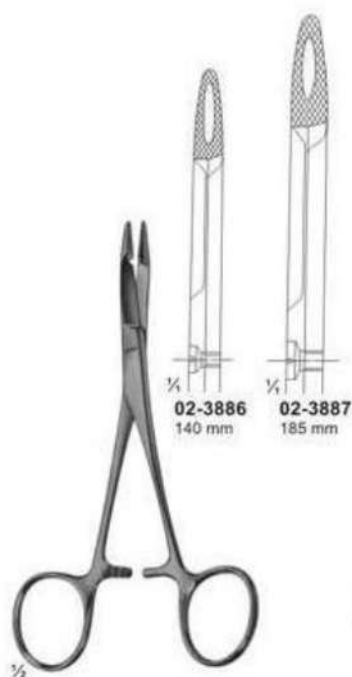

02-3886 - 02-3887
HEGAR-OLSEN
Needle Holders with Scissors

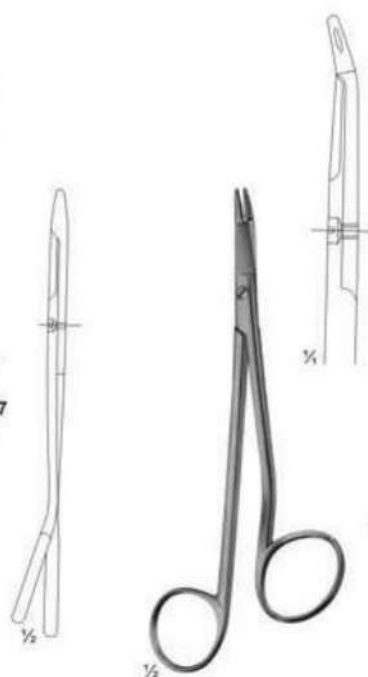

02-3888
GILLIES
Needle Holders with Scissors
150 mm



02-3889
GILLIES
Needle Holders with Scissors
160 mm

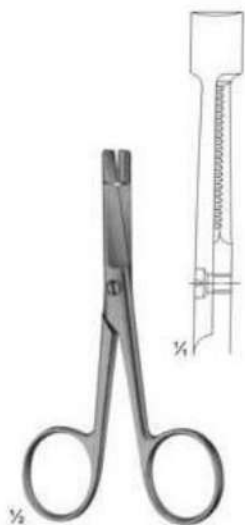

02-3890
EISELSBERG
Needle Holders with Scissors
115 mm

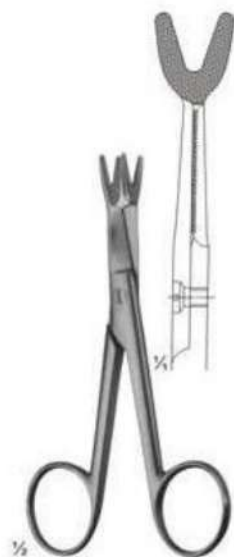

02-3891
SCHOEMAKER-LOTH
Needle Holders with Scissors
125 mm



02-3892
CRILE
150 mm



02-3893
TOENNIS
Elastic pattern for
dura-or intestinal suture
180 mm



Spare Needles

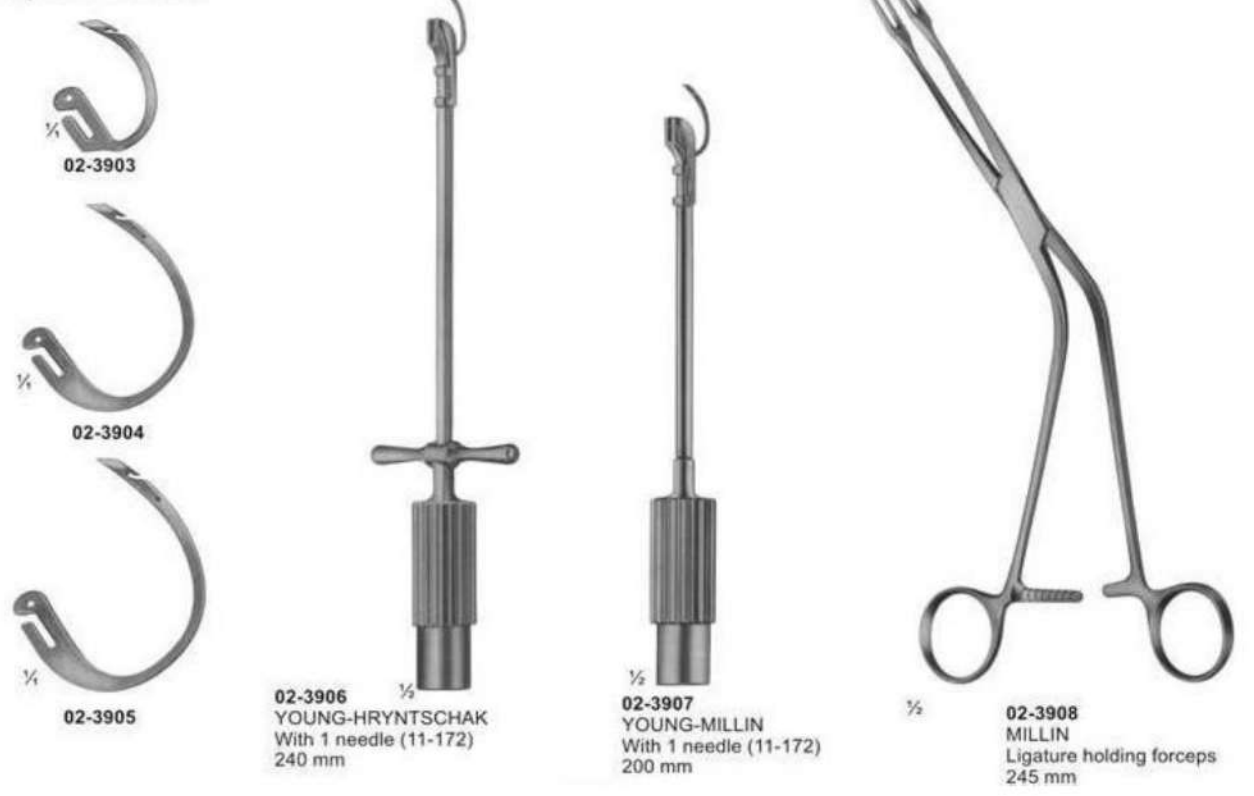



02-3909 - 02-3912
REVERDIN
140 mm

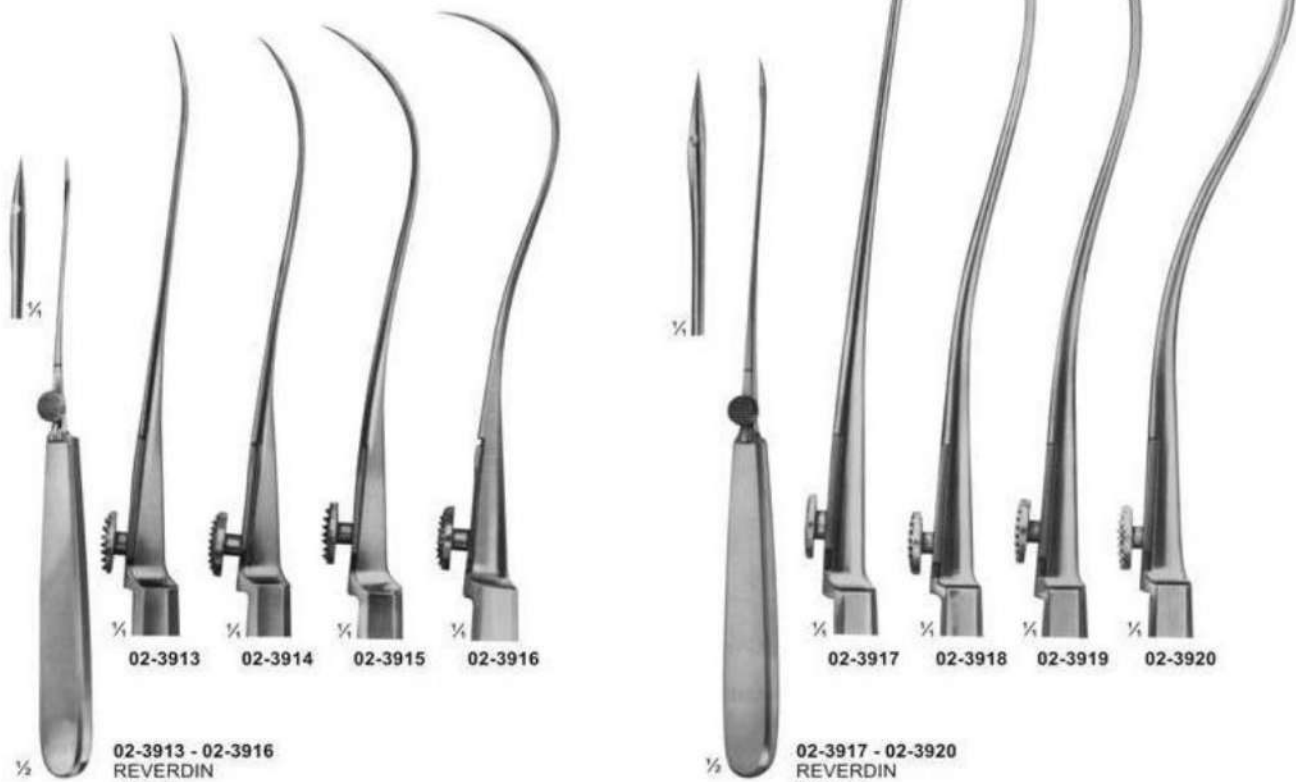

02-3913 - 02-3916
REVERDIN
195 mm

02-3917 - 02-3920
REVERDIN
220 mm

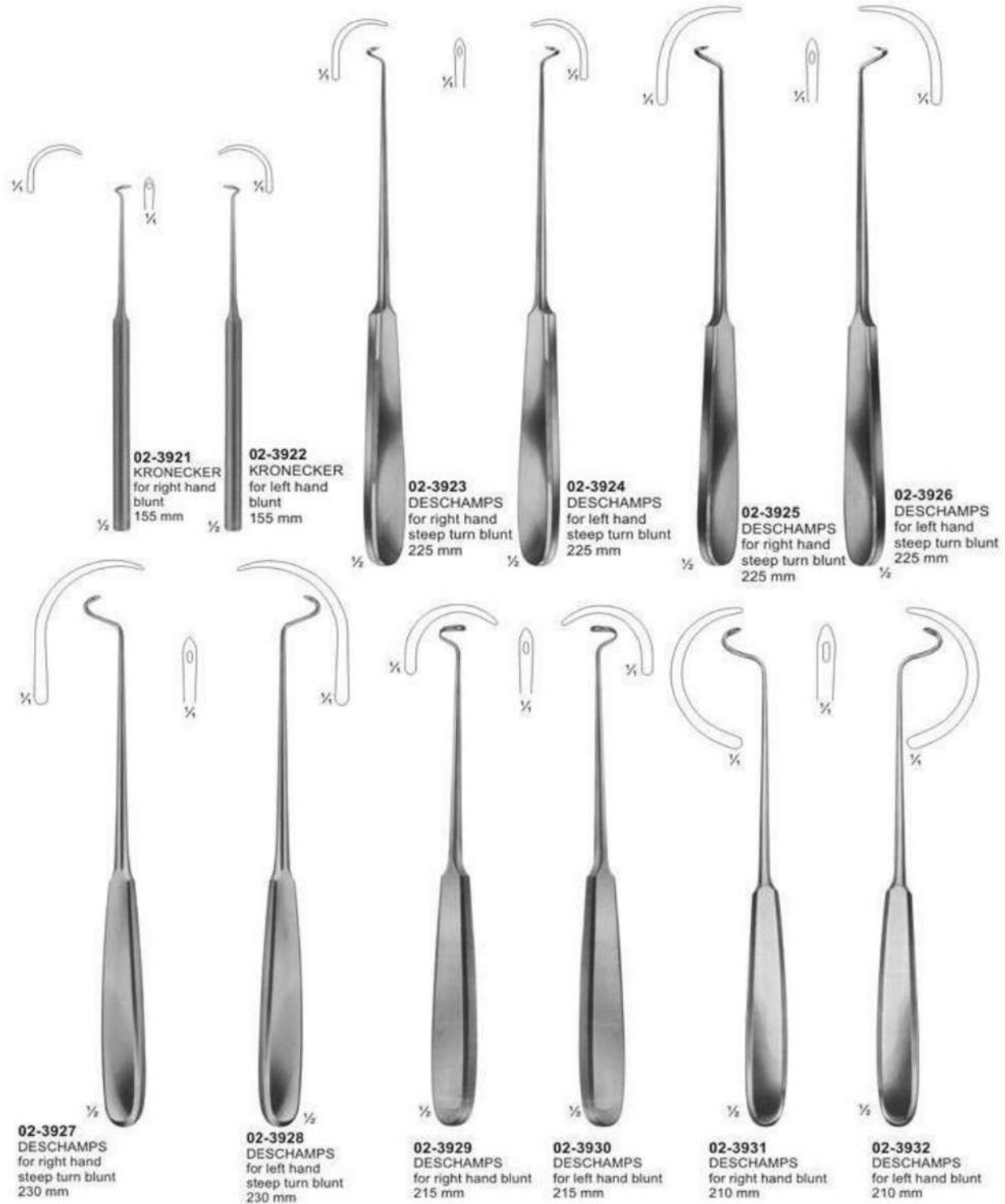

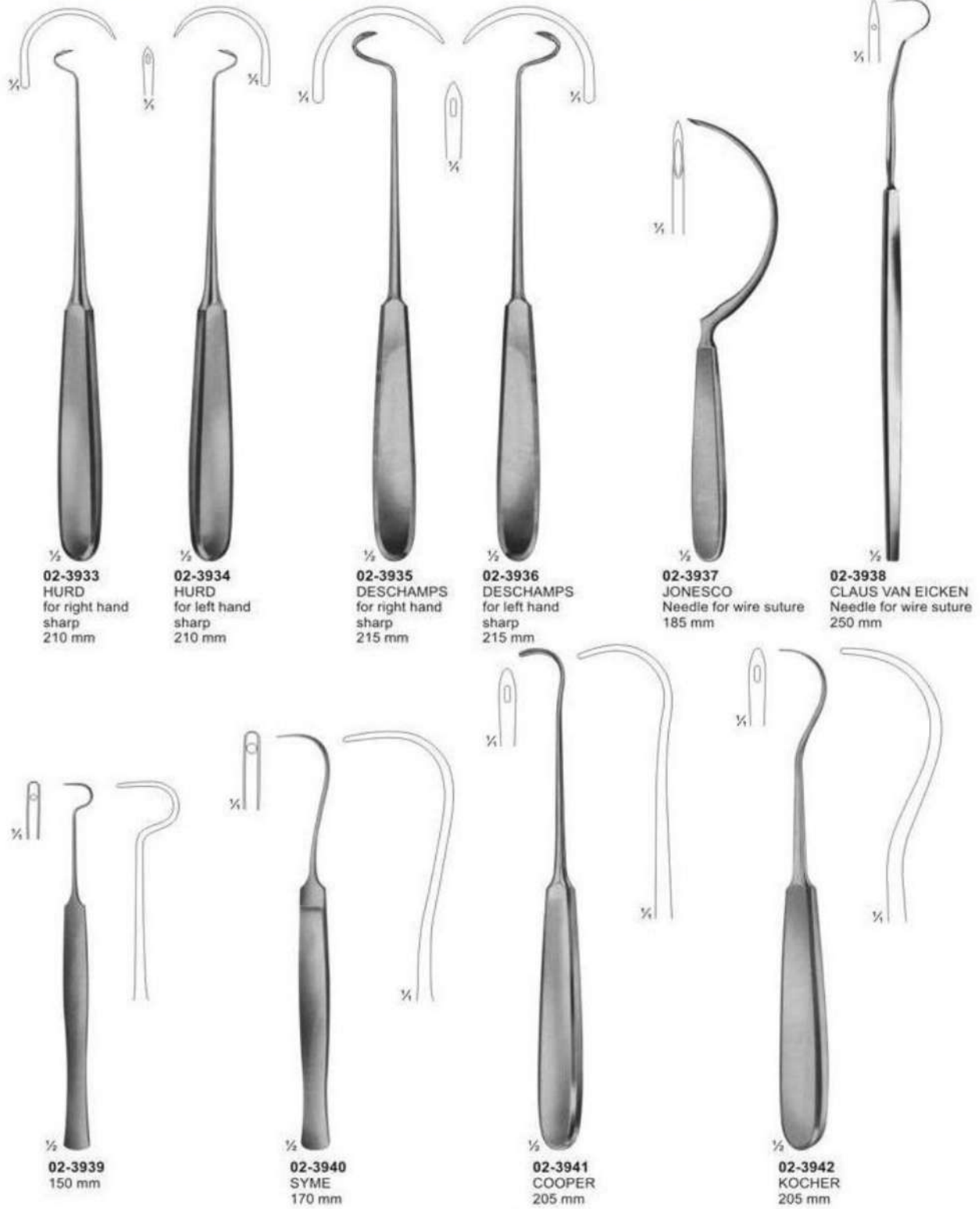



02-3943
BRUNNER
240 mm

02-3944
SCHMIEDEN-DICK
Malleable / Flexible
320 mm

02-3945 - 02-3946
BRUNNER
Guiding Probes
300 mm

02-3947

02-3948

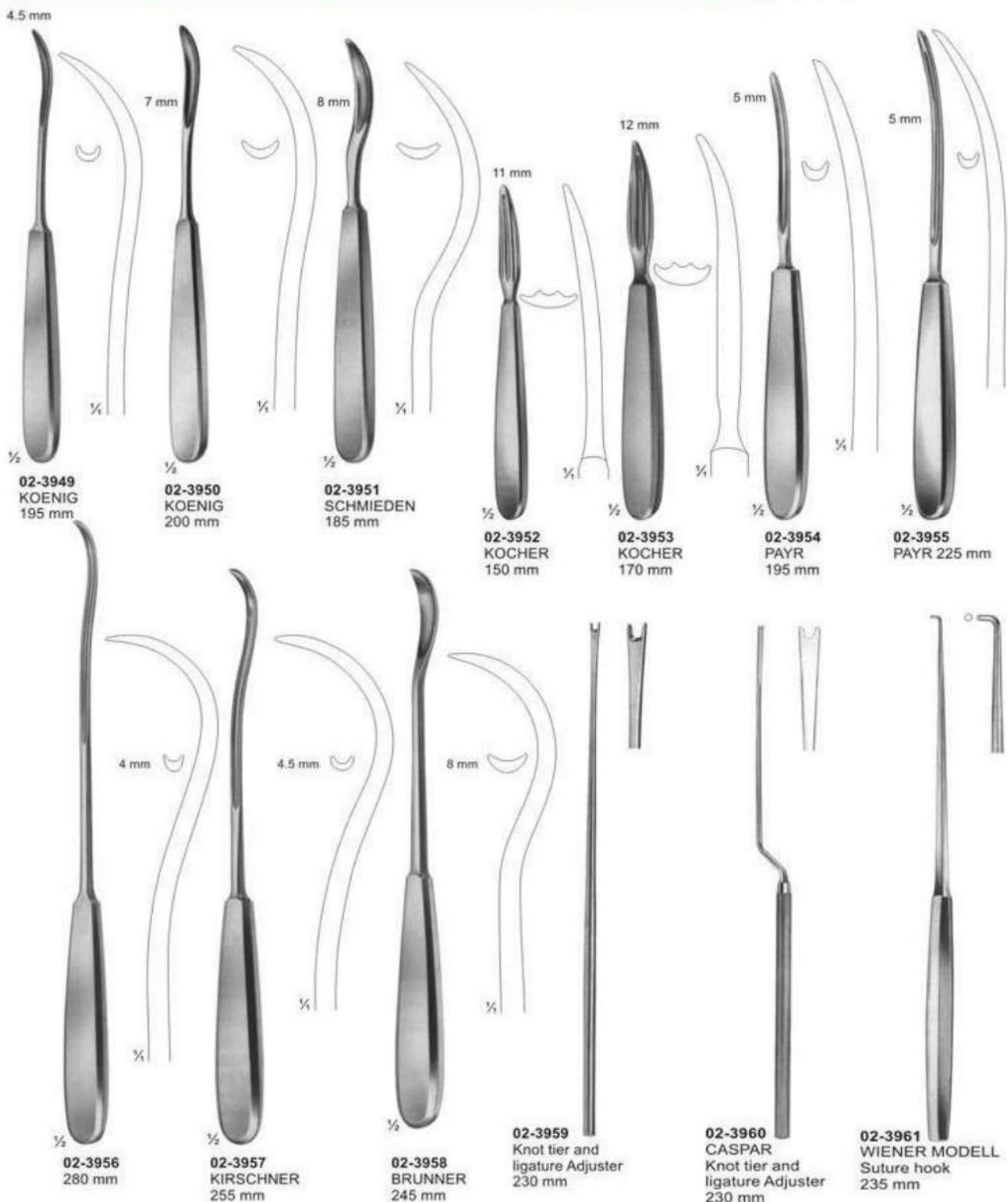



02-3962 - 02-3964
 02-3962 130 mm
 02-3963 145 mm
 02-3964 160 mm
 Directors

02-3965
 DOYEN
 145 mm
 Directors

02-3966
 NELATON
 160 mm
 Directors

02-3967
 Director with tip
 Diam. Of tip 3,3 mm
 140 mm

02-3968
 BRODIE
 Director with tip,
 Diam. Of tip 3,5 mm
 200 mm

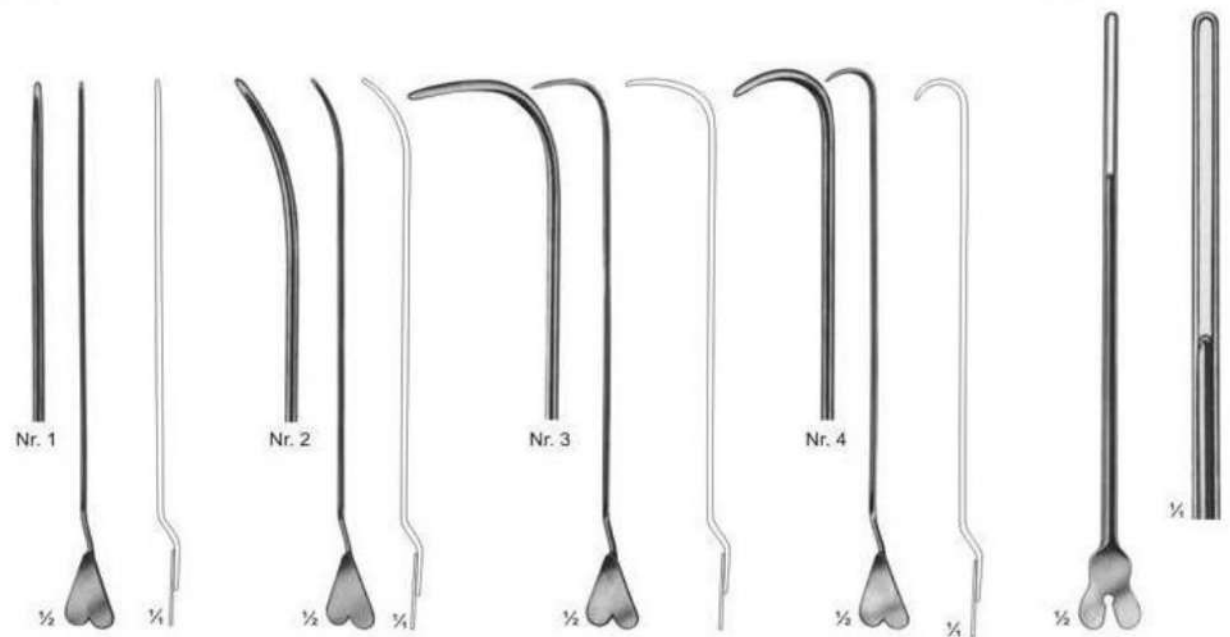

02-3969
 LOCKHART-MUMMERY
 165 mm
 Straight

02-3970
 LOCKHART-MUMMERY
 165 mm
 45° Curved

02-3971
 LOCKHART-MUMMERY
 165 mm
 90° Curved

02-3972
 LOCKHART-MUMMERY
 165 mm
 Retrograde Curved

02-3973
 Director with wire
 loop, malleable
 190 mm

02-3974
 2,5 mm \varnothing
 02-3975
 2,5 mm \varnothing
 02-3976
 3,0 mm \varnothing



1/2

02-3974 - 02-3976
 02-3974 145 mm
 02-3975 160 mm
 02-3976 200 mm
 Probes with eye

1,5 mm \varnothing



1/2

02-3977
 Myrtle leaf probe
 145 mm

2,0 mm \varnothing



1/2

02-3978 - 02-3982
 Myrtle leaf probe
 02-3978 130 mm
 02-3979 145 mm
 02-3980 160 mm
 02-3981 180 mm
 02-3982 200 mm

Diam of tips Length

Diam of tips	Length
02-3984	145mm
02-3985	145mm
02-3986	145mm
02-3991	145mm
02-3987	160mm
02-3992	160mm
02-3988	160mm
02-3993	160mm
02-3989	180mm
02-3994	180mm
02-3990	180mm
02-3995	200mm

02-3983
 Probes



1/2

02-3996
 Double ended probe,
 malleable, diam. of tips
 3 mm with hole
 190 mm



02-3997
 250mm 300mm
 Double ended probes,
 tin, malleable, diam. of tips
 3,5 mm with hole



1/4

02-3998
 Double ended probe,
 tin, malleable,
 diam. of tips 4 mm
 400 mm



1/2

\varnothing tip
 02-3999 - 02-4001
 02-3999 1,5 mm
 02-4000 2,0 mm
 02-4001 2,5 mm
 300 mm Probes



02-4002
STACKE
Silver
100 mm
∅ 0.8mm

02-4003
KILLIAN
165 mm
∅ 1.5mm

02-4004
160 mm
∅ 1.4mm

02-4005
SEIFFERT
Silver
180 mm
∅ 0.5mm

02-4006
BOWMAN
130 mm

German Silver

- 02-4007 - 02-4011**
- 02-4007** 0.7+0.8mm ∅ Fig. 00/0
 - 02-4008** 0.9+1.1mm ∅ Fig. 1/2
 - 02-4009** 1.3+1.4mm ∅ Fig. 3/4
 - 02-4010** 1.5+1.6mm ∅ Fig. 5/6
 - 02-4011** 1.8+1.9mm ∅ Fig. 7/8

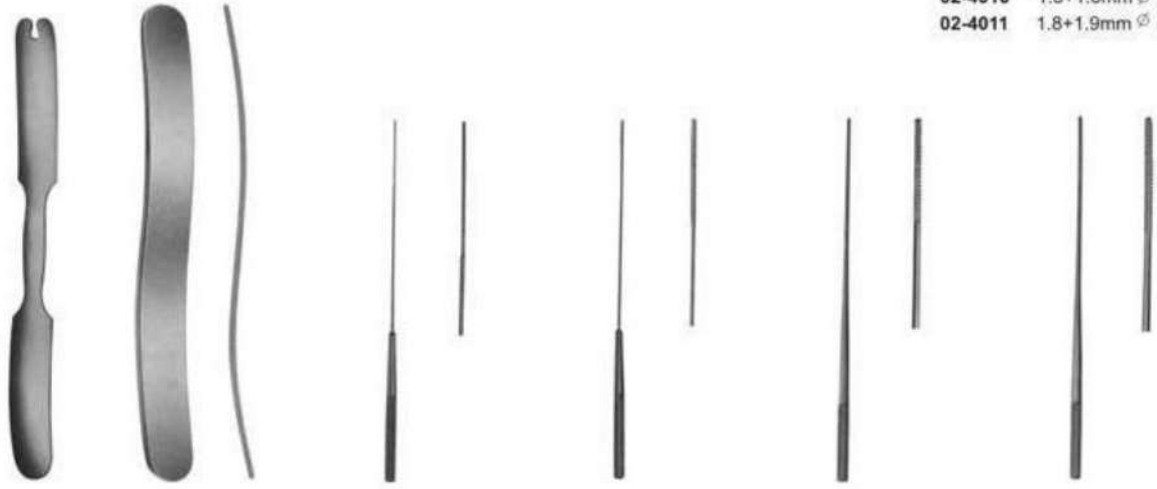

02-4012
SPATULA
145 mm

02-4013
SPATULA
145 mm

02-4014
Modell PICCOLO
Round Serrated end
110 mm 0.7mm

02-4015
Modell PICCOLO
Triangular Serrated end
110 mm 0.7mm

02-4016
FARRELL
Round Serrated end
110 mm 1.2mm

02-4017
LATHBURY-FARRELL
Triangular Serrated end
110 mm 1.4mm

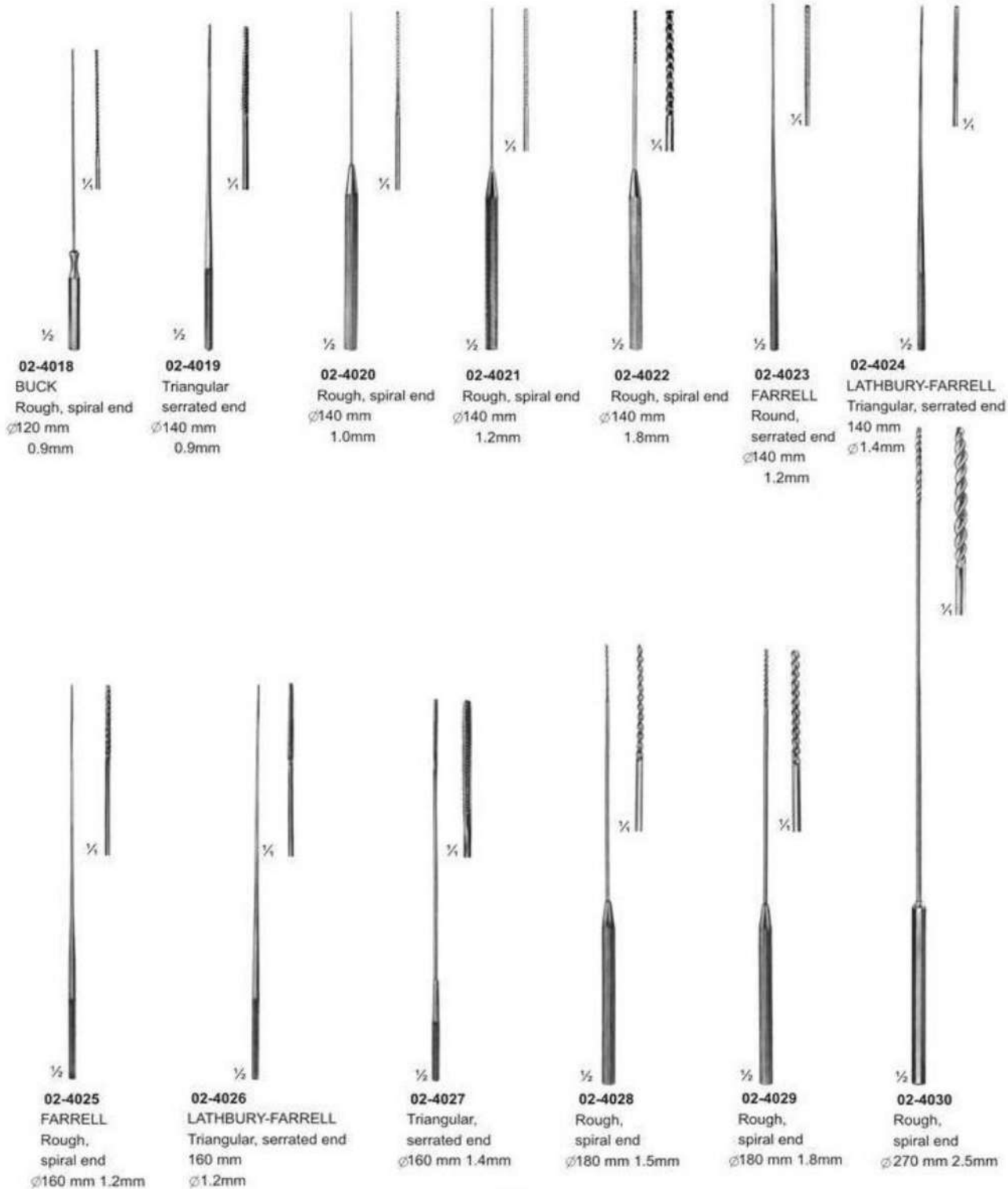



02-4031 MICHEL 125 mm



02-4032 HEGENBARTH 120 mm



02-4033 WACHENFELDT 120 mm



02-4034 WACHENFELDT 120 mm



02-4035 MICHEL 125 mm



02-4036 MICHEL modif. 130 mm



02-4037 HEATH 135 mm



02-4038 COLLIN 135 mm



02-4039

Suturing instruments set, in metal case consisting of:

- 1 Michel clip applying and removing forceps,
- 1 Scissors, curved, sharp/sharp, 115mm
- 25 MICHEL clips, 16 x 3mm
- 1 Delicate tissue forceps, 130mm
- 1 Scalpel, bellied
- 1 MATHIEU needle holder, 140mm
- 1 Perforated metal case, stainless

containing:

- 1 Suture needle
- 1 Suture needle
- 1 Suture needle



02-4040

Pocket instrument set, in metal case consisting of:

Bottom tray

- 1 MATHIEU needle holder, 140mm
- 1 MICHEL clip forceps, combined
- 1 Myrtle leaf probe, 130mm
- 1 Sharp double curette
- 1 Skin hook
- 1 Detachable scalpel handle, no.4
- 1 Perforated metal case, containing
- 6 Scalpel blades
- 1 Perforated metal case, stainless, containing
- 1 Suture needle
- 1 Suture needle
- 1 Suture needle

Top tray

- 1 Tissue forceps, 130mm
- 1 KOCHER haemostatic forceps, 130mm
- 1 Straight surgical scissors, 130mm
- 1 Dissecting forceps, 130mm
- 1 FEILCHENFELD splinter forceps, 115mm
- 25 MICHEL clip, 16 x 3mm
- 1 Flacon of suture skin, sterile in alcohol



02-4041

Pocket instrument set, in metal case consisting of:

Bottom tray

- 1 MAYO-HEGER needle holder, 150mm
- 1 MICHEL clip forceps, combined
- 1 Myrtle leaf probe, 130mm
- 1 Sharp double curette
- 1 Skin hook
- 1 Detachable scalpel handle, no. 4
- 1 Perforated metal case, consisting
- 6 Scalpel blades
- 1 Perforated metal case, stainless, consisting:
- 1 Suture needle
- 1 Suture needle
- 1 Suture needle

Top tray

- 1 Tissue forceps, 130mm
- 1 CRILE haemostatic forceps, 140mm
- 1 Straight surgical scissors, 130mm
- 1 Dissecting forceps, 130mm
- 1 FEILCHENFELD splinter forceps, 115mm
- 25 MICHEL clip, 16 x 3mm
- 1 Flacon of suture silk, sterile in alcohol



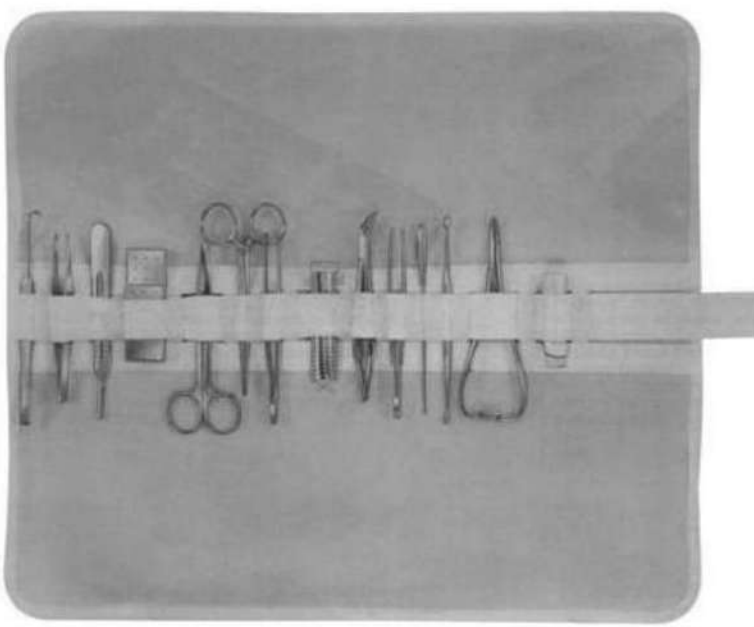

02-4042
 Pocket instrument set in metal case 170 x 90mm
 canvas roll only, sterilizable in autoclave.
 consisting of:
 1 Myrtle leaf probe, 130mm
 1 Sharp double curette
 1 FEILCHENFELD splinter forceps, 115mm
 1 Dissecting forceps, 130mm 1 Tissue forceps, 130mm

1 Straight surgical scissors, 130mm
 1 Scalpel handle no. 4
 1 Perforated metal case, consisting
 6 scalpel blades
 1 KOCHER haemostatic forceps, 130mm
 1 Skin hook
 1 MATHIEU needle holder, 140mm
 1 Tube of suture skin, sterile in alcohol
 1 MICHEL clip forceps, 120mm

25 MICHEL clip, 16 x 3mm
 1 Perforated metal case, stainless,
 consisting:
 1 Suture needle
 1 Suture needle
 1 Suture needle

02-4043
 Canvas roll only, sterilizable in
 autoclave
Suitable Metal Cases

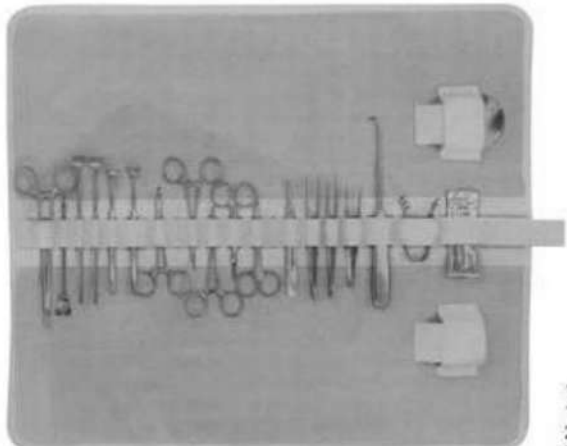

02-4044
 Venae sectio set, canvas roll only, sterilizable in autoclave.
 consisting of:
 2 Tissue forceps, 1 x 2 teeth, 140mm
 1 Dissecting forceps, 145mm
 1 FEILCHENFELD splinter forceps, 115mm
 1 Straight scissors, sharp, 110mm
 1 Curved scissors, blunt, 115mm
 3 HALSTED mosquito forceps, curved on flat, 125mm

250 x 125 x 55mm
 233 x 148 x 57mm
 1 DESCHAMPS needle, blunt, 210mm
 1 DOYEN Director, curved, 140mm
 2 Wound retractors, 4 blunt prongs, 160mm
 2 DESMARRES wound retractors, 135mm
 1 FINSSEN retractors, 2 x3 blunt prongs, 80mm
 1 Scalpel handle no. 4
 4 Sterile scalpel blades, no 18, single peel pack
 1 Needle box, perforated, round, diam. 65mm
 1 HEGAR-MAYO DUROGRIP needle holder, 180mm

02-4045
 Canvas roll only, sterilizable in autoclave



02-4046

Venae sectio set, in metal case
consisting of:

Bottom tray

- 1 MATHIEU needle holder, fine pattern 140mm
- 1 Ligature needle, fine short pattern
- 1 DOYEN director, curved
- 1 HEGENBARTH clip forceps,
- 1 ELSCHNIG tissue forceps, 1 x 2 teeth fine, 105mm
- 1 Dressing forceps, fine 105mm
- 1 Tissue forceps, 1 x 2 teeth, 110mm
- 1 Vessel scissors, straight, with 1 ball point, 110mm
- 1 Vessel scissors, curved, pointed 105mm
- 1 FINSSEN retractor
- 1 Perforated needle case

Top tray

- 1 Scalpel, pointed
- 1 Scalpel, bellied
- 2 HALSTED mosquito forceps, curved, 125mm
- 2 HALSTED mosquito forceps, straight, 1x 2 teeth, 125mm
- 3 BACKHAUS towel forceps, 90mm
- 2 Flacon holder

Section - 03



- ★ Hooks, Retractors, Spatulas, Spreaders, Abdoninal Retractors
- ★ Forceps, intestinal Clamps, Specula, Biopsy Forceps, Anusopes
- ★ Gall Duct Forceps / Probes / Scissors / Kidney Forceps, Urinary Instruments, Trocars

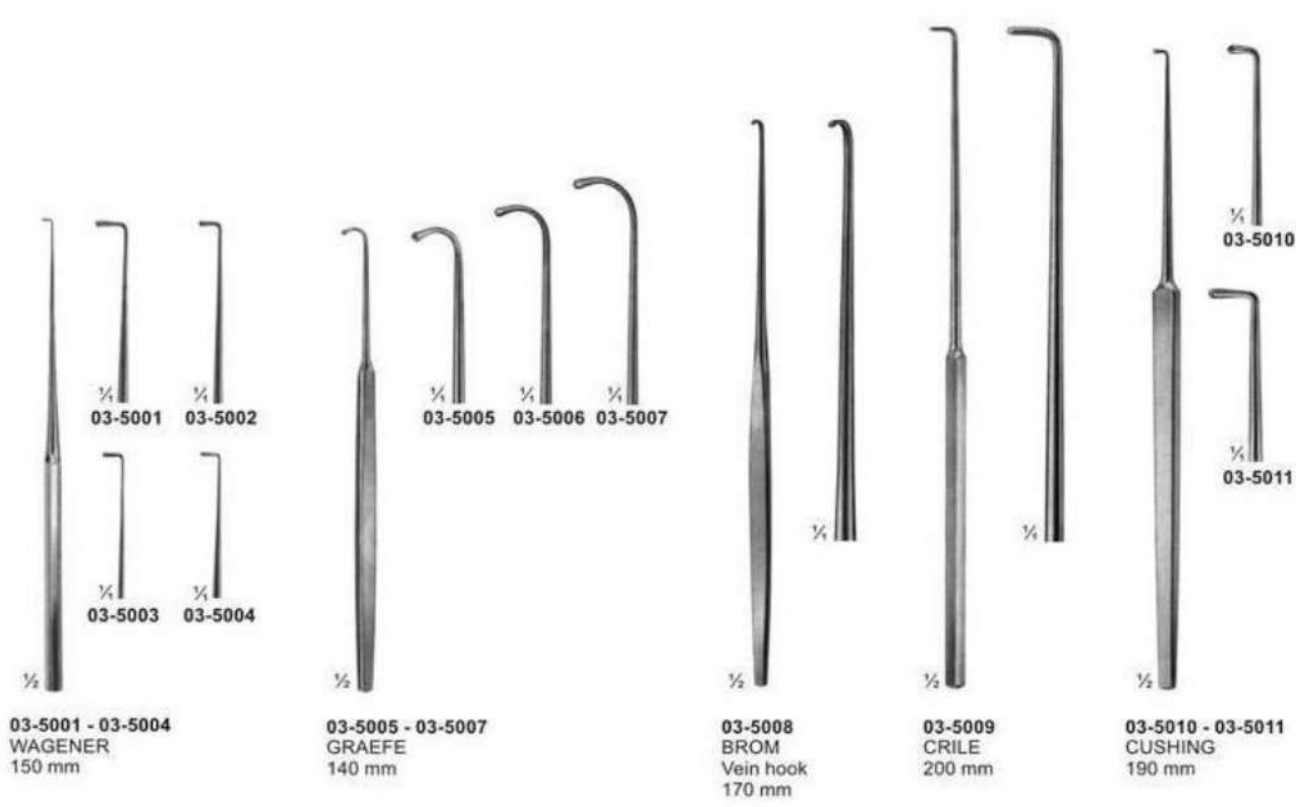

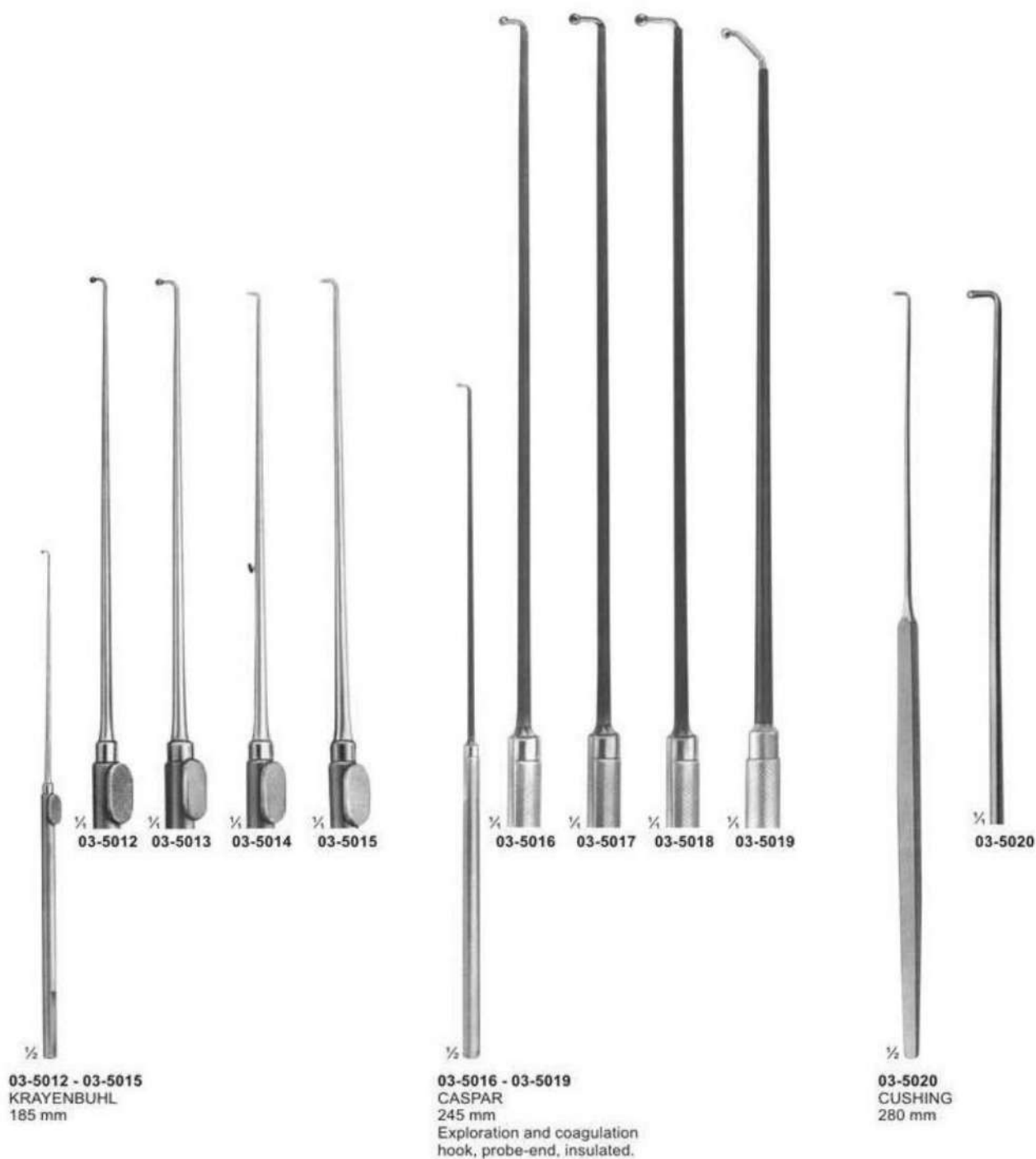

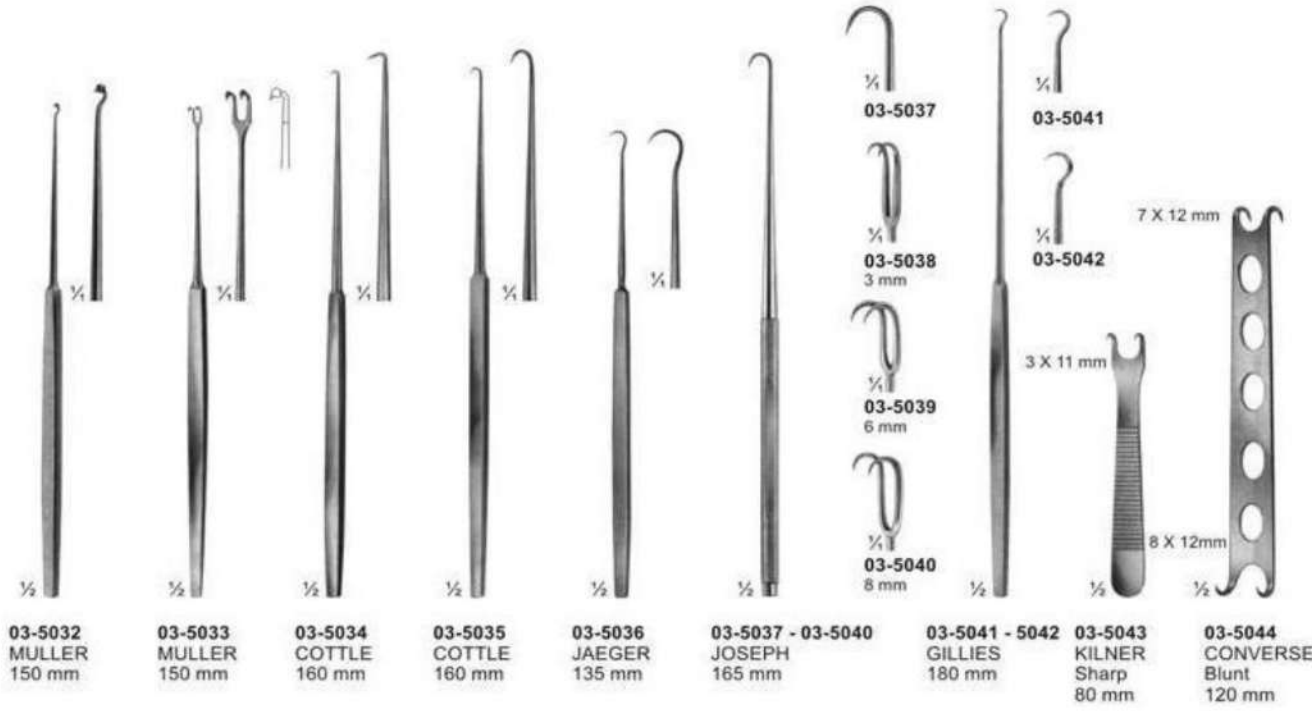
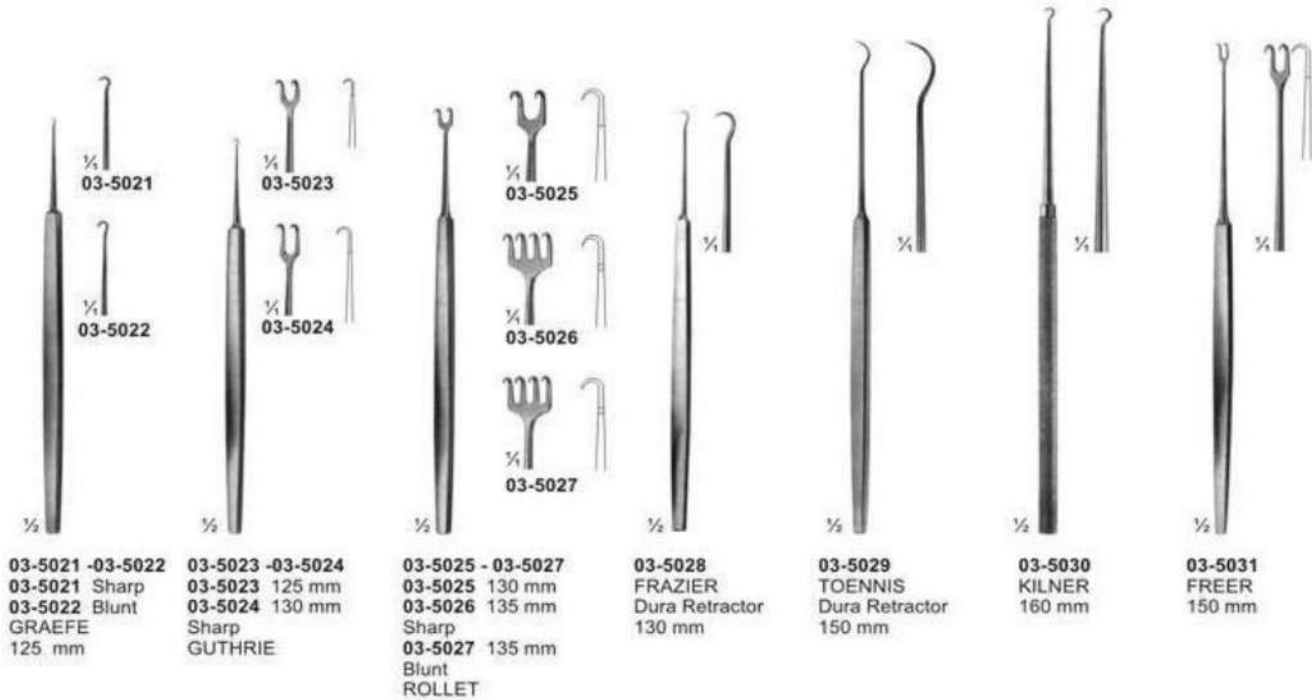

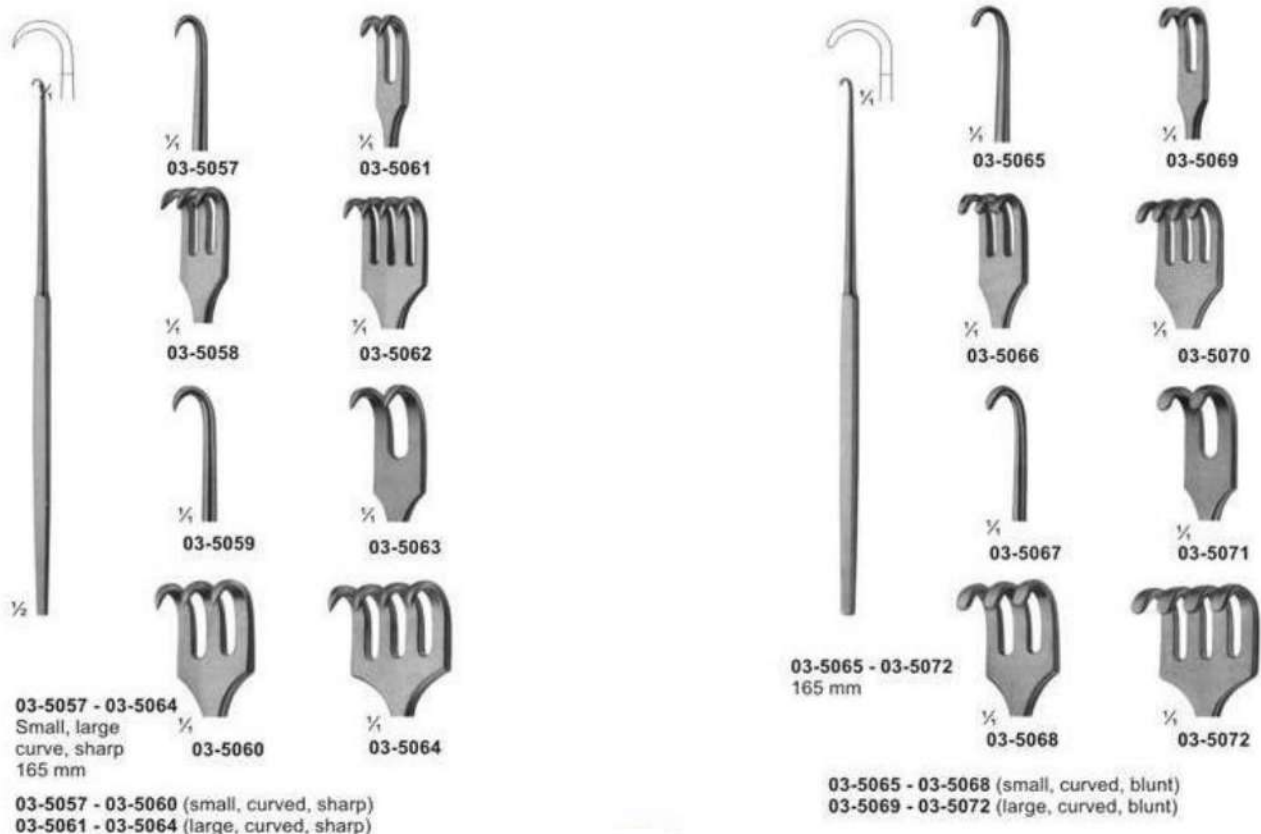

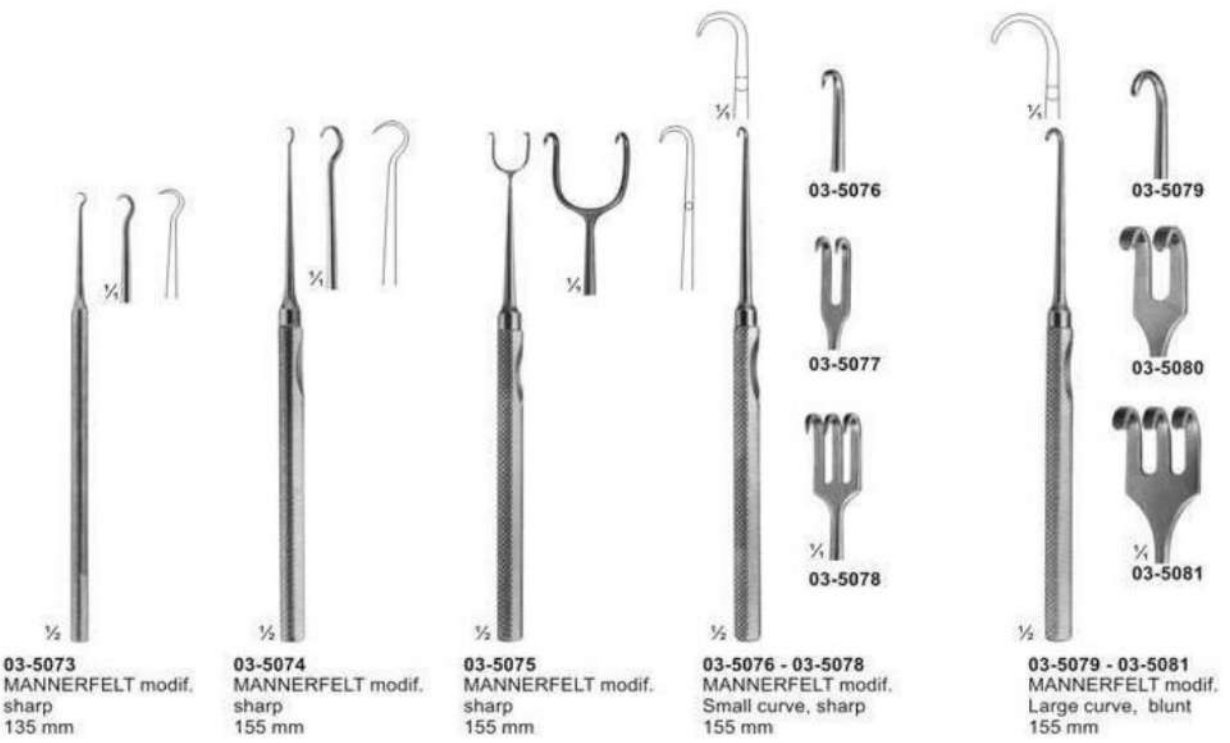

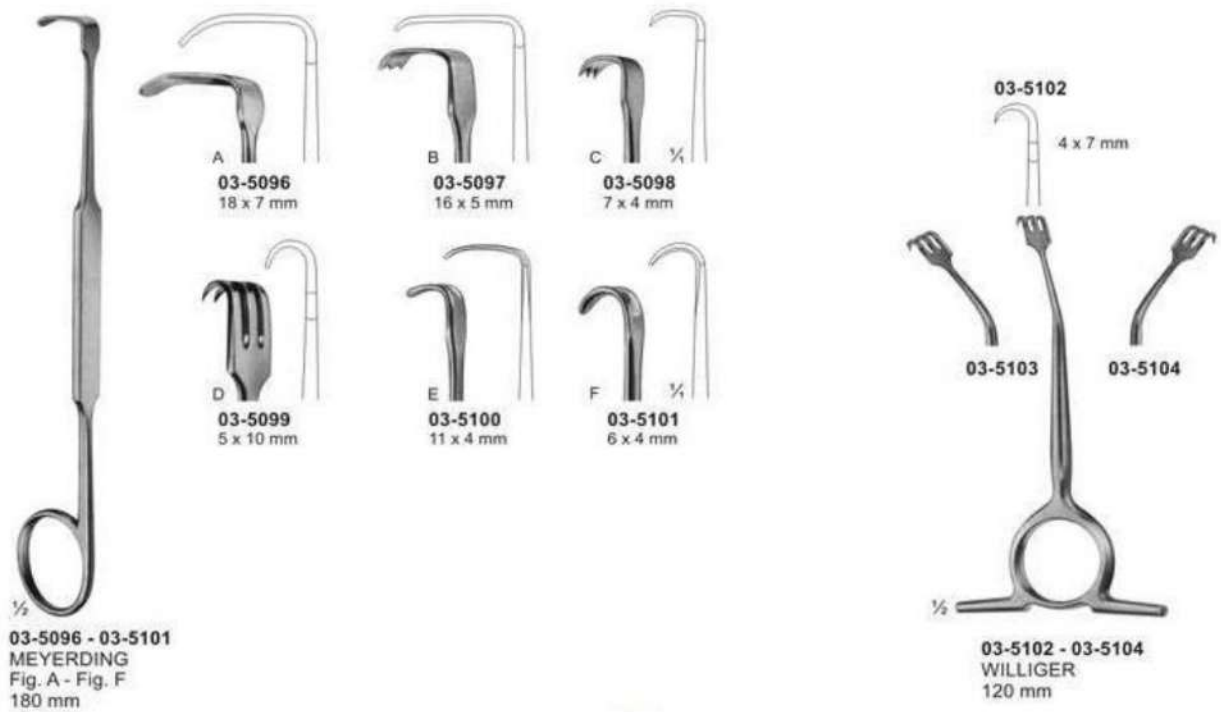



03-5105 EMMET
Fistula hook
220 mm



03-5106 SIMON
Fistula hook
220 mm



03-5107 SIMON
Fistula hook
220 mm



03-5108 LANGE
Fistula hook
230 mm



03-5109 - 03-5110
Tendon hooks
175 mm

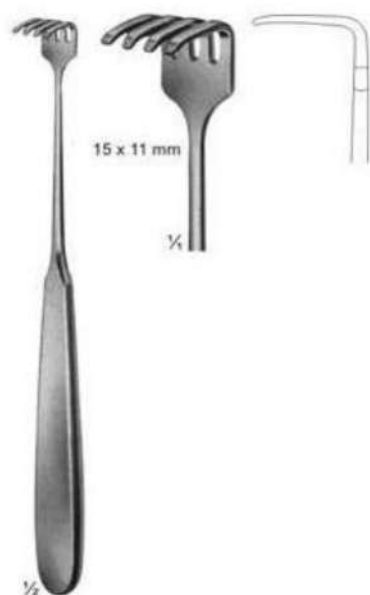

03-5111 KLAPP
Tendon hooks
175 mm





03-5131 - 03-5132
BABY-SENN-MILLER
155 mm

03-5133
SENN-MILLER
165 mm

03-5134
COLLIN-HARTMANN
150 mm

03-5135 - 03-5137
STERNBERG
03-5135 120 mm
03-5136 130 mm
03-5137 135 mm

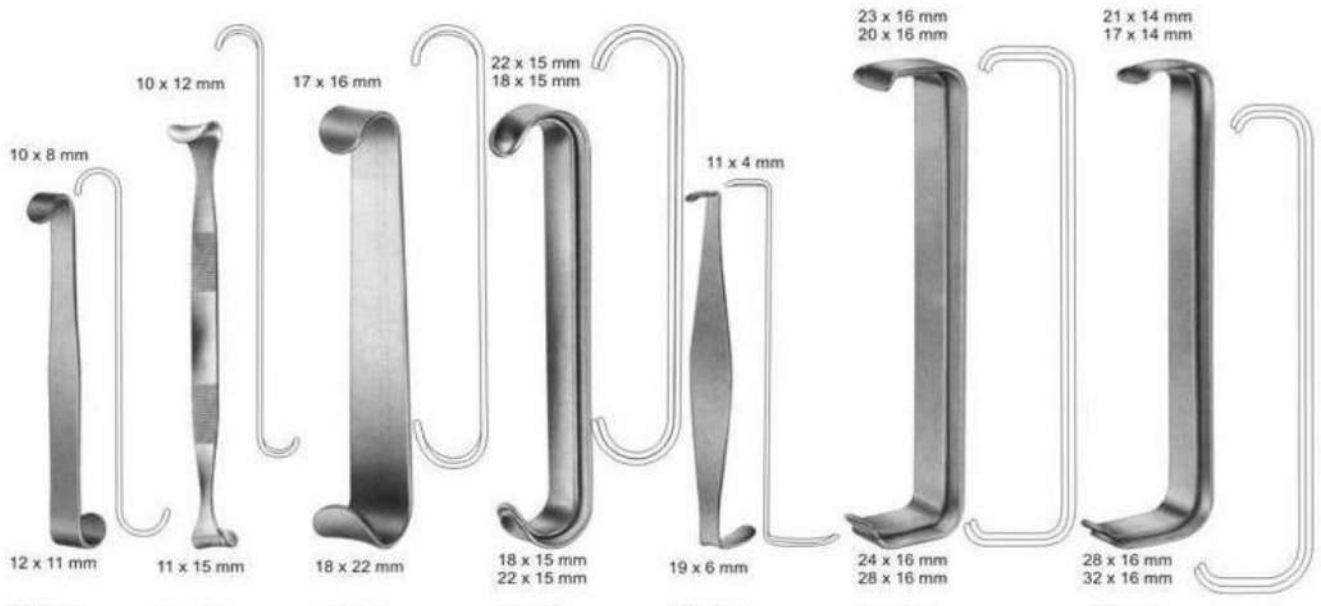

03-5138
LUER
110 mm

03-5139
ROSE
130 mm

03-5140
BABY-ROUX
135 mm

03-5141
PARKER
135 mm

03-5142
CRILE
110 mm

03-5143
FARABEU
150 mm

03-5144
COLLIN
150 mm





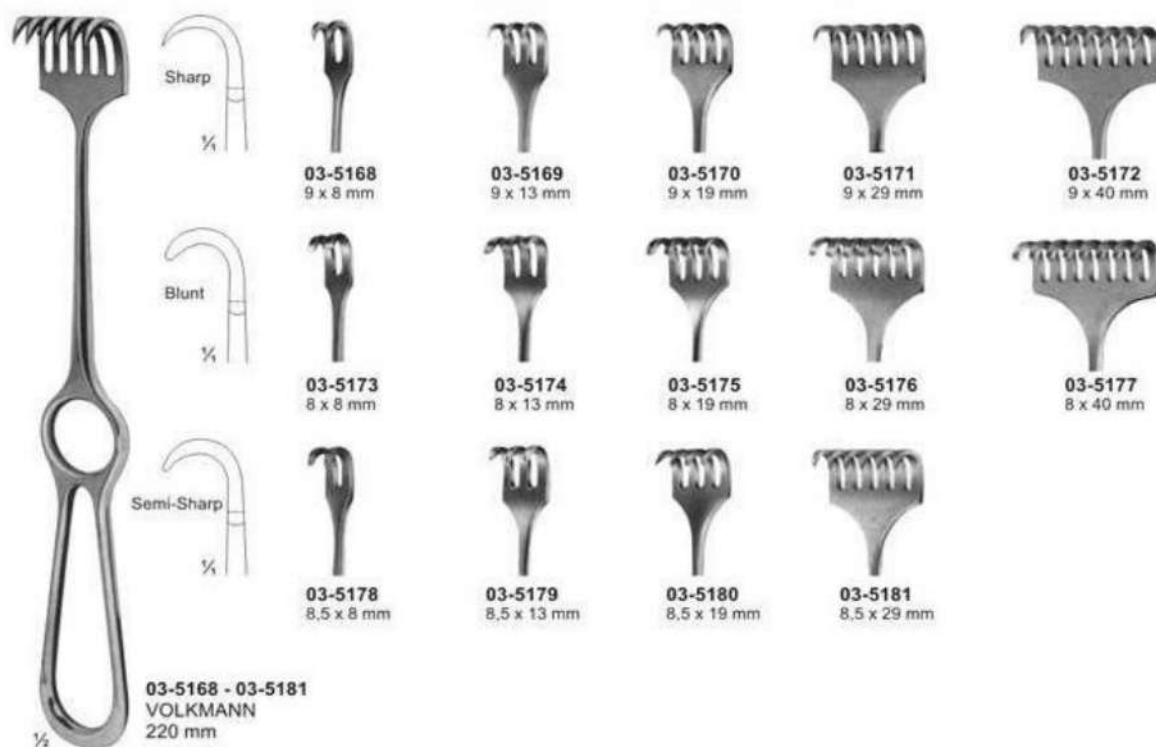

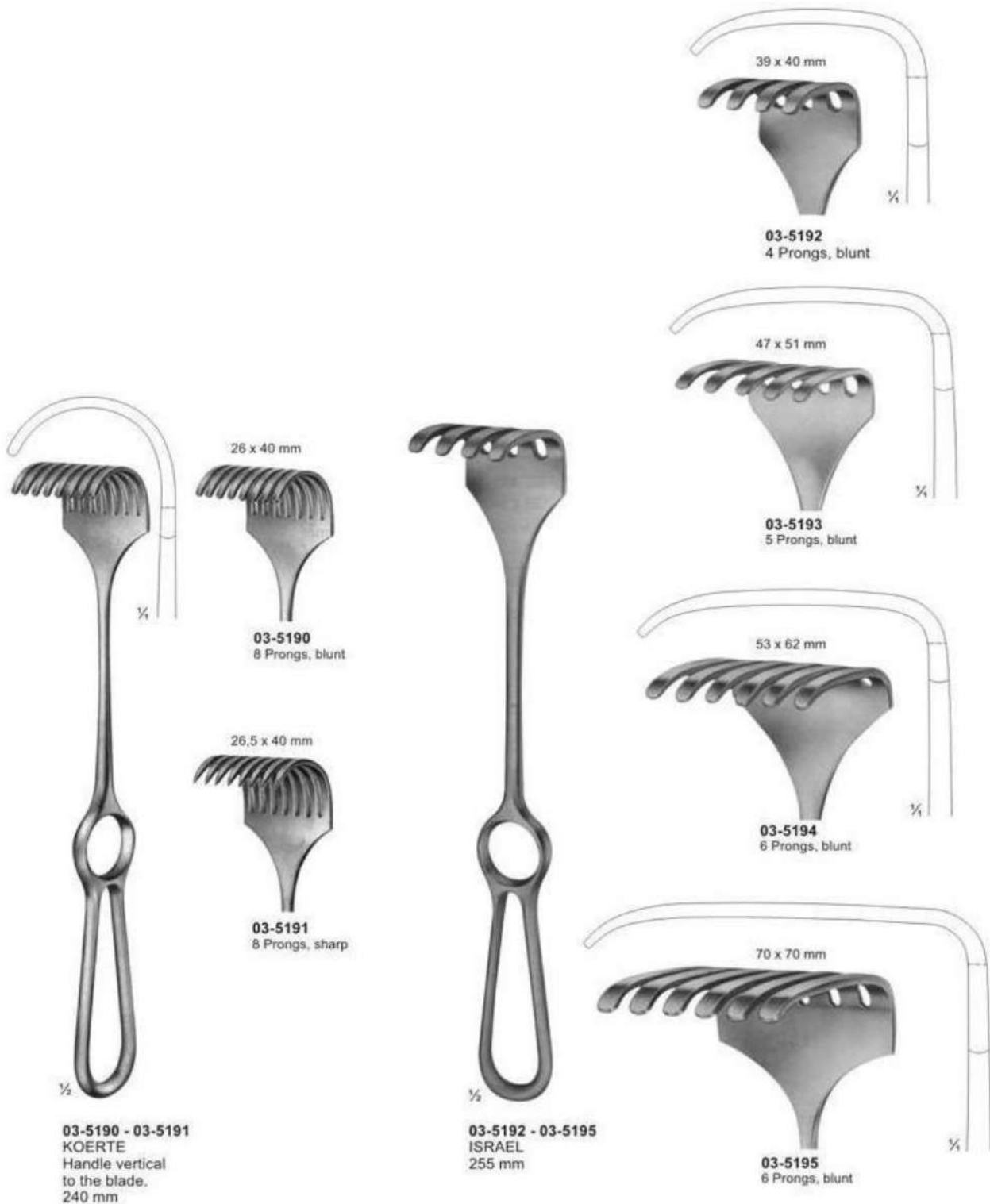



03-5196 - 03-5201
LANGENBECK
210 mm

03-5196	28 x 10 mm
03-5197	28 x 14 mm
03-5198	33 x 14 mm
03-5199	28 x 16 mm
03-5200	40 x 10 mm
03-5201	40 x 13 mm



03-5202 - 03-5210
KOCHER-LANGENBECK
215 mm

03-5202	25 x 6 mm
03-5203	35 x 8 mm
03-5204	35 x 11 mm
03-5205	35 x 15 mm
03-5206	41 x 11 mm
03-5207	55 x 11 mm
03-5208	70 x 14 mm
03-5209	80 x 12mm
03-5210	80 x 16mm



03-5211
LANGENBECK
215 mm

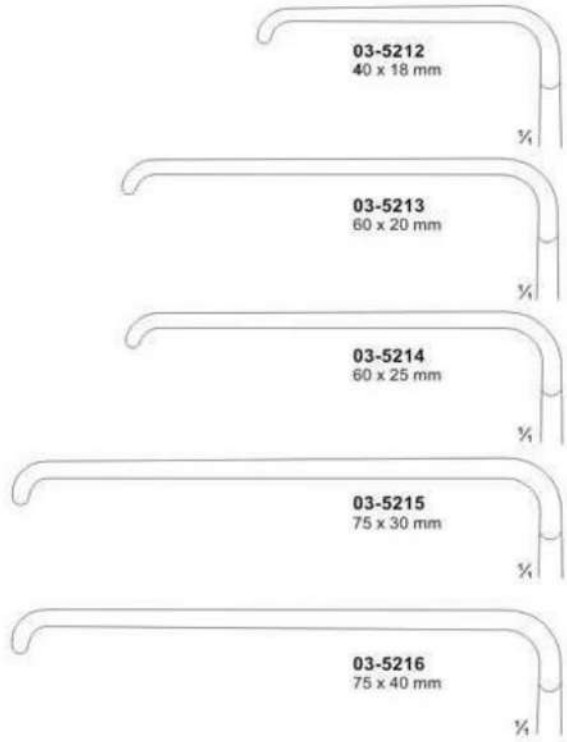

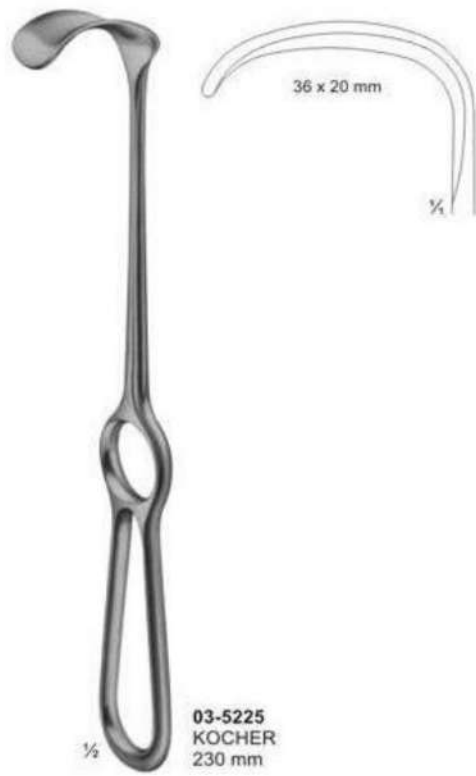
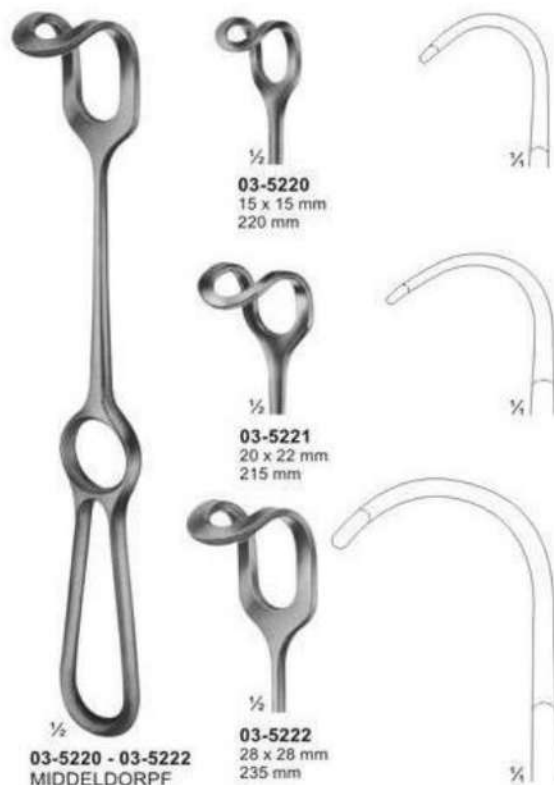



03-5226 - 03-5231
HOSEL
250 mm



03-5226
60 x 20 mm

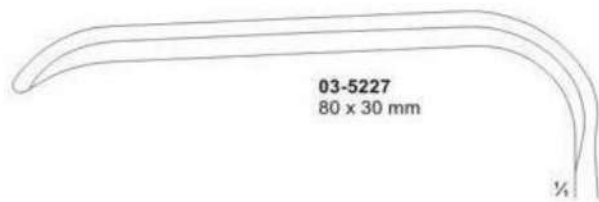

03-5227
80 x 30 mm

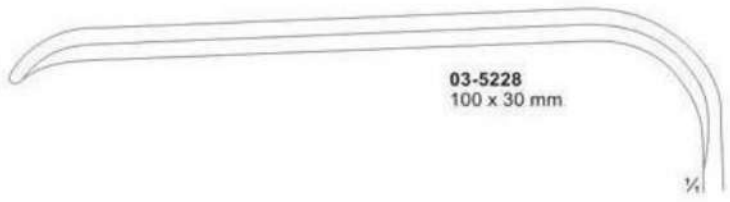

03-5228
100 x 30 mm

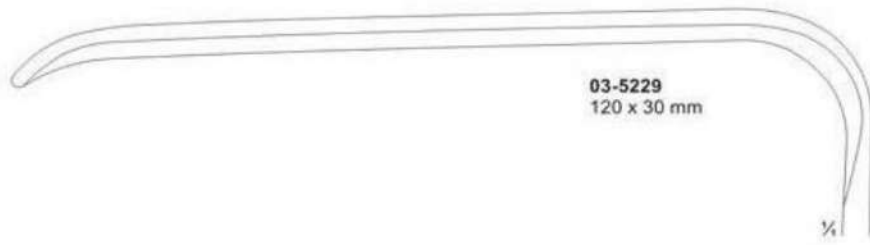

03-5229
120 x 30 mm

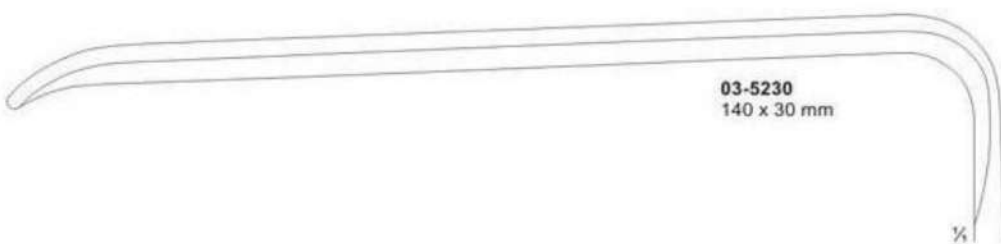

03-5230
140 x 30 mm



03-5231
140 x 40 mm



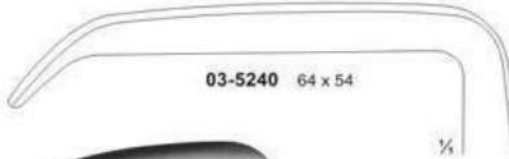
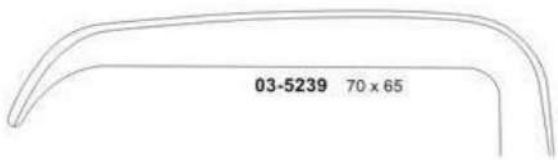

03-5239 - 03-5240
KELLY
260 mm

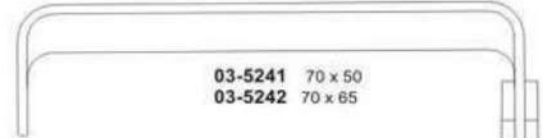

03-5241 - 03-5242
MORRIS
245 mm





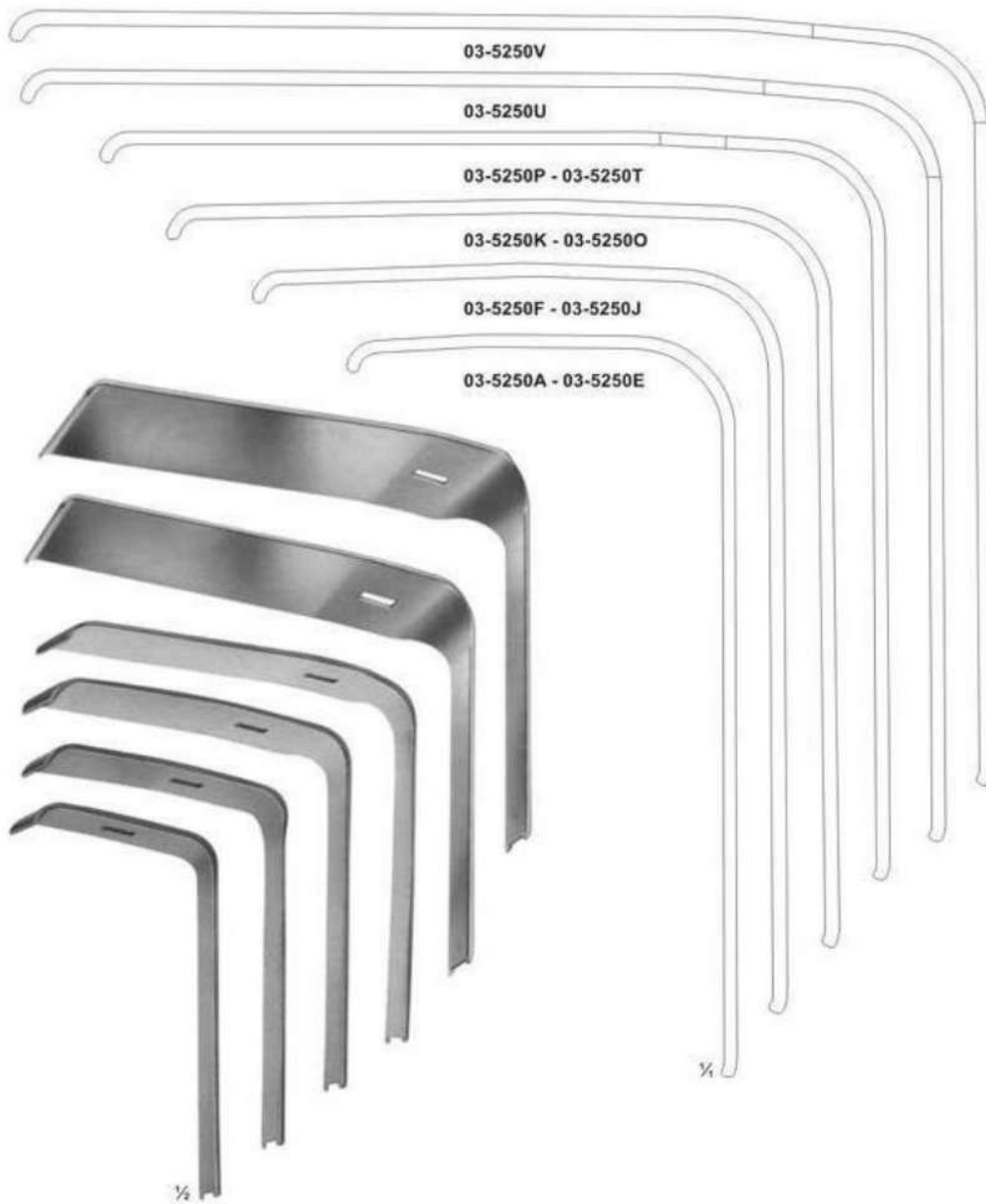

Retractor blades for handles 03-5250

Depth	Width						50mm
	14mm	18mm	22mm	26mm	30mm	40mm	
55mm	03-5250A	03-5250B	03-5250C	03-5250D	03-5250E	-	-
75mm	03-5250F	03-5250G	03-5250H	03-5250I	03-5250J	-	-
95mm	03-5250K	03-5250L	03-5250M	03-5250N	03-5250O	-	-
115mm	03-5250P	03-5250Q	03-5250R	03-5250S	03-5250T	-	-
135mm	-	-	-	-	03-5250U	-	-
145mm	-	-	-	-	-	-	03-5250V



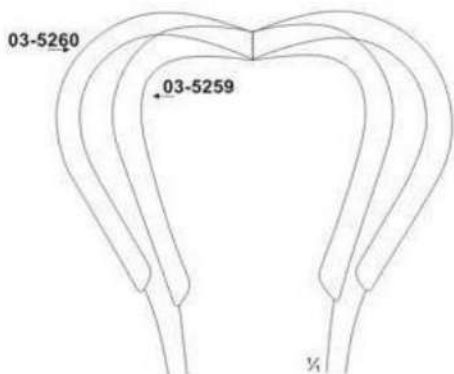

03-5259 - 03-5260
HARRINGTON
03-5259 123 x 45 mm
03-5260 123 x 64 mm
Flexible
295 mm



03-5261
ALLISON
255 mm



03-5262
ALLISON
320 mm







03-5274
DEAVER
300 mm
Fig. 3

03-5275
DEAVER
310 mm
Fig. 4

03-5276
DEAVER
320 mm
Fig. 5



03-5277
DEAVER
310 mm
Fig. 1



03-5278
DEAVER
310 mm
Fig. 3



03-5279
DEAVER
305 mm
Fig. 4



03-5280
DEAVER
310 mm
Fig. 5





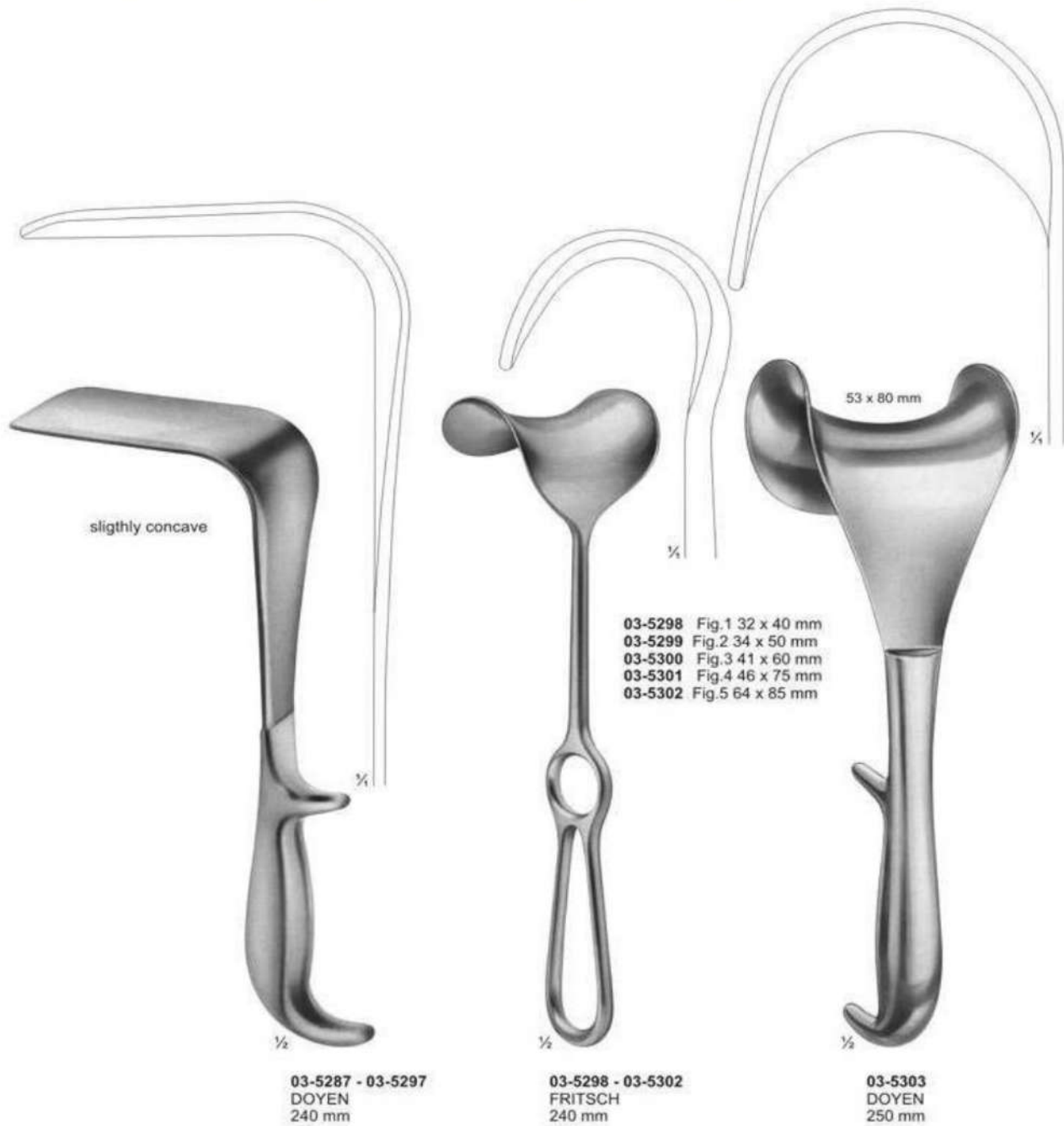

Length of Blades	Width of Blades		
	35mm	45mm	60mm
62mm	03-5287	03-5290	03-5294
92mm	03-5288	03-5291	03-5295
122mm	03-5289	03-5292	03-5296
160mm		03-5293	03-5297



03-5304 - 03-5308
ROCHARD
 310 mm
03-5304 48 x 90 mm
03-5305 48 x 105 mm
03-5306 48 x 120 mm
03-5307 48 x 135 mm
03-5308 48 x 155 mm



03-5309
ROCHARD
 Fixation device for



03-5310 - 03-5313
DOYEN
 280 mm
03-5310 48 x 90 mm
03-5311 48 x 105 mm
03-5312 48 x 120 mm
03-5313 48 x 135 mm



03-5314
DOYEN-CHILD
 Fixation device
 220 mm



03-5315
 Chain
 with weight
 645g
 790 mm

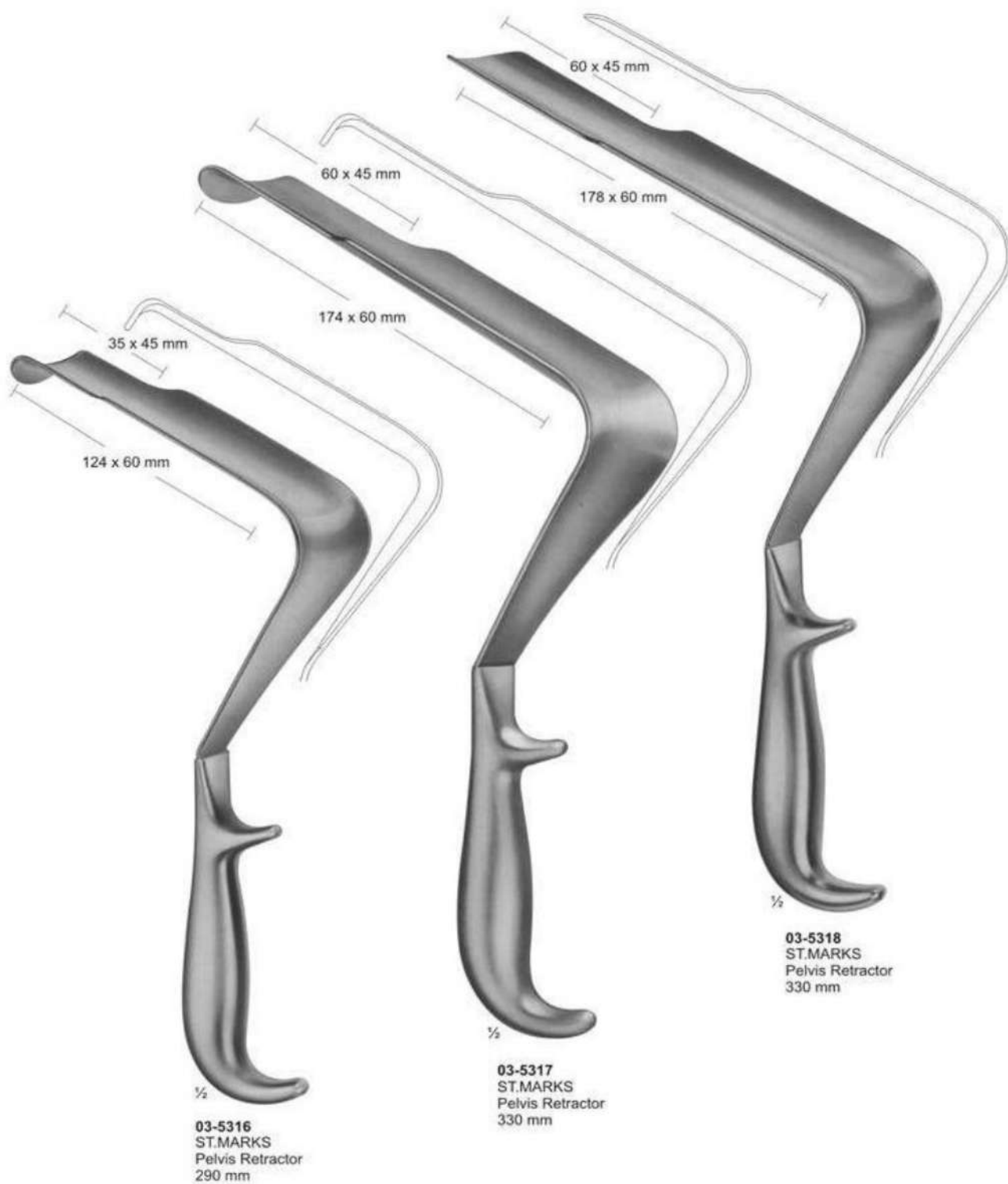





03-5324
REVERDIN
285 mm



03-5325
HABERER
Malleable
305 mm



03-5326 - 03-5328
03-5326 30 mm
03-5327 40 mm
03-5328 50 mm
Malleable
330 mm



03-5329
TUFFIER
Malleable
200 mm

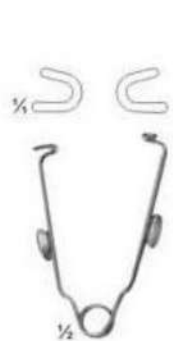

03-5330
BOSE
60 mm



03-5331
FINSEN
50 mm



03-5332
FINSEN
70 mm



03-5333
FINSEN modif.
75 mm



03-5334
45 mm



03-5335
55 mm



03-5336
MUELLER
65 mm



03-5337
100 mm



03-5338 **03-5339**



03-5338 - **03-5339**
03-5338 70 mm
03-5339 100 mm

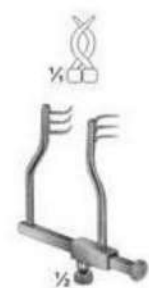

03-5340
LOGAN
modif. REILL
50 mm

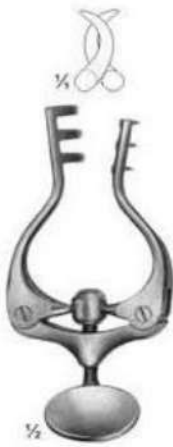

03-5341
JANSEN
100 mm



03-5342
JANSEN
100 mm

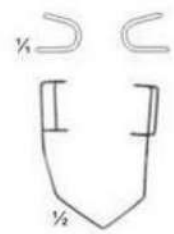

03-5343
BARRAQUER
45 mm



03-5344
WEITLANER
Sharp
110 mm



03-5345
WEITLANER
Semi-Sharp
110 mm



03-5346
WEITLANER
Blunt
110 mm



03-5347
WEITLANER
Sharp
130 mm



03-5348
WEITLANER
Semi-Sharp
130 mm



03-5349
WEITLANER
Blunt
130 mm

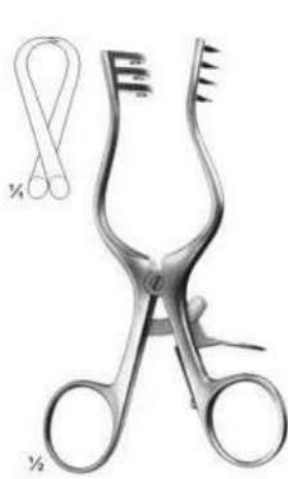

03-5350
WEITLANER
Sharp
130 mm

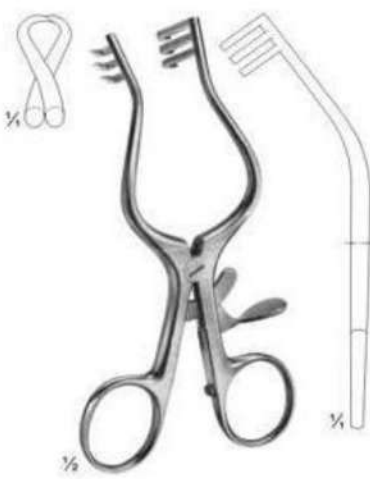

03-5351
WULLSTEIN
Sharp
130 mm

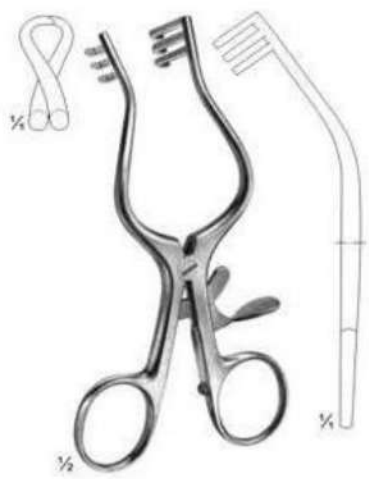

03-5352
WULLSTEIN
Blunt
130 mm



03-5353
WEITLANER
Sharp
165 mm



03-5354
PLESTER
Blunt
110 mm

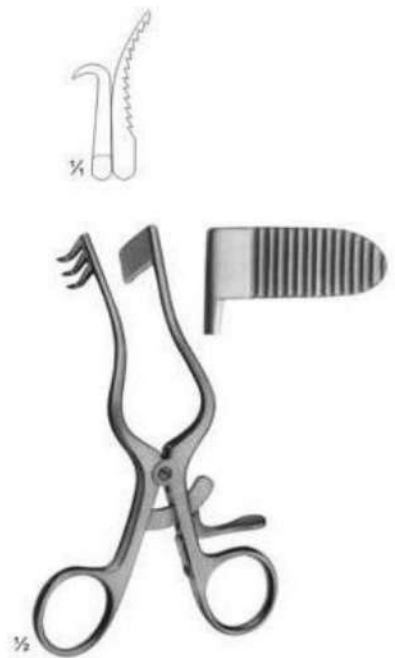

03-5355
PERKINS
Blunt
130 mm



03-5356
ADSON-BABY
Blunt
140 mm

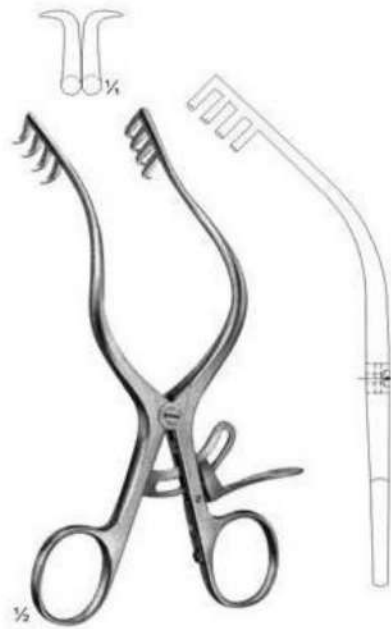

03-5357
MOLLISON
Sharp
155 mm



03-5358
MAYO-ADAMS
165 mm

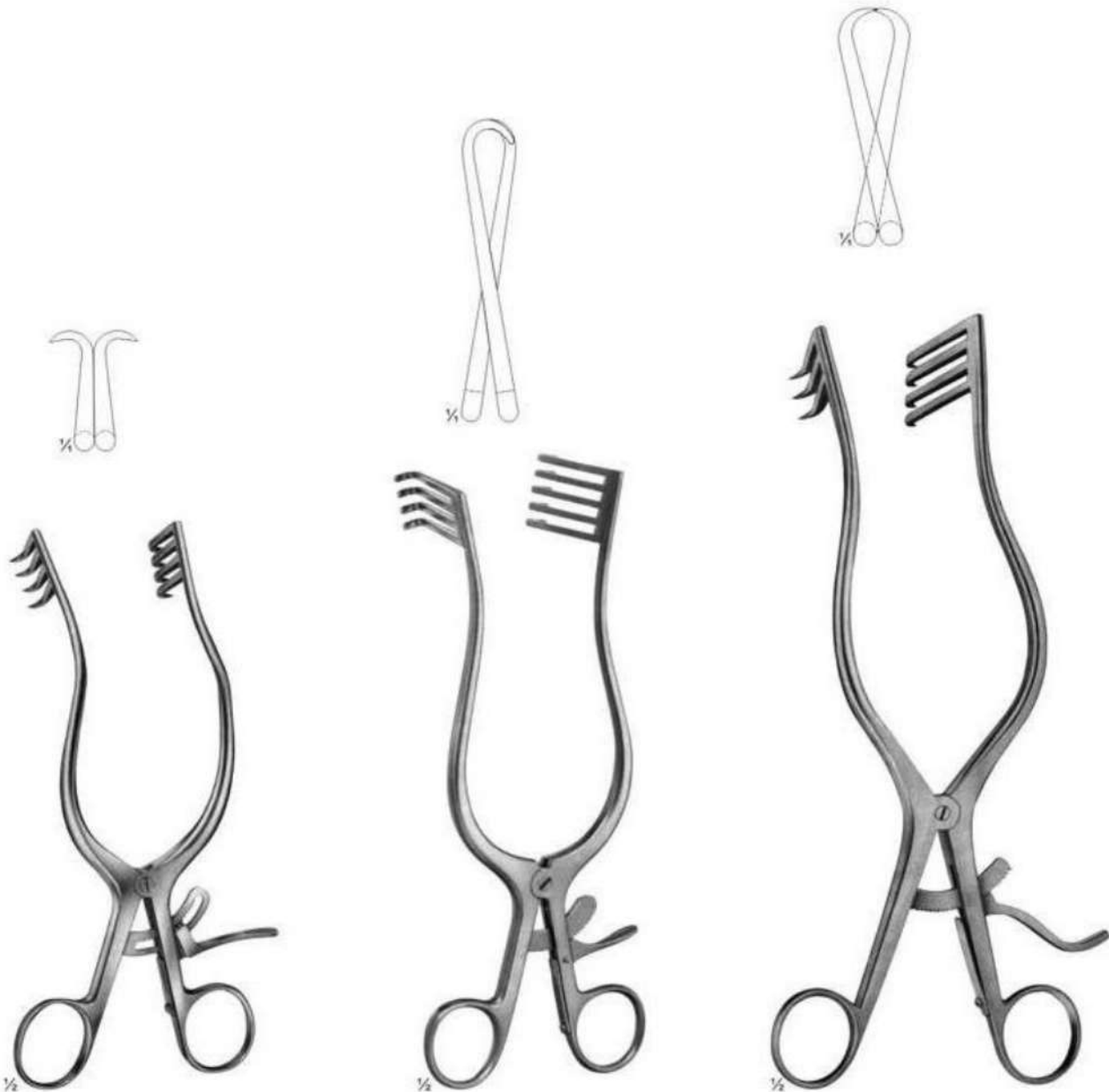

03-5359
ANDERSON-ADSON
Sharp
190 mm

03-5360
NORFOLK and
NORWICH
Blunt
220 mm

03-5361
ADSON
Sharp
265 mm

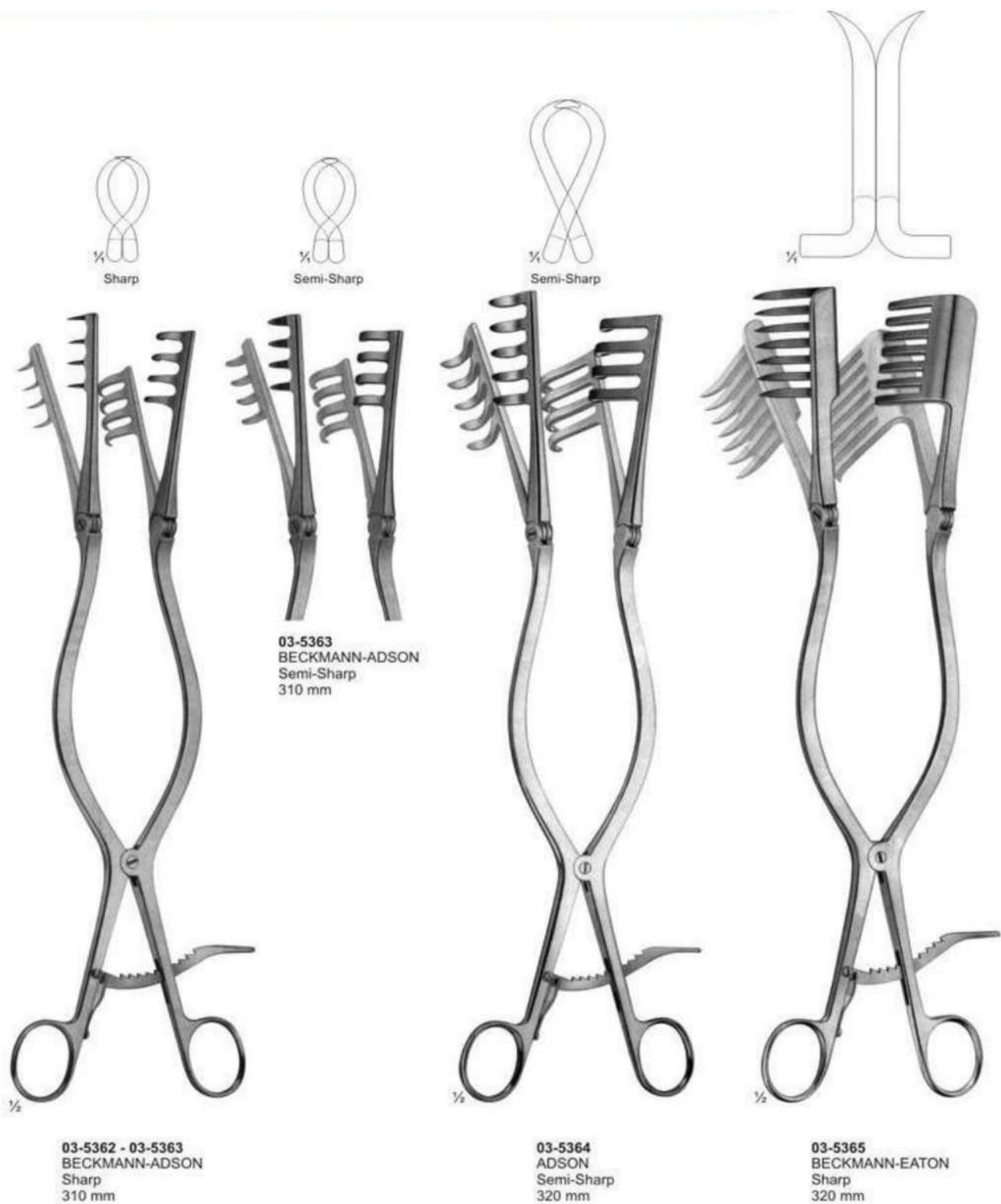



03-5366
JOLL (FRIEDMAN)
Thyroid- and Vaginal Retractor
155 mm



03-5367
JACKSON BURROWS
Retractor, blunt
185 mm



03-5368
GELPI
Vaginal Retractor
135 mm



03-5369
GELPI
Skin- and Vaginal Retractor
175 mm



03-5370
DE BAKEY
Femur Retractor
145 mm



03-5371
SCOVILLE-RICHTER
Retractor with 1 pair
blades reversible type.
The Retractor bar and shanks
may be easily rotated 180 when
blades are in situ.



03-5372
62 x 52 mm
PR= Pair

03-5373
62 x 37 mm



03-5373
47 x 51 mm



03-5374
30 x 40 mm



03-5375
37 x 62 mm



03-5376
CLOWARD modif.
Spreader Only
Consisting of:
Spreader Only
03-5377 1 Blade
03-5378 1 Blade
03-5379 1 Blade
03-5380 1 Blade
03-5381 1 Blade

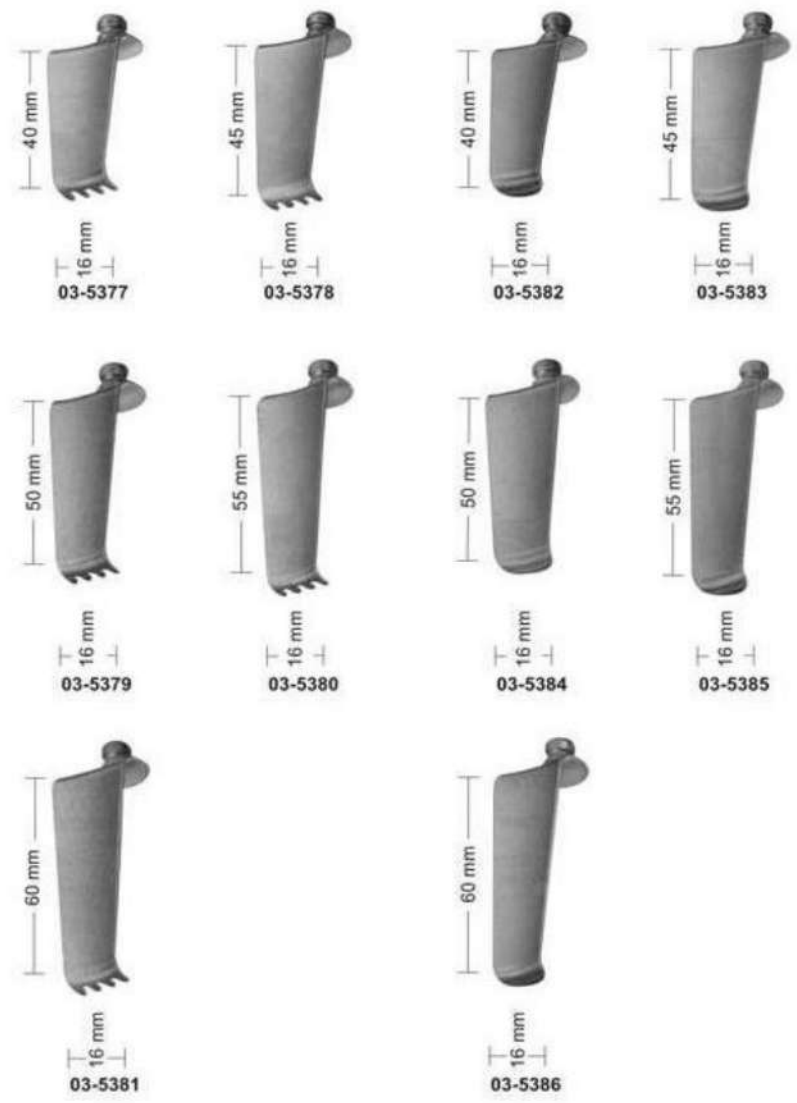

Blades only used for 03-5376



03-5387
CASPAR
Retractor, adjustable, consisting of:
5 medial blades (03-5389 - 03-5393) 5 Lateral
blades. (03-5394 - 03-5398) and the retractor
only By Reversing the Screw,
The Retractor Can be Used From Both Sides

To be used preferably for transverse retraction.



03-5388
CASPAR
Counter retractor, adjustable,
consisting of: 5 blades. (03-5399 - 03-5403)
and the retractor only

To be used preferably for
up and down retraction.



03-5389 40 x 23 mm
03-5390 45 x 23 mm
03-5391 50 x 23 mm
03-5392 55 x 23 mm
03-5393 60 x 23 mm
Medial blades

03-5394 40 x 23 mm
03-5395 45 x 23 mm
03-5396 50 x 23 mm
03-5397 55 x 23 mm
03-5398 60 x 23 mm
Lateral blades

03-5399 45 x 23 mm
03-5400 50 x 23 mm
03-5401 55 x 23 mm
03-5402 60 x 23 mm
03-5403 65 x 23 mm
Blunt blades

03-5404 50 x 25 mm
03-5405 60 x 25 mm
Blunt blades,
for harvesting of the
fusion graft from the
iliac crest

03-5406 40 x 25 mm
03-5407 45 x 25 mm
03-5408 50 x 25 mm
03-5409 55 x 25 mm
03-5410 60 x 25 mm
Medial Titan blades
semi transparent to x-ray

03-5411 40 x 25 mm
03-5412 45 x 25 mm
03-5413 50 x 25 mm
03-5414 55 x 25 mm
03-5415 60 x 25 mm
Lateral Titan blades
semi transparent to x-ray



03-5416
CLOWARD
155 mm



03-5417
CLOWARD
135 mm



03-5418
INGE
170 mm

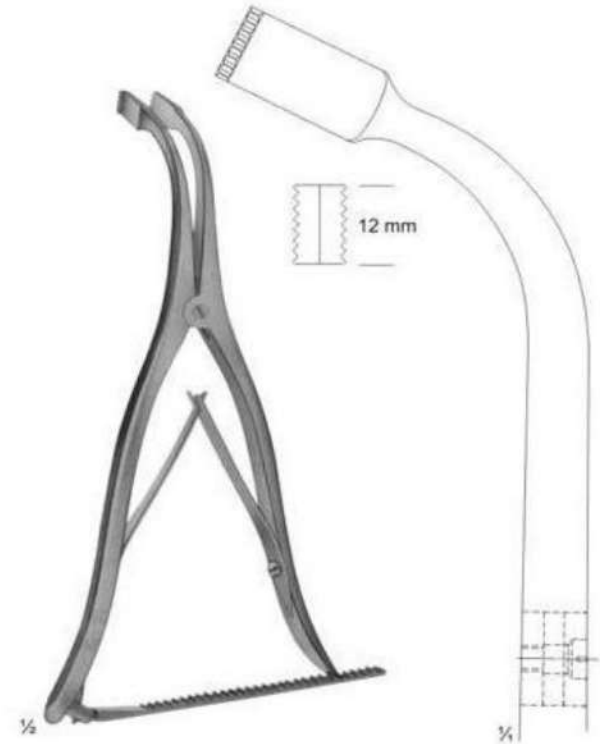

03-5419
INGE
275 mm

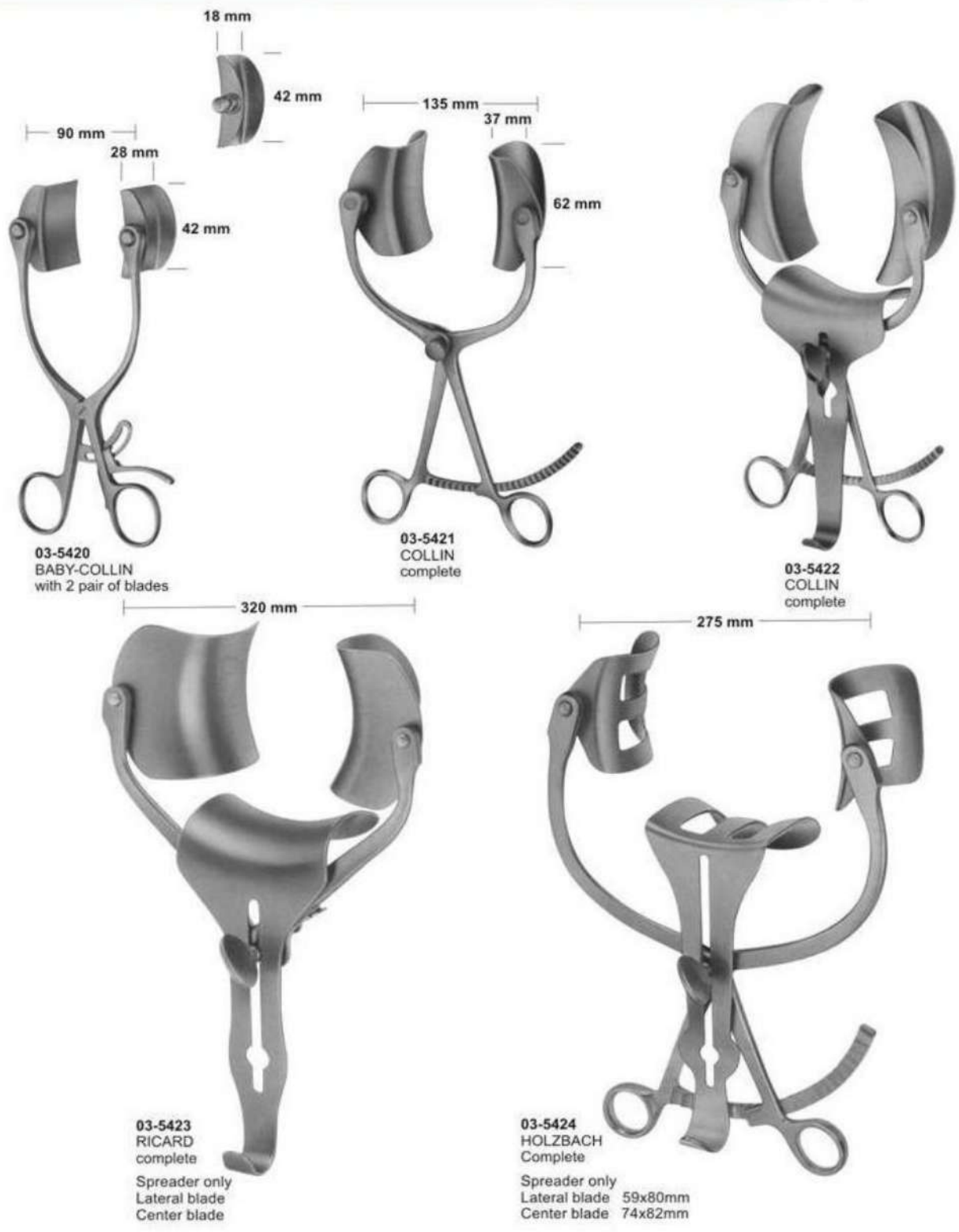



Lateral blades only
03-5425 37x62 mm
03-5426 37x80 mm
03-5427 37x98 mm

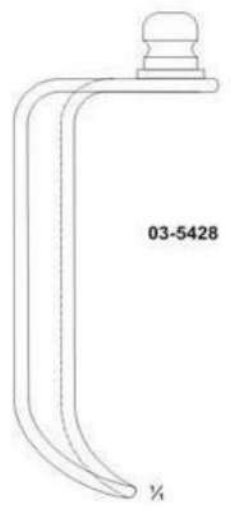

03-5428 61x80 mm

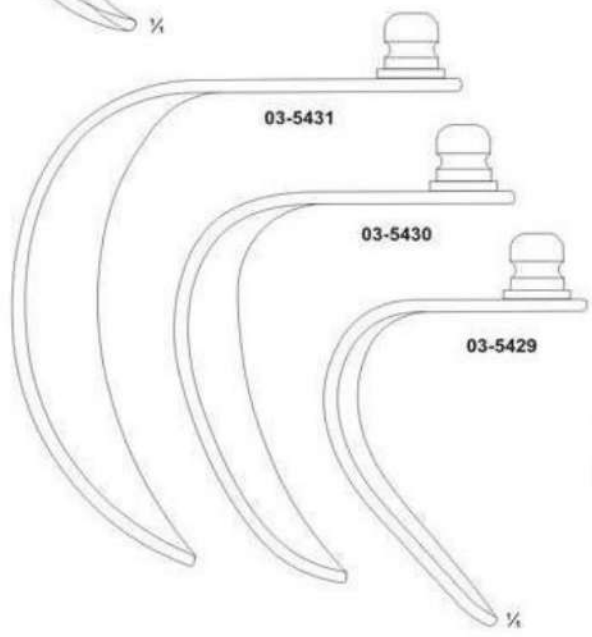

03-5429 48x59 mm
03-5430 58x80 mm
03-5431 72x84 mm





03-5433
GOSSET
Blades: 38 mm deep

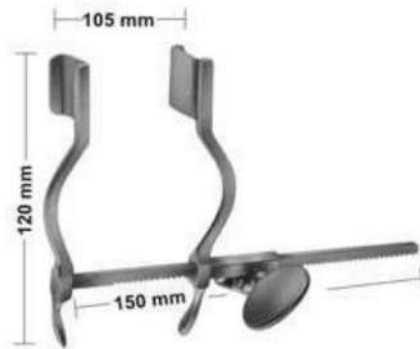

03-5434
HERTZLER
Blades 20 X 25 mm

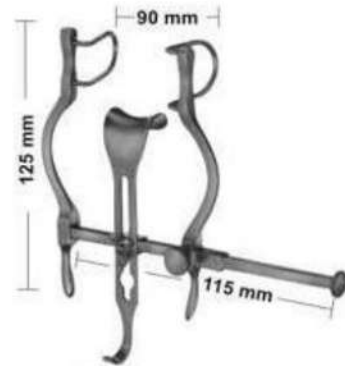

03-5435
BALFOUR-BABY
Lateral blades 27 mm deep
(03-5435) Center blade 21x24 mm

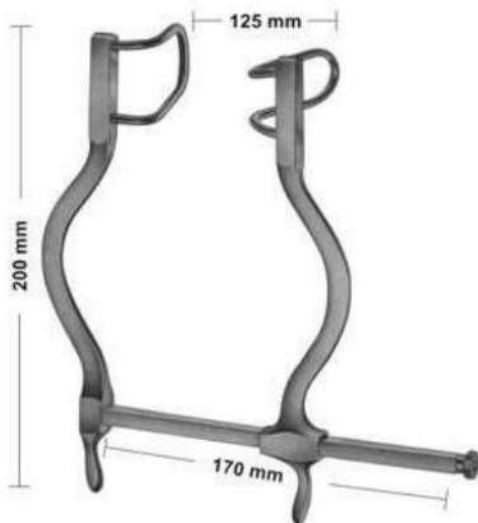

03-5436
GOSSET
Blades: 55 mm deep

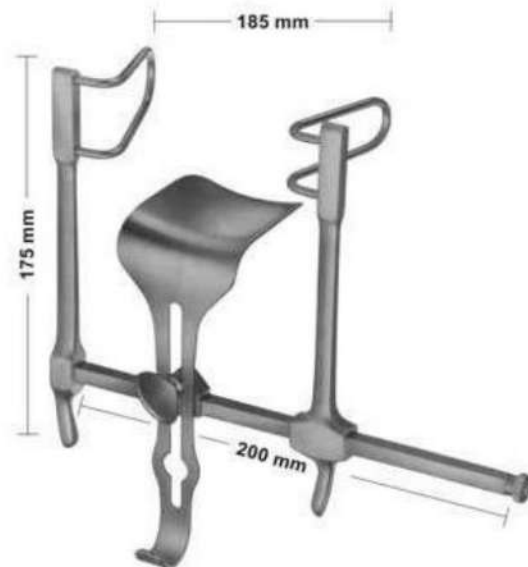

03-5437
GOSSET
Lateral blades 58 mm deep
Center blade
59 x 57 mm

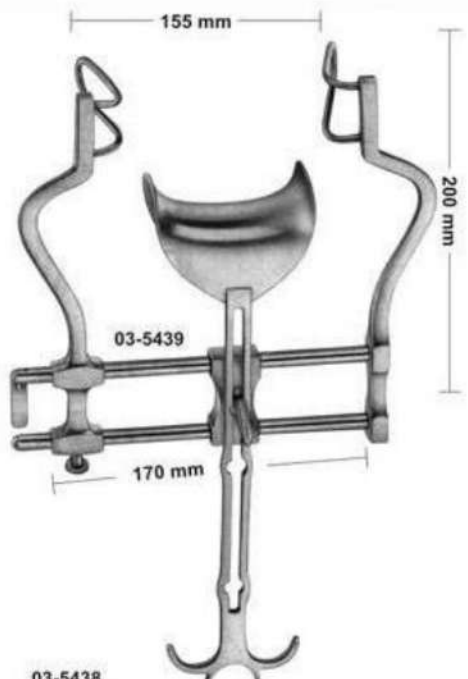

03-5438
BALFOUR
Lateral blades 60 mm deep
(03-5439) Center blade
47 x 80 mm

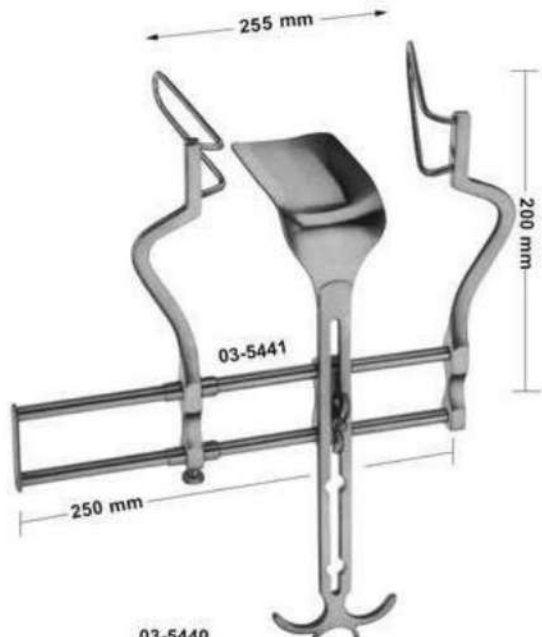

03-5440
BALFOUR
Lateral blades 105 mm deep
(03-5441) Center blade
107x 59 mm



03-5442
Center blade only
54x80 mm

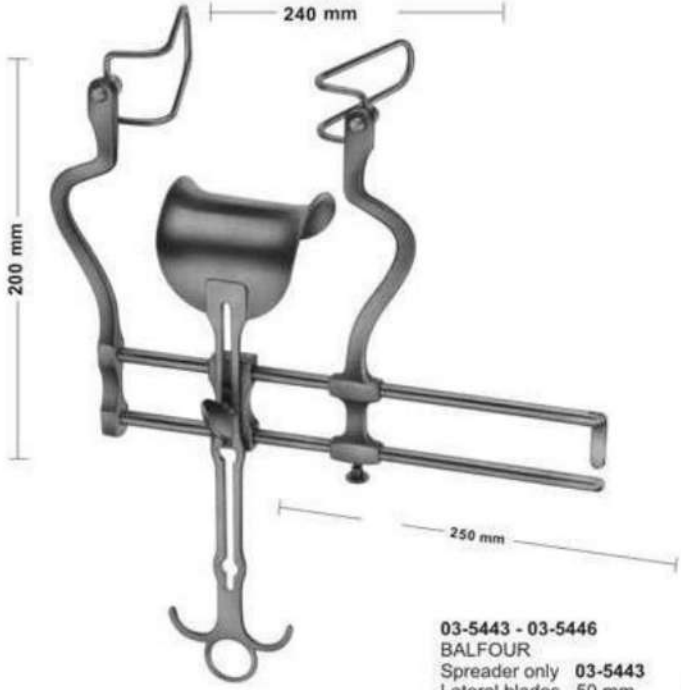

03-5443 - 03-5446
BALFOUR
Spreader only
Lateral blades 50 mm 60 mm 75 mm 90 mm
Center blade 47 x 80 mm 62x76 mm 80x80 mm 80x80 mm



Lateral blades
03-5447 50 mm deep
03-5448 60 mm deep
03-5449 75 mm deep
03-5450 90 mm deep
Sales Unit of blades:PR = pair

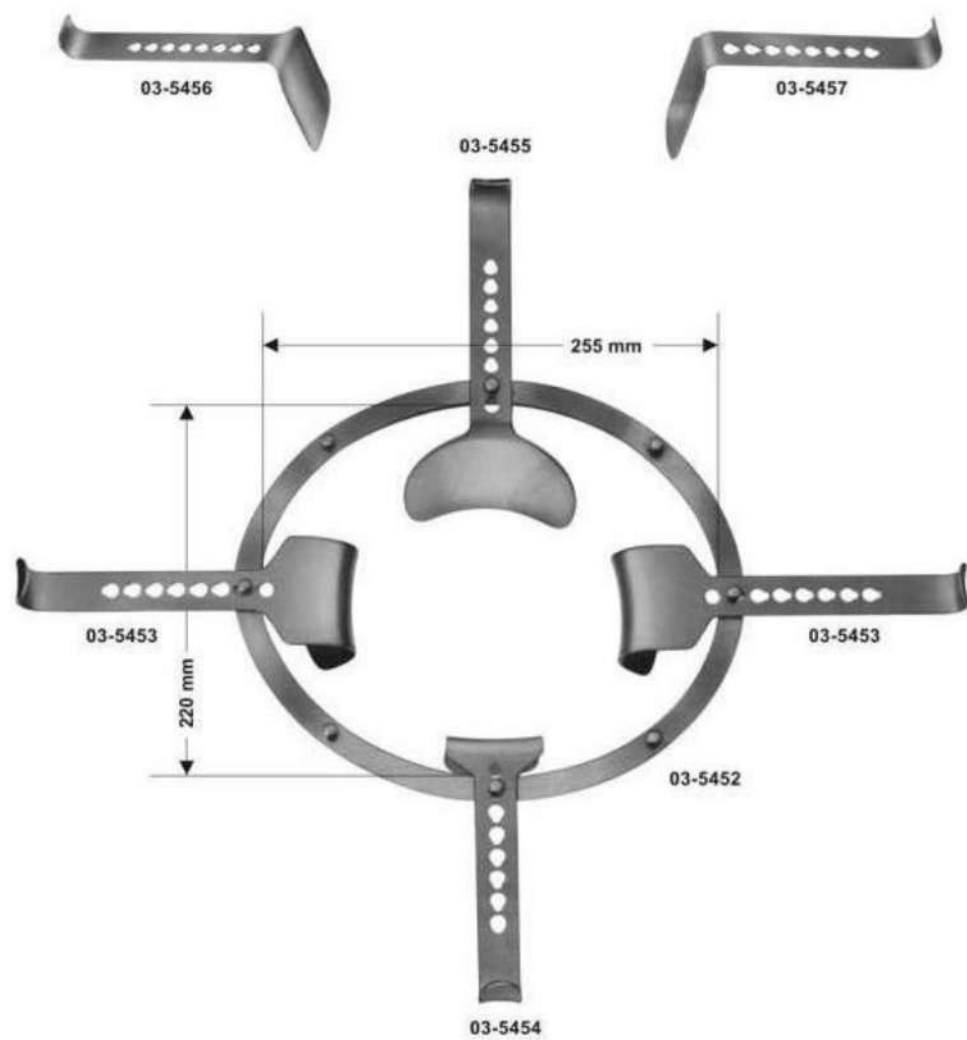

- 03-5451**
SEMM
consisting of:
- 03-5452** 1 frame 225 x 220 mm
 - 03-5453** 2 blades 46 x 64 mm
 - 03-5454** 1 blade 53 x 54 mm
(for bladder)
 - 03-5455** 1 blade 82 x 97 mm
(for intestine)
 - 03-5456** 1 blade 98 x 51 mm
(for intestine)
 - 03-5457** 1 blade, narrow
107 x 36 mm

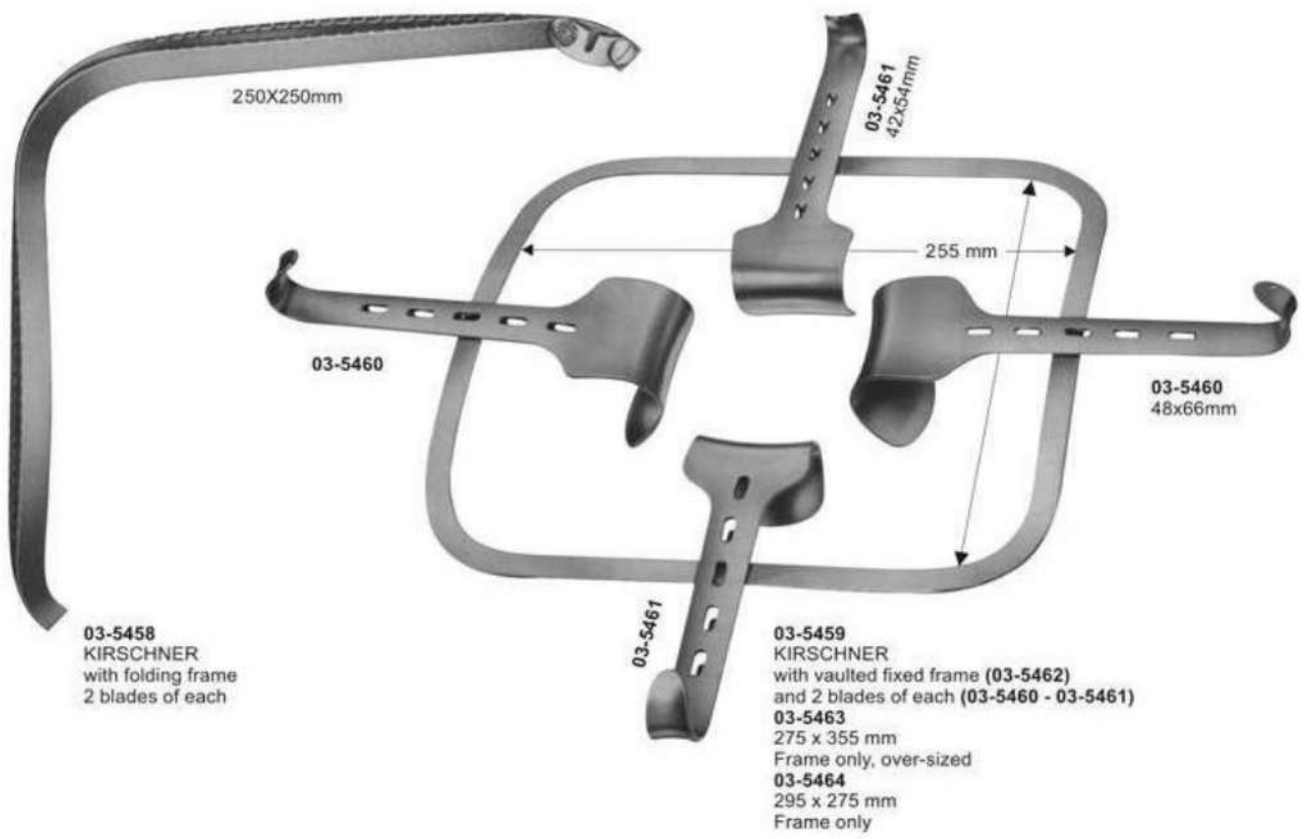

03-5465
KIRSCHNER
64 x 80 mm



03-5466
KIRSCHNER-BALFOUR
80x 82 mm



03-5467 - 03-5469
KIRSCHNER
03-5467 90x 69mm
03-5468 92x 95mm
03-5469 78x 58mm



03-5470 - 03-5472
KIRSCHNER
03-5470 108x42mm
03-5471 91x 55mm
03-5472 121x 55mm

Addition valves for corpulent persons.



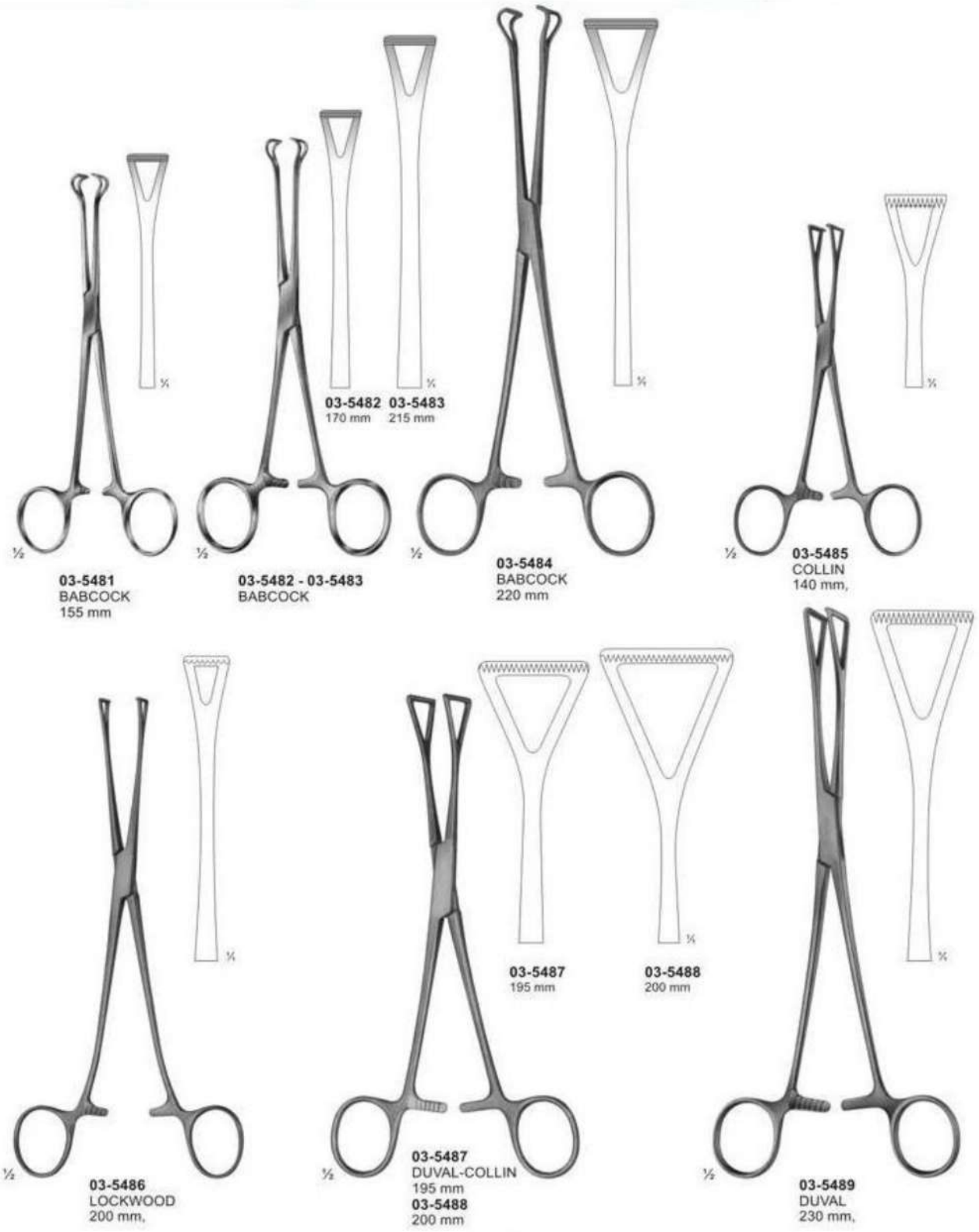



03-5490 130 mm
03-5491 155 mm
03-5492 195 mm

03-5490 - 03-5492
LANE

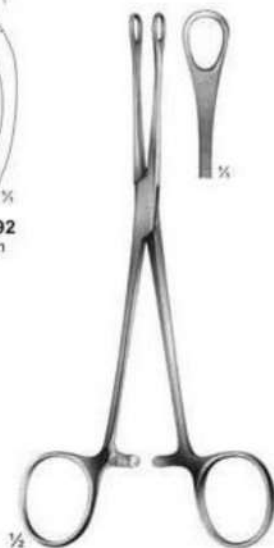

03-5493
WILLIAMS
160 mm



03-5494
DENIS
BROWNE
190 mm



03-5495
DUVAL
140 mm



03-5496 03-5497
DUROGRIP

03-5496 - 03-5497
WANGENSTEEN
03-5496 150 mm
03-5497 230 mm

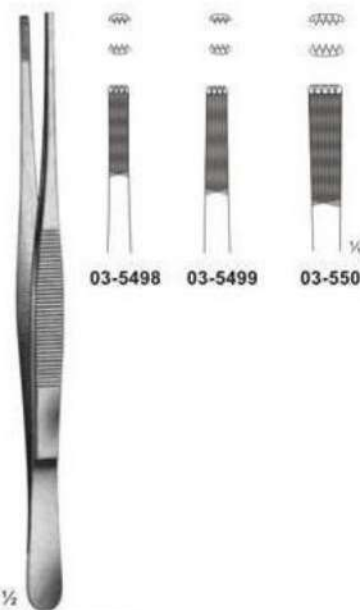

03-5498 - 03-5500
STILLE-BARRAYA
03-5498 180mm
03-5499 200mm
03-5500 250mm

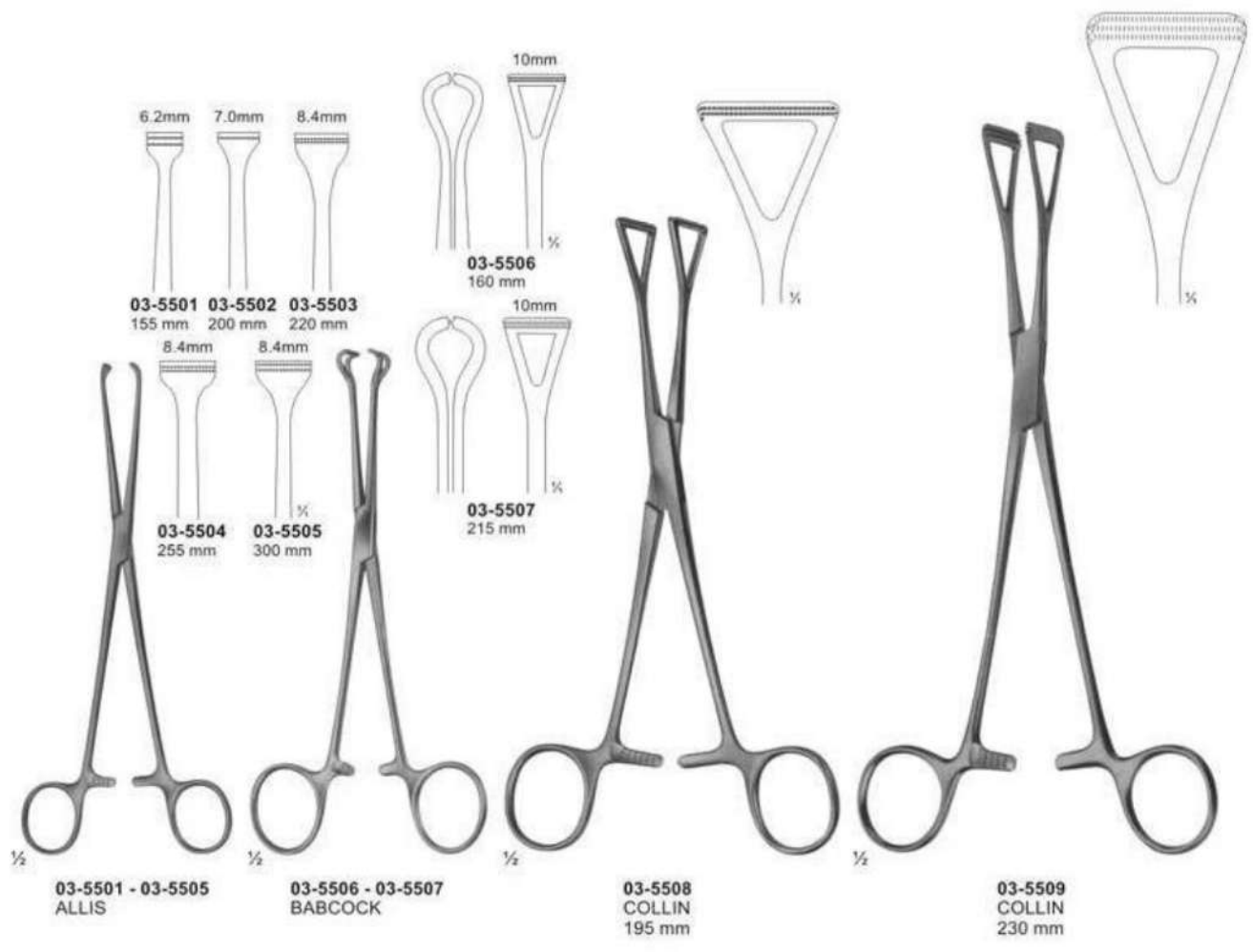

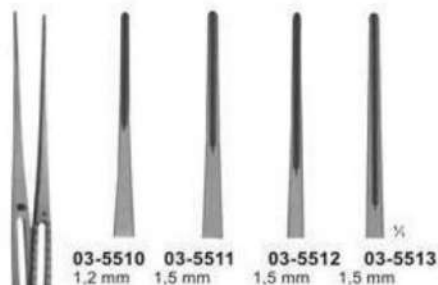

03-5510 - 03-5513
03-5510 150 mm
03-5511 200 mm
03-5512 240 mm
03-5513 300 mm



03-5514 - 03-5517
DE BAKEY
03-5514 150 mm
03-5515 200 mm
03-5516 240 mm
03-5517 300 mm

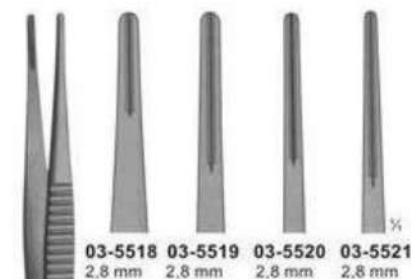

03-5518 - 03-5521
DE BAKEY
03-5518 150 mm
03-5519 200 mm
03-5520 240 mm
03-5521 300 mm



03-5522 - 03-5524
DE BAKEY
03-5522 200 mm
03-5523 240 mm
03-5524 300 mm



03-5525 - 03-5526
BAINBRIDGE
155 mm



03-5527
ALLEN
155 mm

Atraumata



03-5528 - 03-5529
BABY-KOCHER
very elastic blades
130 mm



03-5530 - 03-5531
BABY-KOCHER
with elastic blades
130 mm



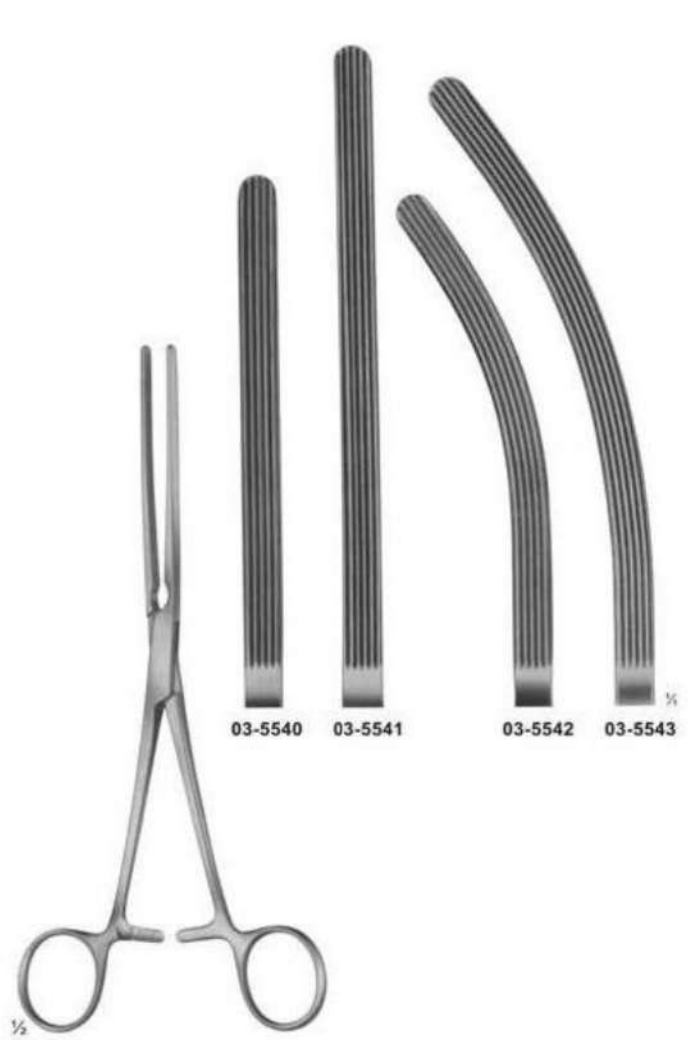

03-5540 - 03-5543
 KOCHER
 with elastic blades
 03-5540-03-5542 210 mm
 03-5541-03-5543 230 mm

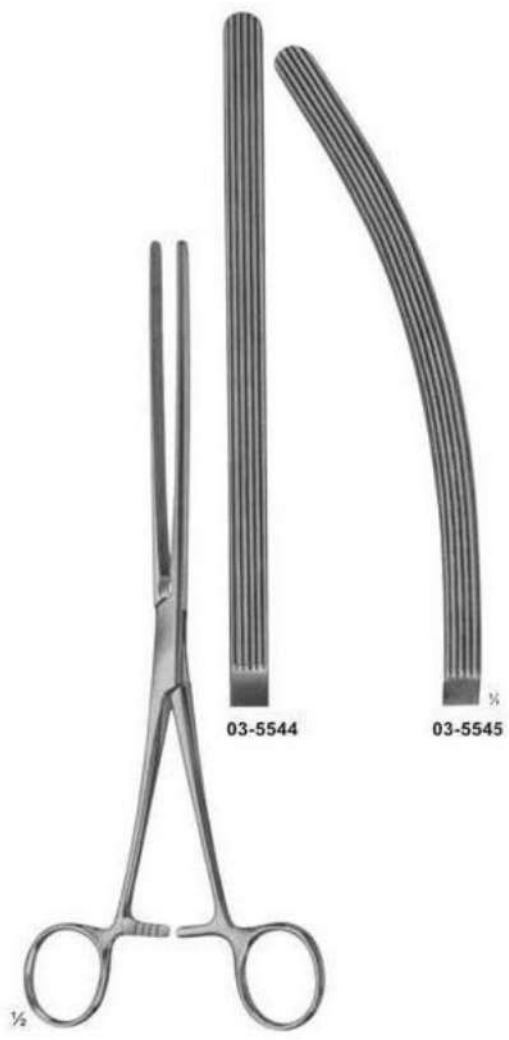

03-5544 - 03-5545
 DOYEN
 with elastic blades
 240 mm

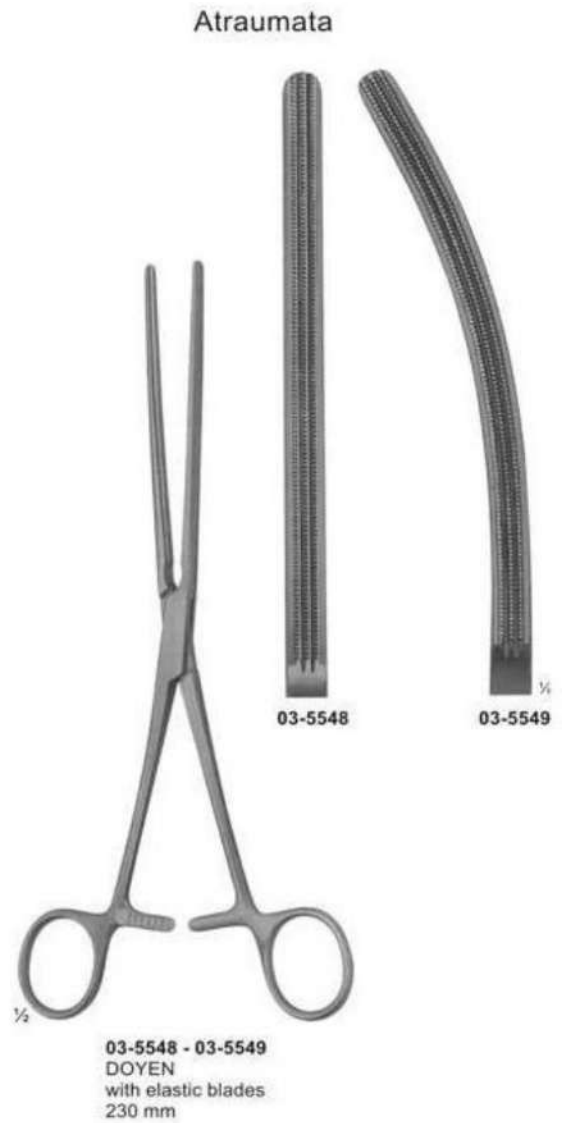
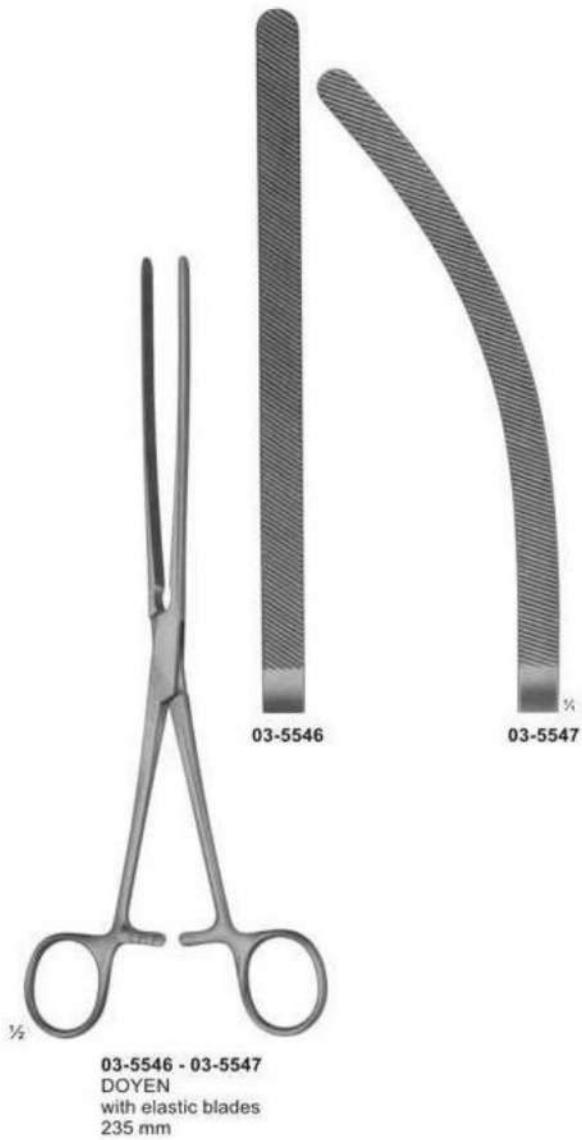

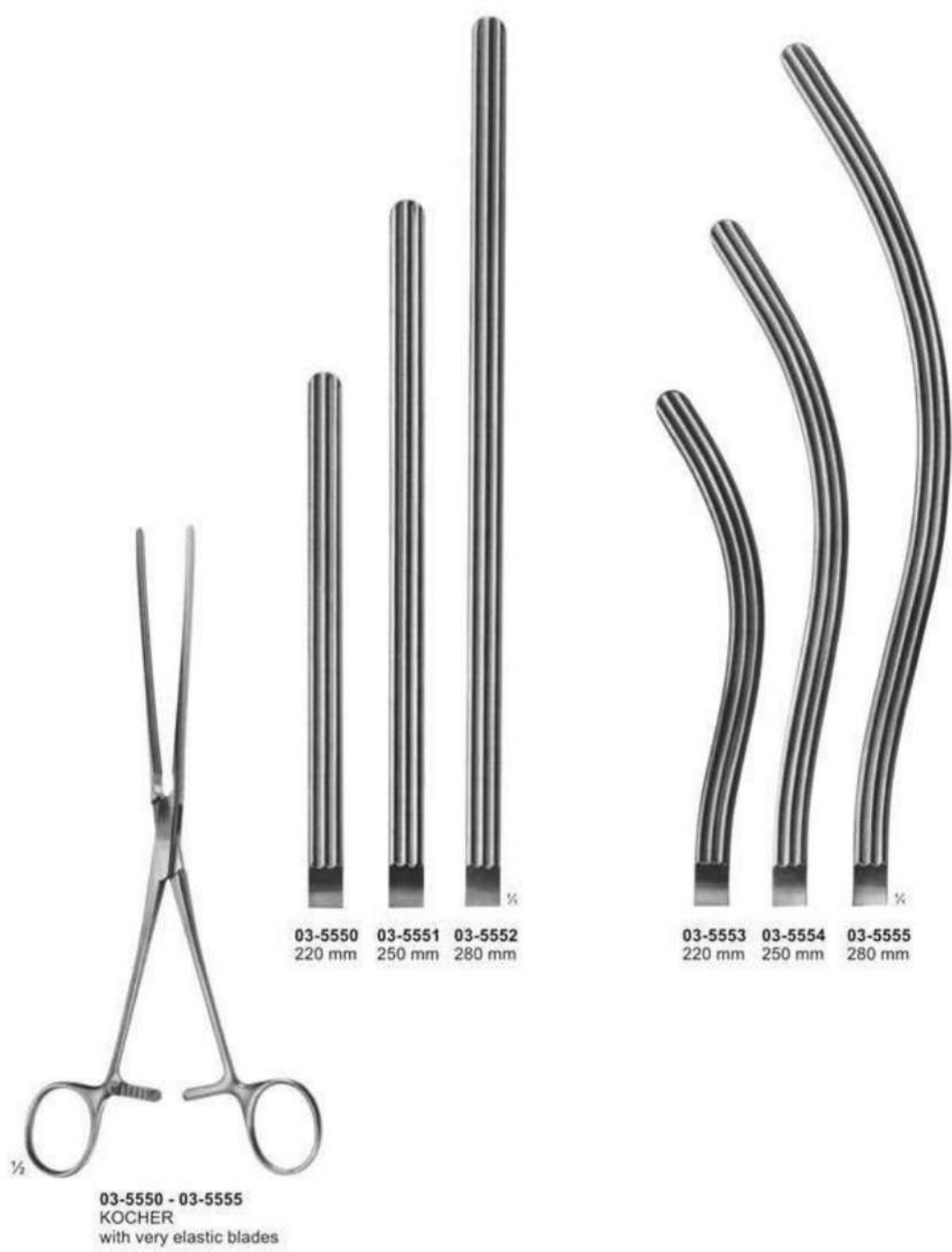

Atraumata

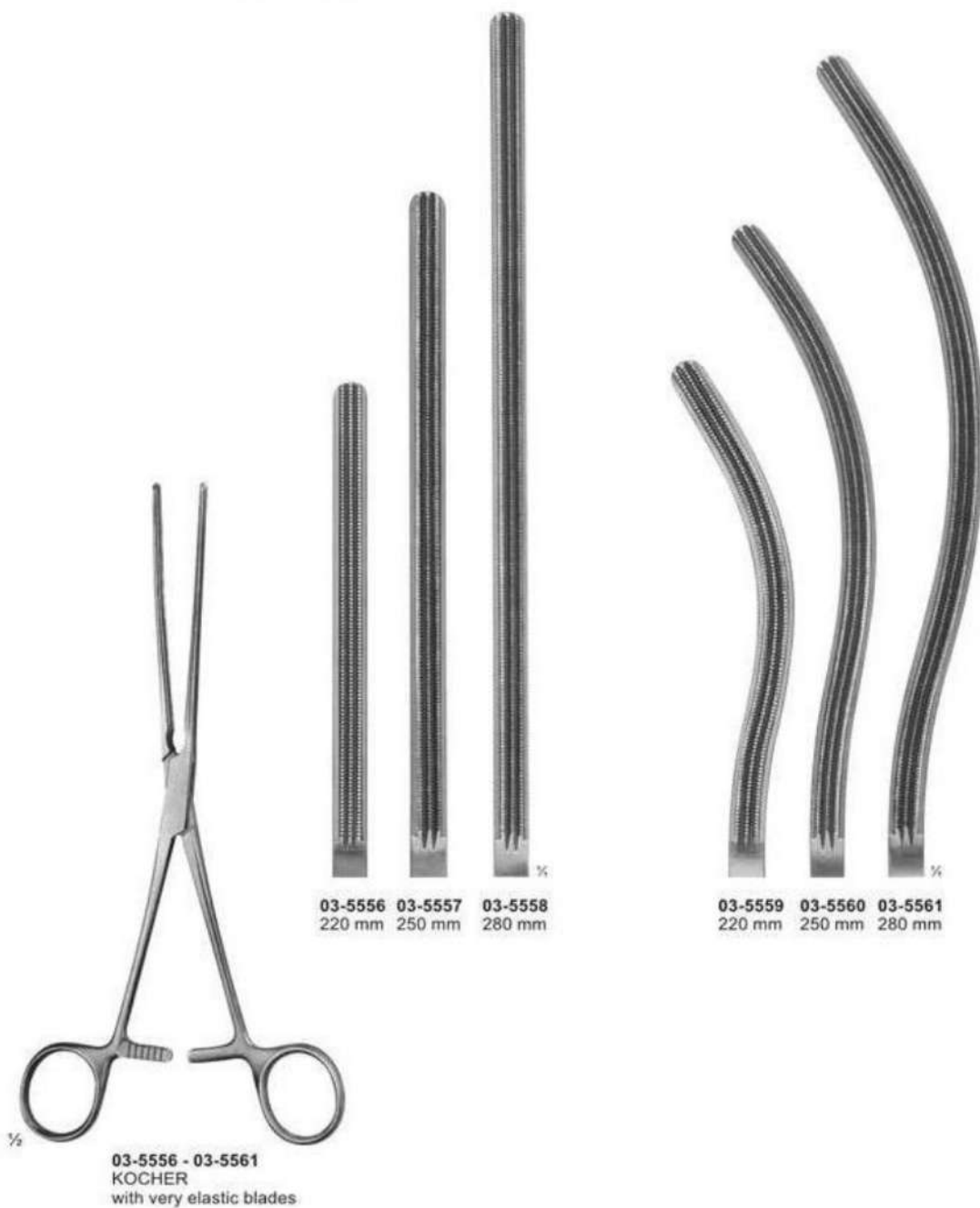

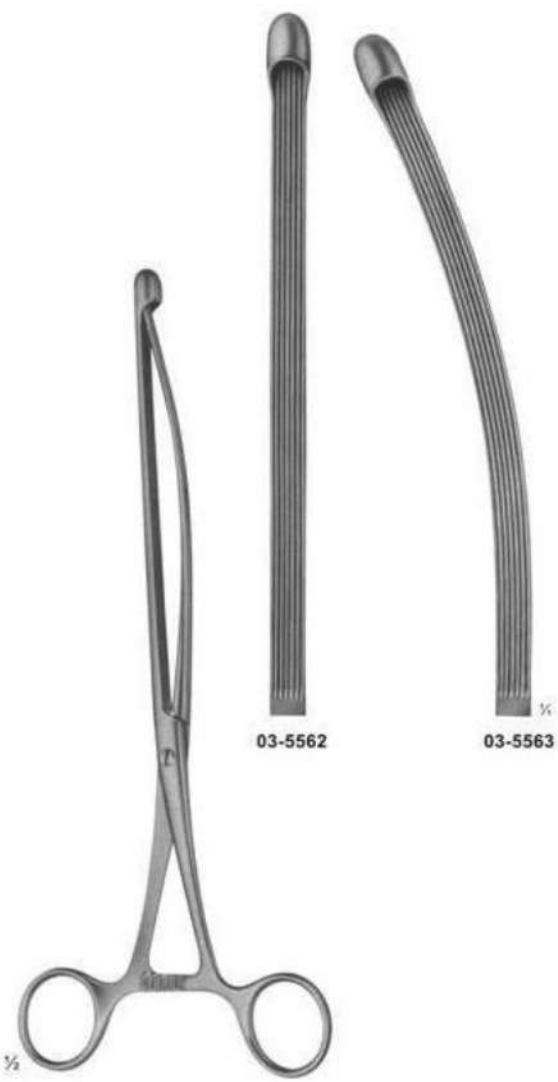

03-5562 - 03-5563
NUSSBAUM
with elastic blades
250 mm



03-5564
MOYNIHAN
280 mm

Atraumata

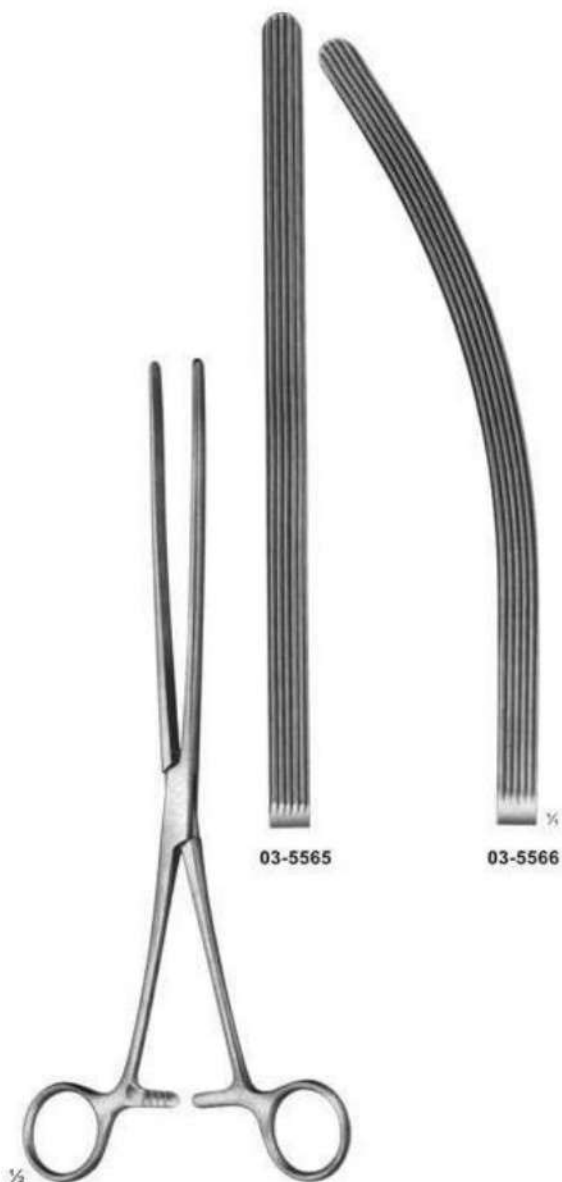

03-5565 - 03-5566
MAYO-ROBSON
hard elastic
250 mm

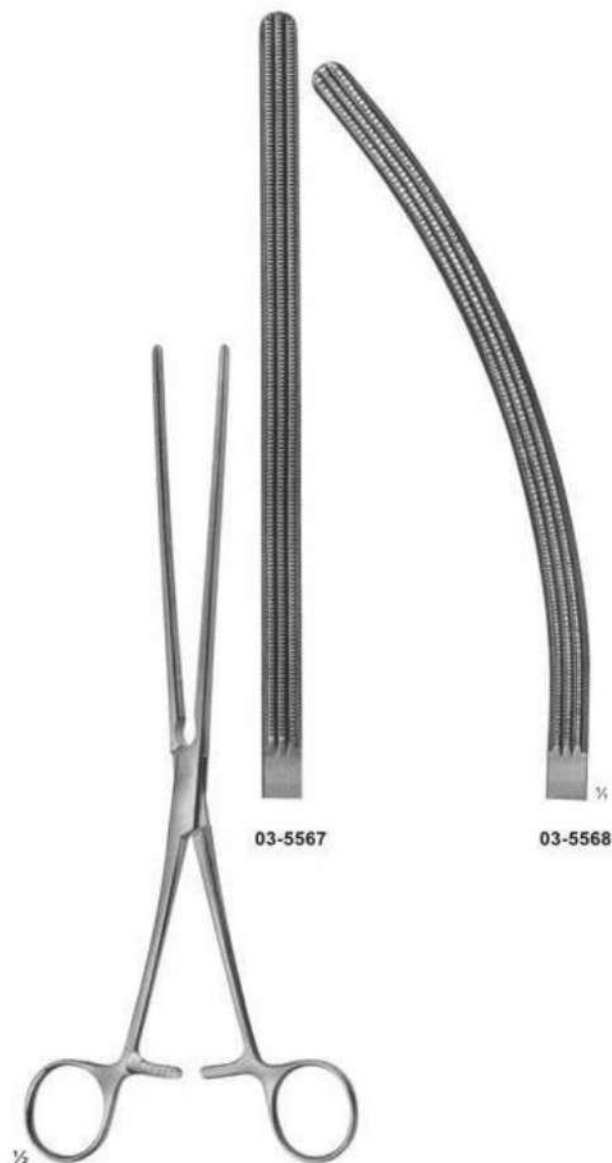

03-5567 - 03-5568
MAYO-ROBSON
250 mm



03-5569
LANE
300 mm

03-5570
LANE
300 mm

Atraumata

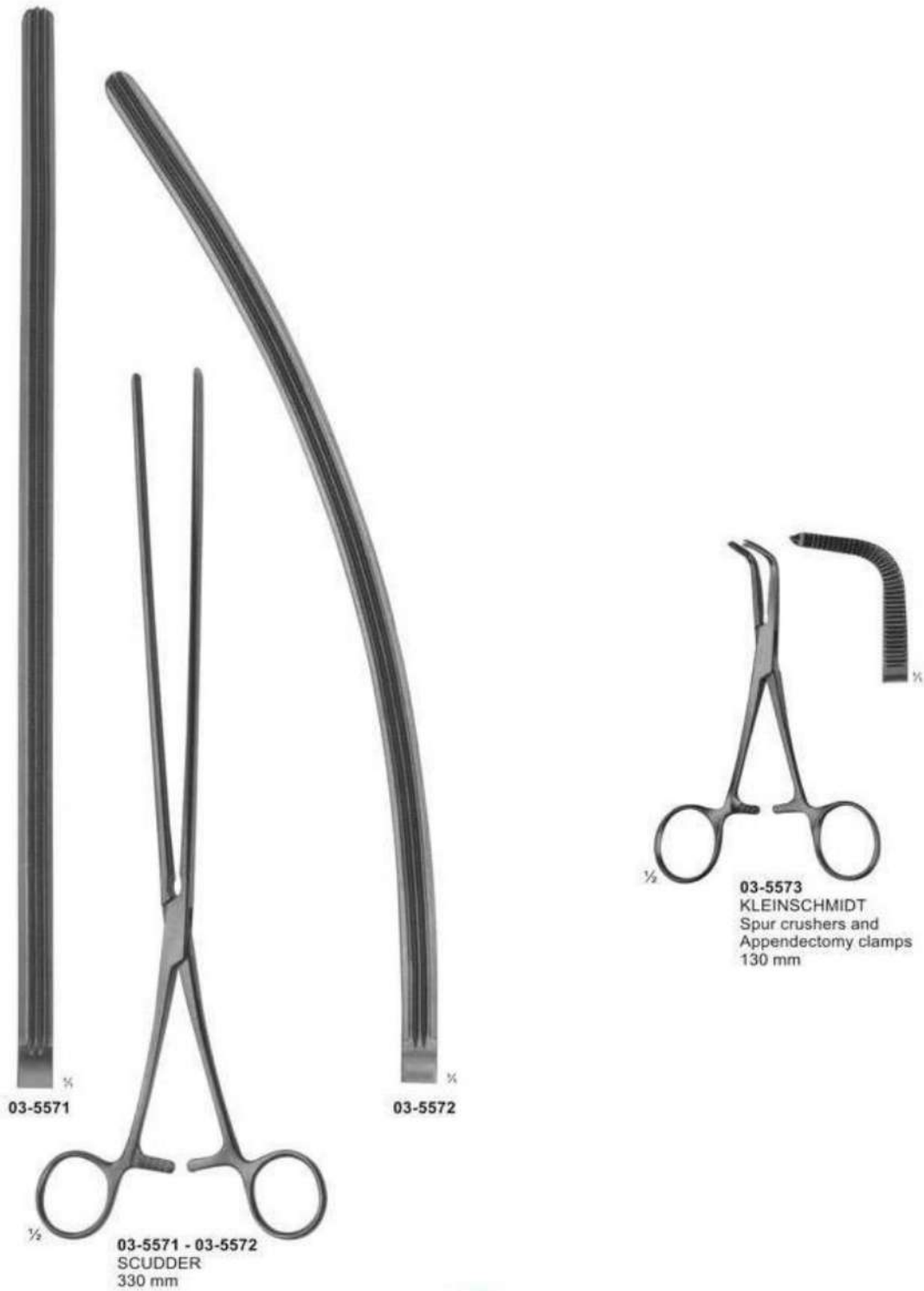



03-5574
PAYR
Intestinal clamp
light pattern,
for children
180 mm

03-5575
PAYR
200 mm

03-5576
PAYR
275 mm

03-5577
PAYR
Pylorus clamp
315 mm

Atraumata



03-5578
PARKER-KERR
anastomosis forceps
for colon resection
250 mm

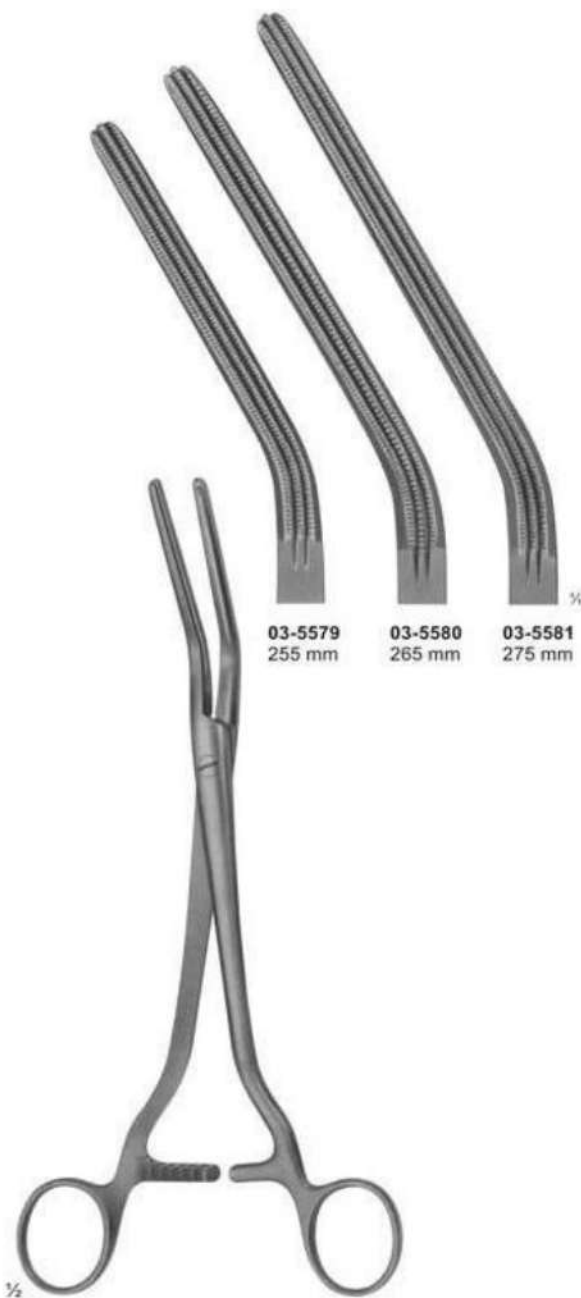

03-5579 - 03-5581
DICK
pressure clamps



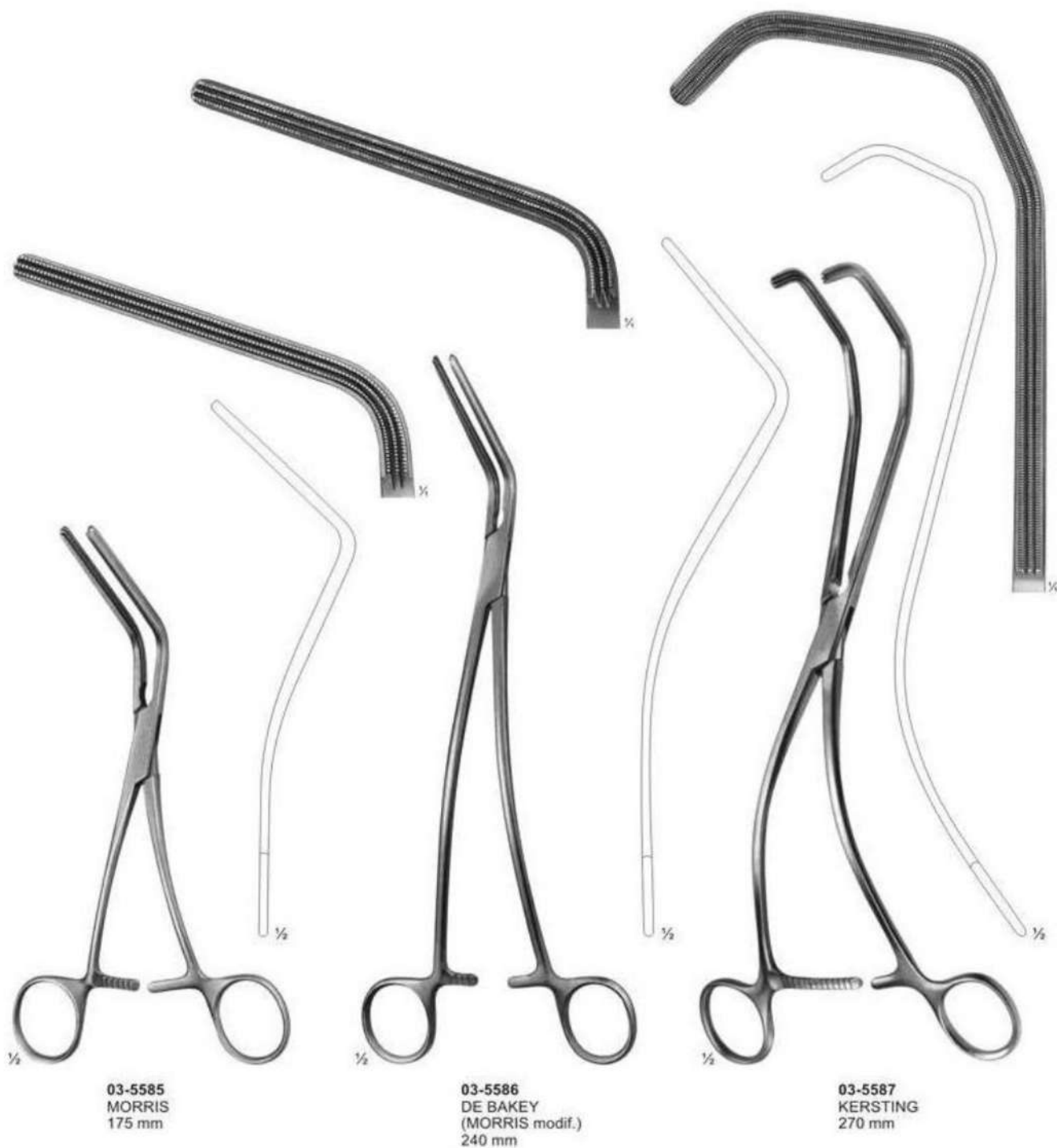



03-5588
KILLIAN
for children
145 mm



03-5589
SIMS
160 mm



03-5590
SIMS
160 mm

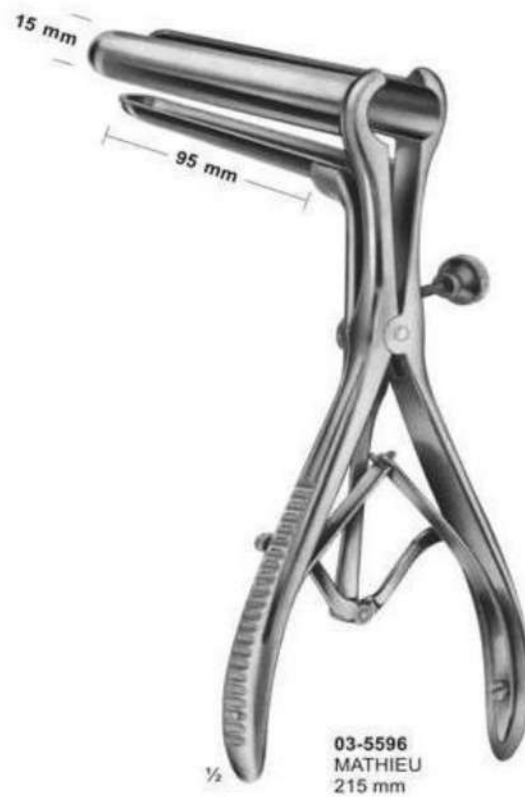
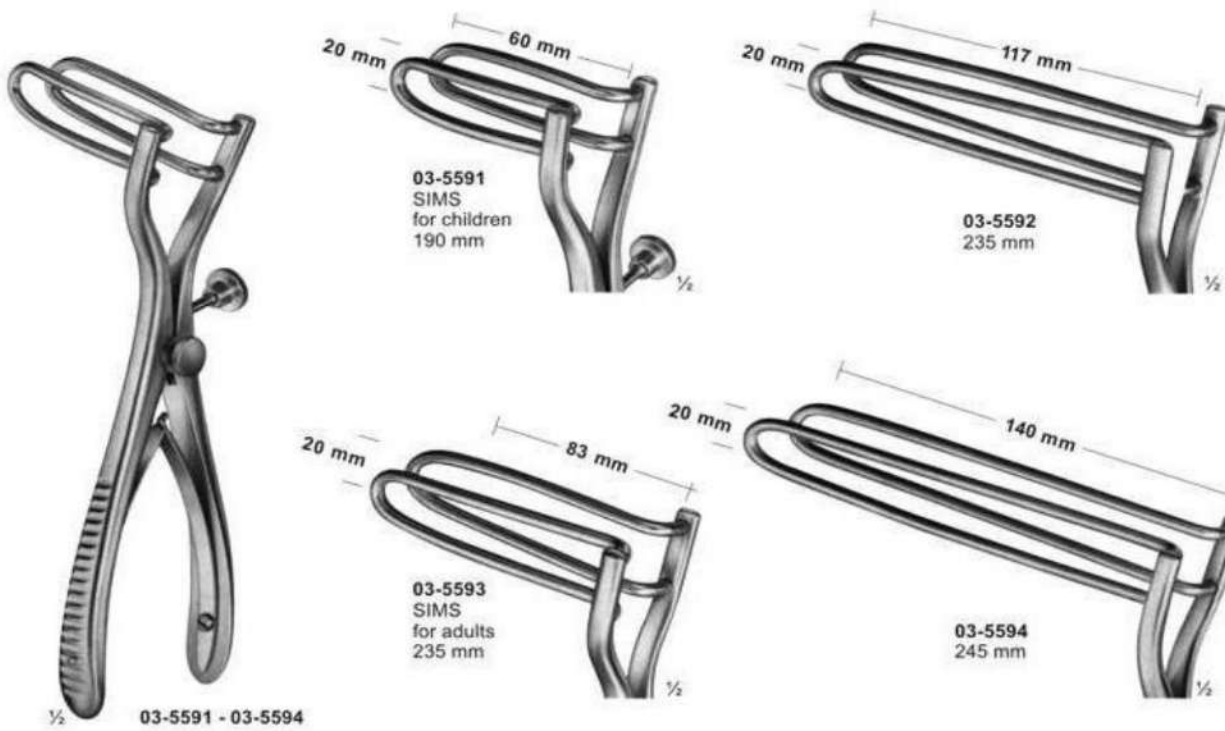



03-5597 IVES-FANSLER Anuscope 145 mm ø 24mm



03-5598 KELLY Sphincteroscope 160 mm ø 21mm



03-5599 KELLY Sphincteroscope 160 mm ø 27mm

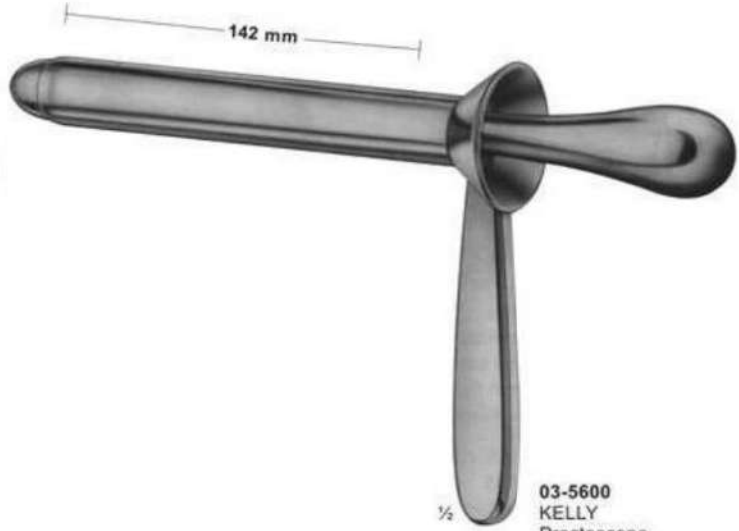

03-5600 KELLY Proctoscope 140 mm ø 22mm

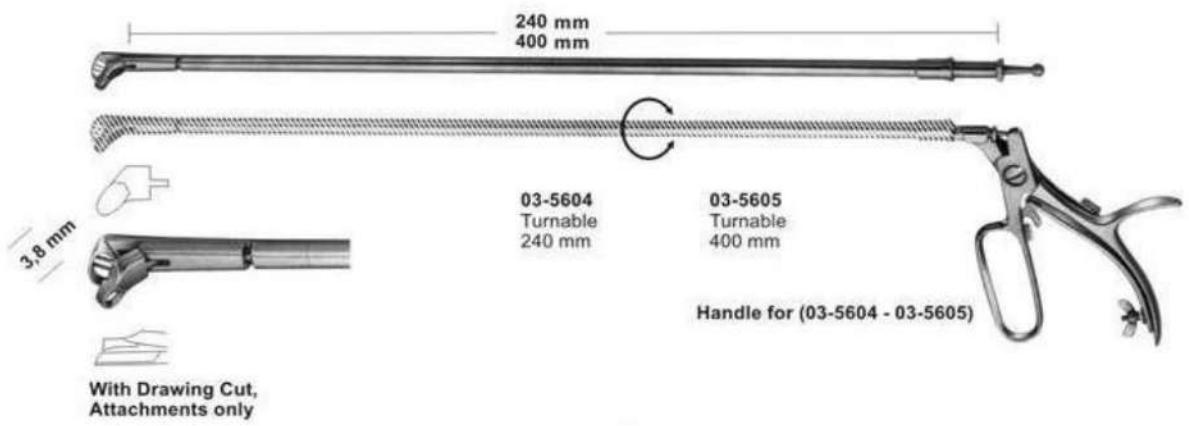
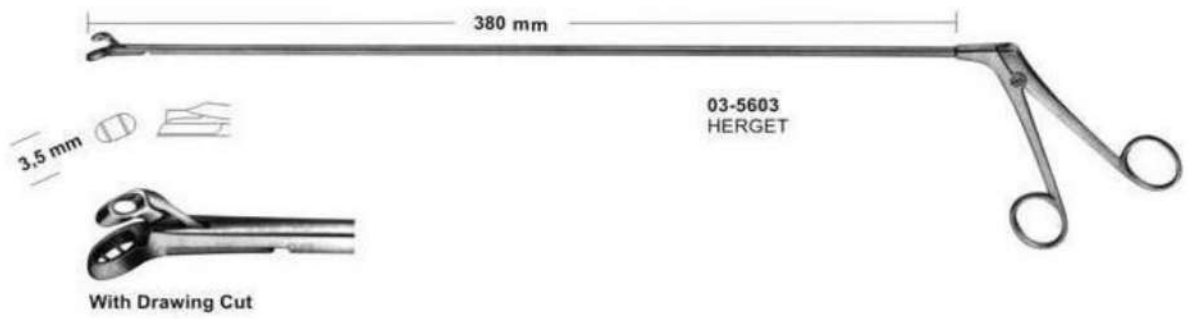
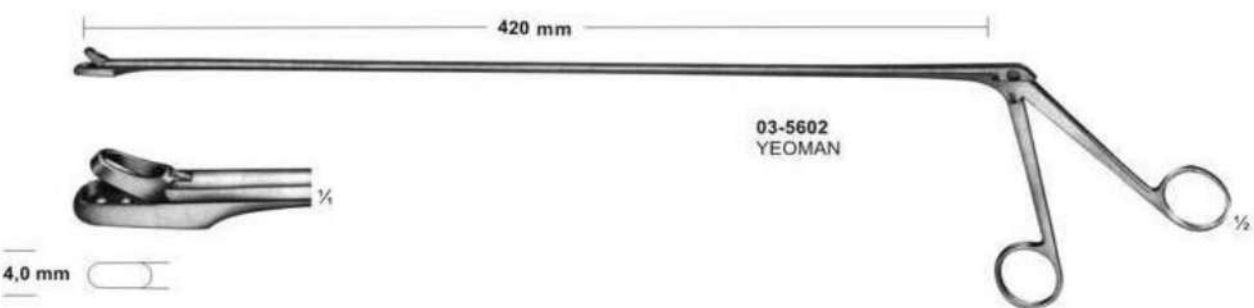
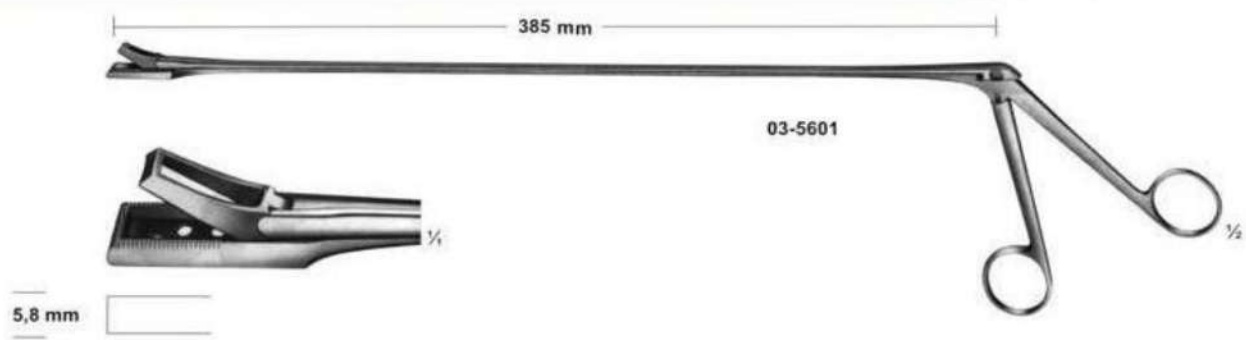

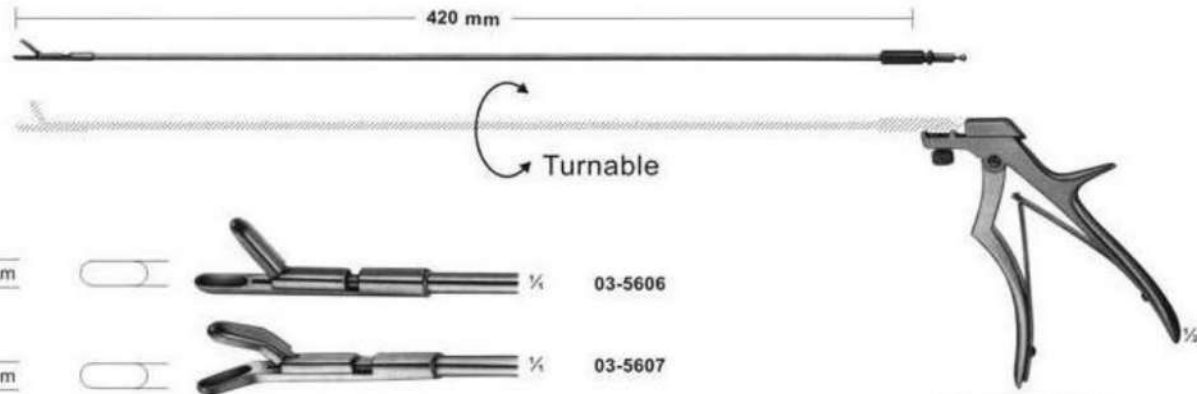

- | | | | | |
|--------|---|---|---|---------|
| 3,5 mm |  |  | ¼ | 03-5606 |
| 3,5 mm |  |  | ¼ | 03-5607 |
| 4,0 mm |  |  | ¼ | 03-5608 |
| 4,0 mm |  |  | ¼ | 03-5609 |

Biopsy Forceps 03-5606 - 03-5609
Handle for

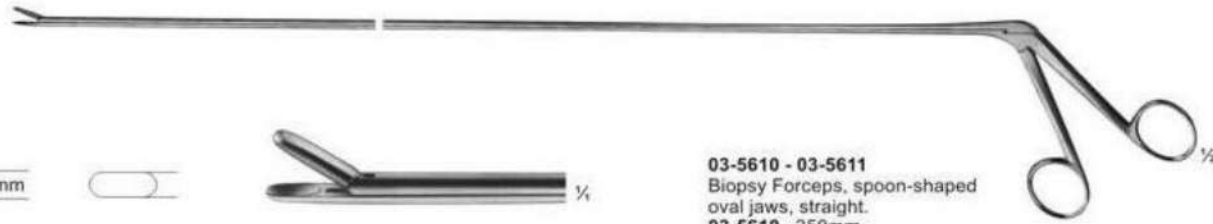

- | | | | |
|--------|---|---|---|
| 3,5 mm |  |  | ¼ |
|--------|---|---|---|

03-5610 - 03-5611
Biopsy Forceps, spoon-shaped
oval jaws, straight.
03-5610 350mm
03-5611 500mm

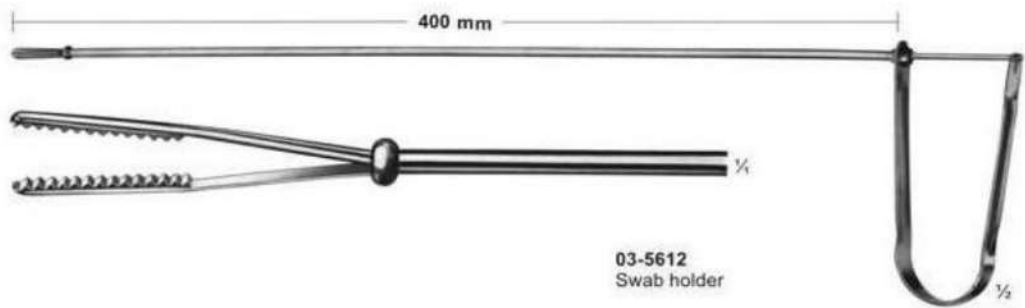

03-5612
Swab holder

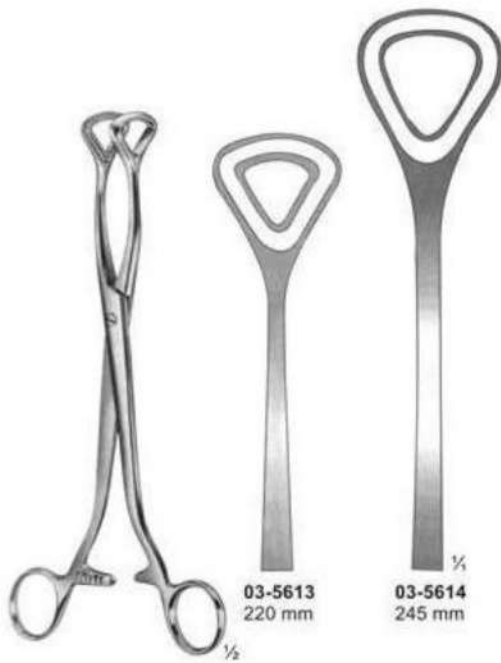

03-5613 - 03-5614
LUER

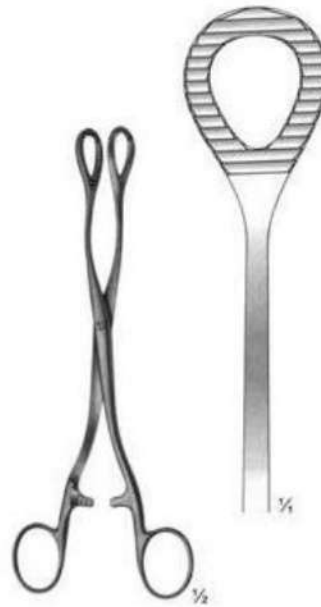

03-5615
HEYWOOD-SMITH
200 mm



03-5616
HEYWOOD-SMITH
modif
215 mm

Atraumata

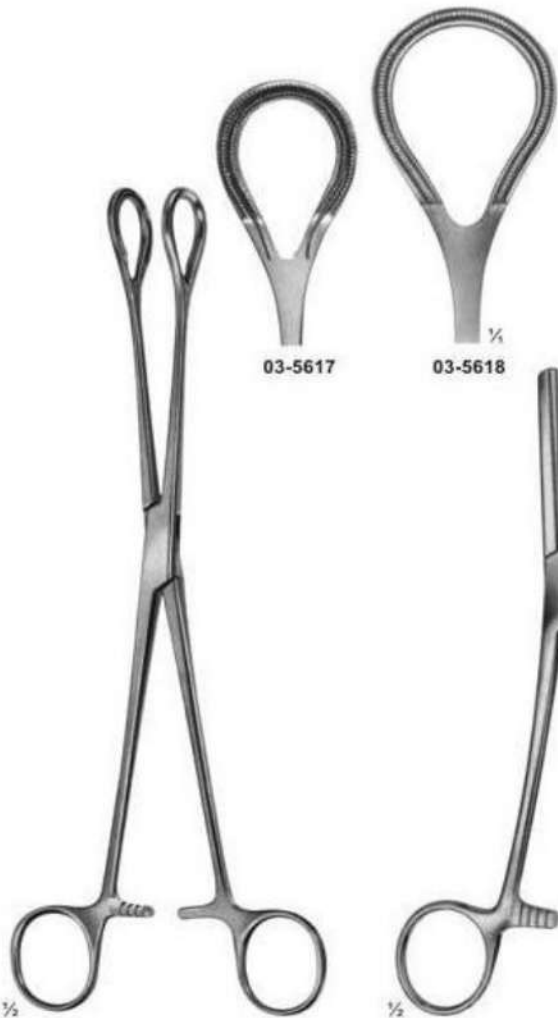

03-5617
250 mm
03-5618
270 mm

Pressure Clamp

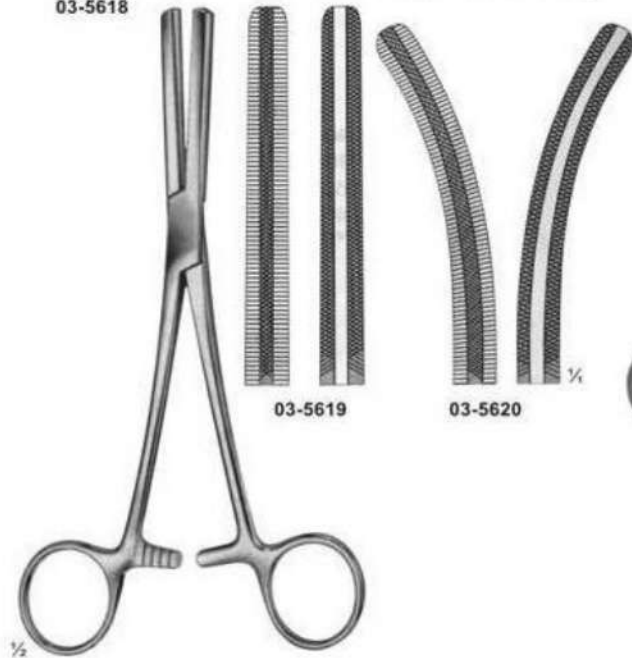

03-5619 - 03-5620
FERGUSSON
200 mm



03-5621
RUDD
Haemorrhoidal ligator
with loading
attachment and 100
ligature rubber rings
315 mm

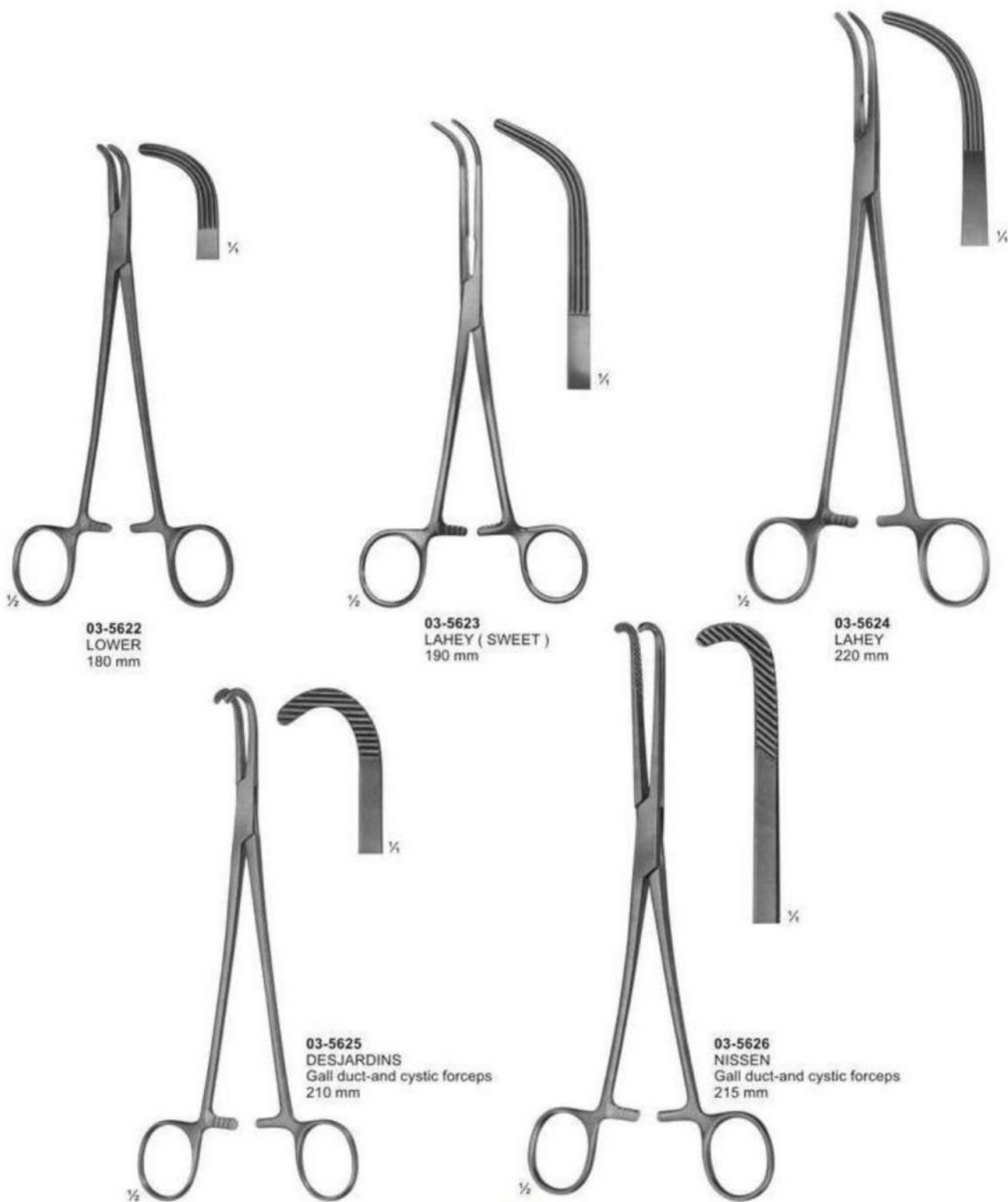

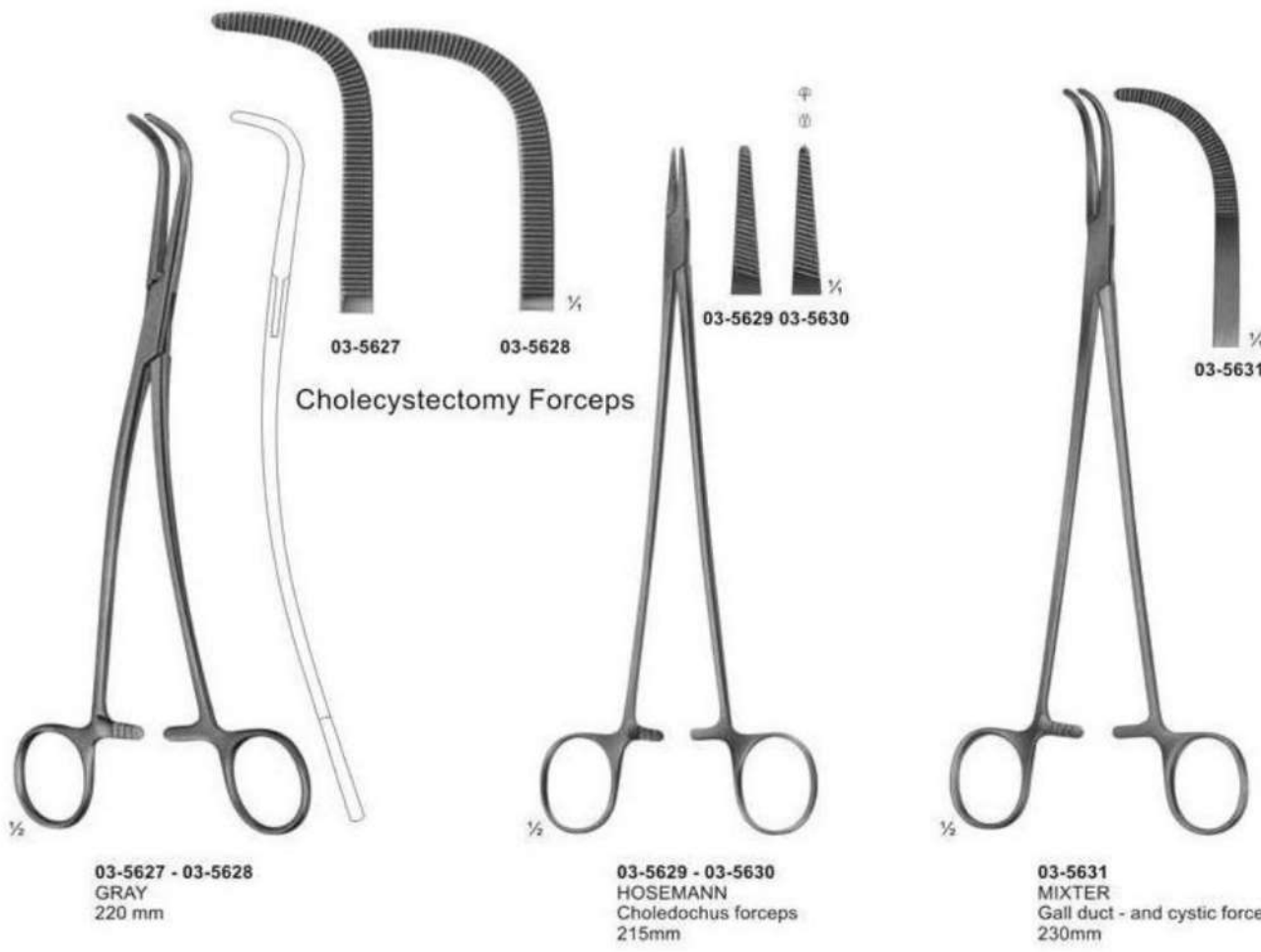

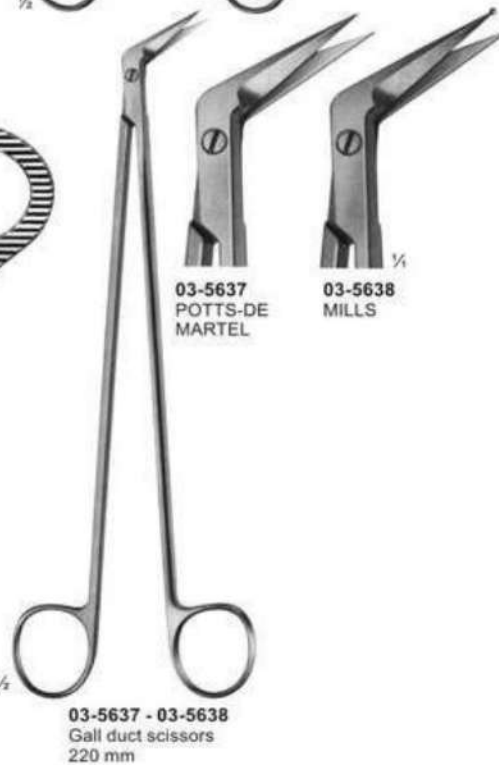
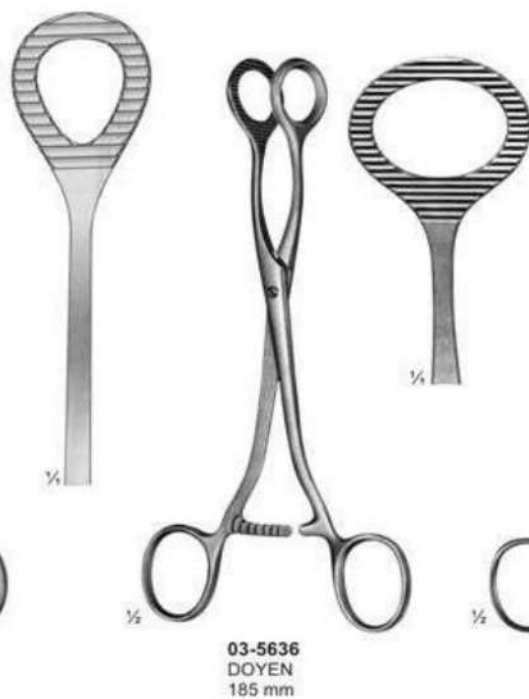
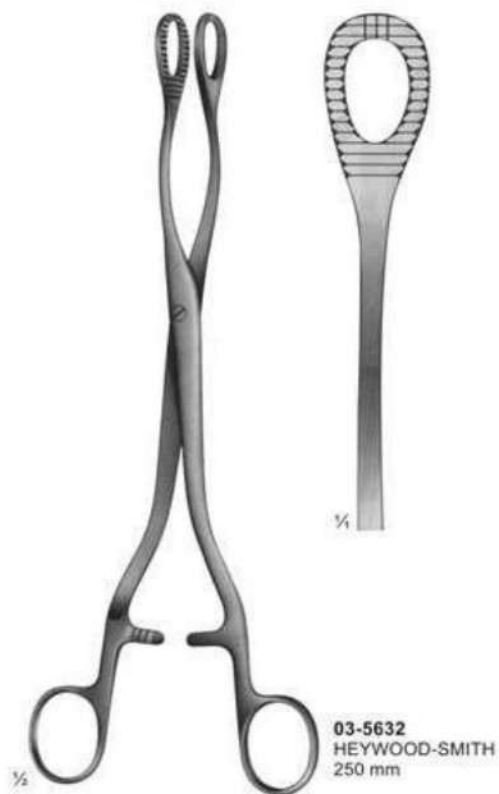

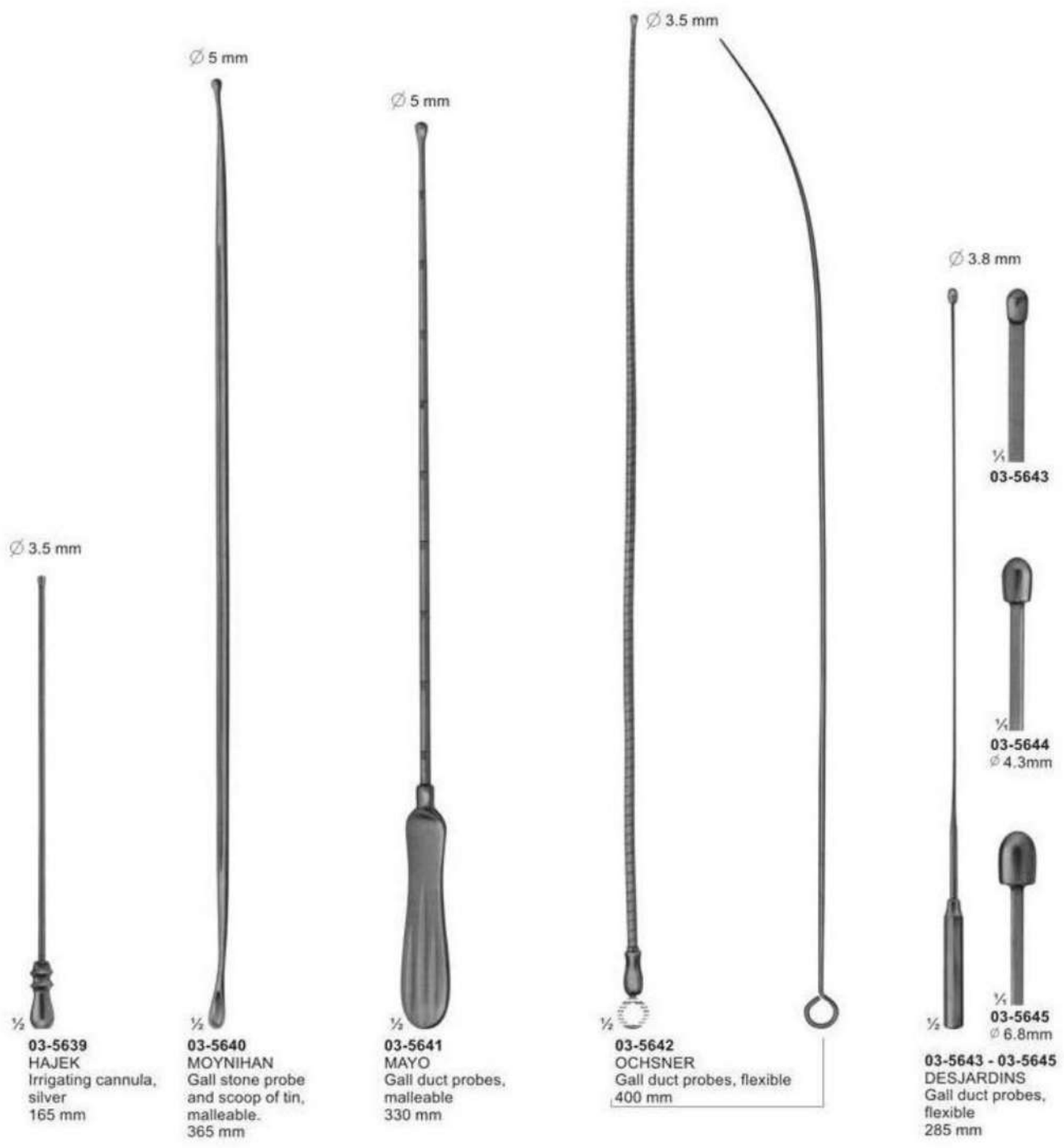

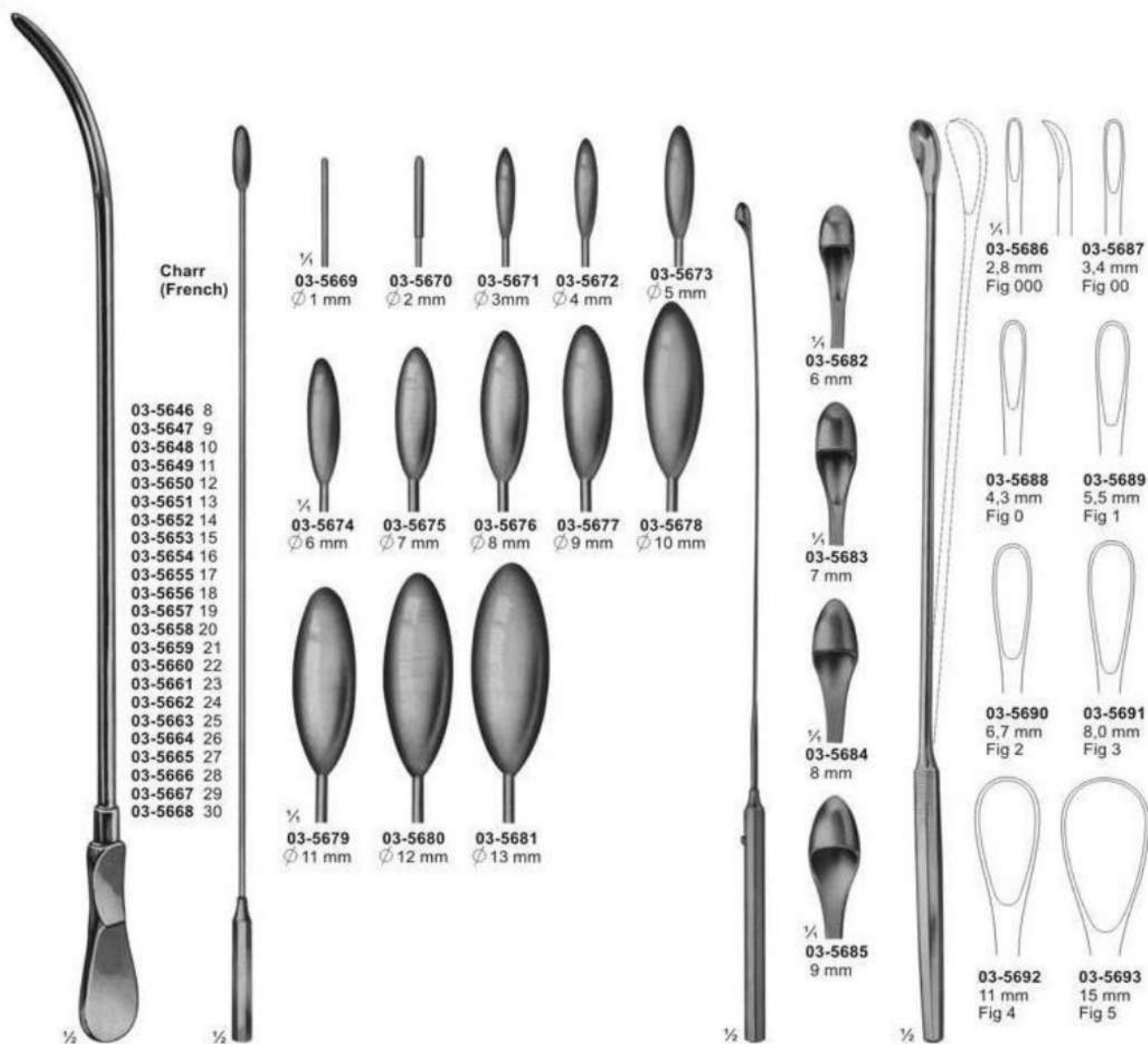

03-5646 - 03-5668
DITTEL
Metal bougies and dilating sounds, stiff 345 mm

03-5669 - 03-5681
BAKES
Common bile duct dilators, malleable
03-5669-03-5673 315mm
03-5674-03-5681 320mm
Set of 9 pieces (03-5671-03-5679) in canvas roll

03-5682 - 03-5685
DESJARDINS
Probes and catch with flexible shaft 300 mm

03-5686 - 03-5693
LUER-KOERTE
modif with malleable shaft 310 mm

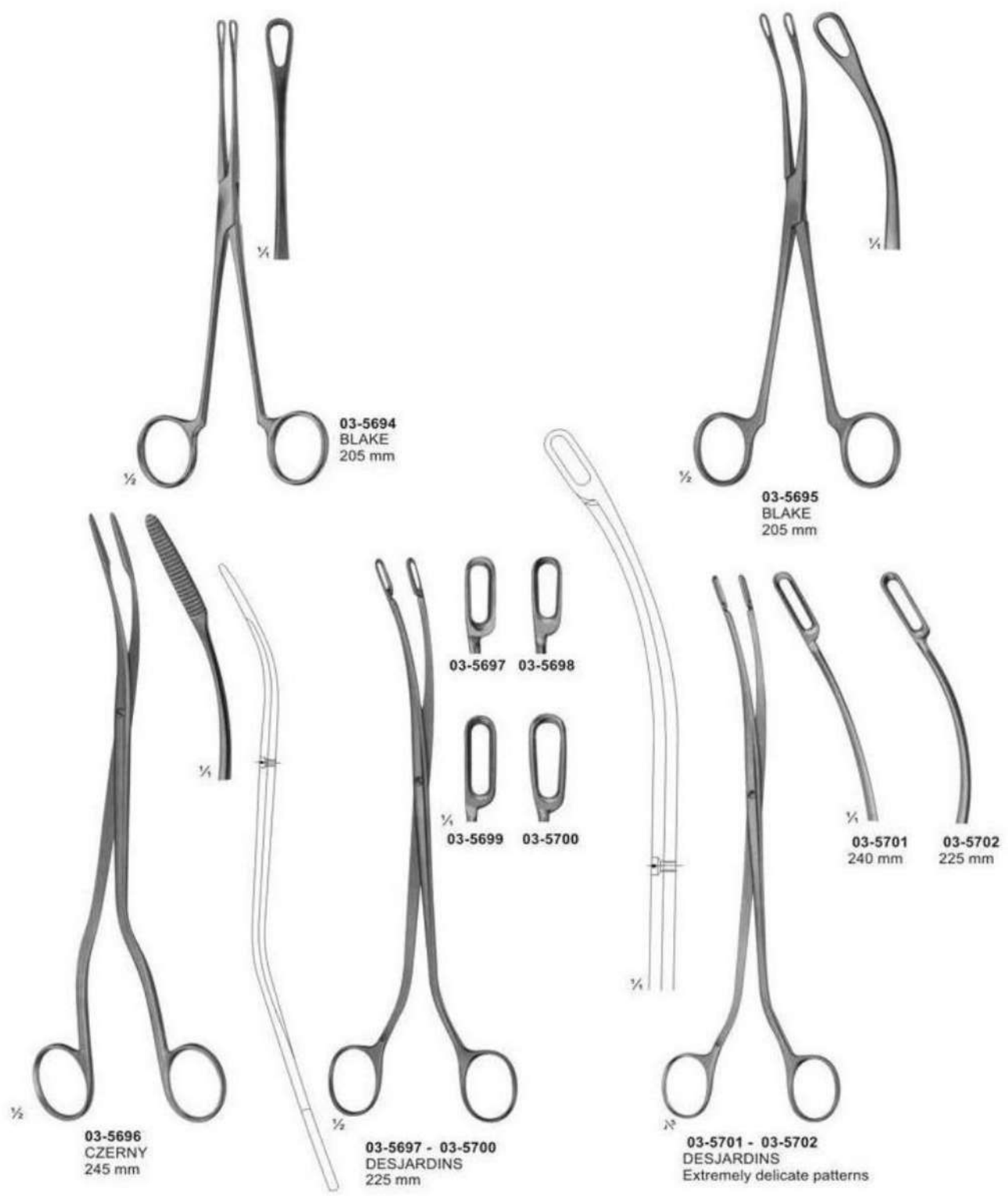

Atraumata

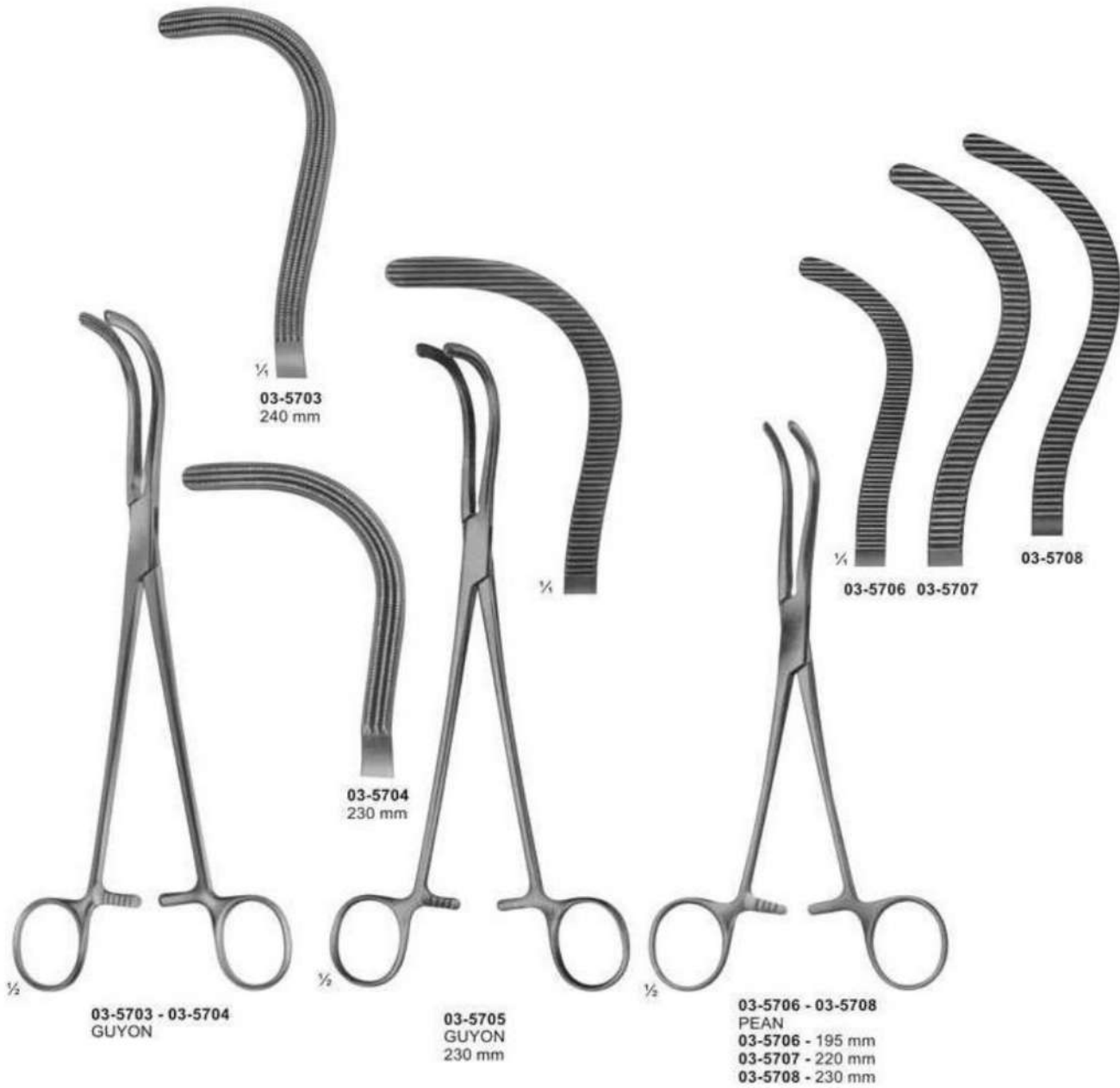



03-5709
STILLE
220 mm

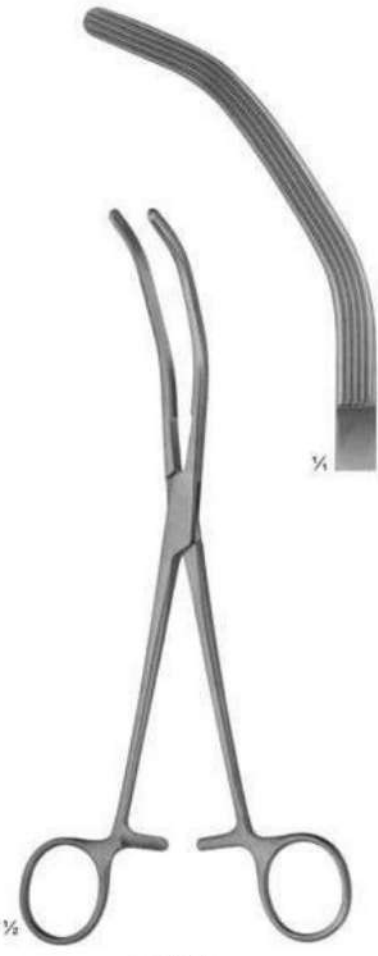

03-5710
HERRICK
225 mm



03-5711
WERTHEIM
225 mm



½

03-5712
COLLIN
285 mm



½

03-5713
DARTIGUES
255 mm



03-5714 - 03-5717
RANDALL
225 mm



03-5718 - 03-5719
RANDALL
190 mm

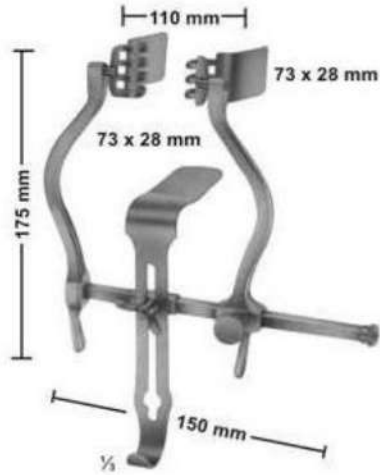

03-5720
JUDD-MASSON
Bladder-and suprapubic
retractor

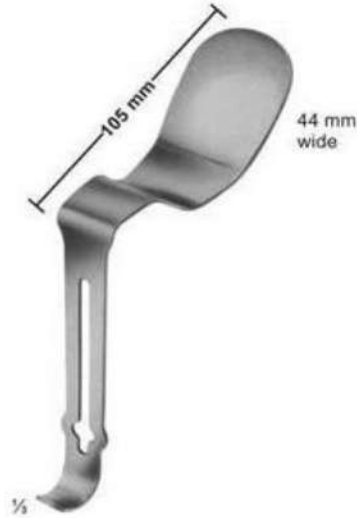

03-5721
MILLIN
Center blade for (05-6993)
retro pubic prostatectomy



03-5722
MILLIN
Bladder retractor
03-5722 Spreader only
03-5723 Blades 57x25mm
03-5724 Blades 82x25mm
03-5725 Center blade 105x45mm



03-5726
LEGUEU
Bladder retractor
Center blade
80 x 31 mm



03-5727
LEGUEU
Bladder spatula
260 mm

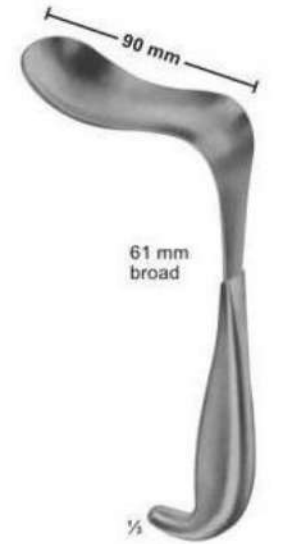

03-5728
KOCHER
Bladder spatula
235 mm



03-5729
MATHIEU
Foreign body forceps
Length of shaft
190 mm



03-5730
MILLIN
Lobe grasping
forceps
235 mm



03-5731
Ureter forceps
240 mm

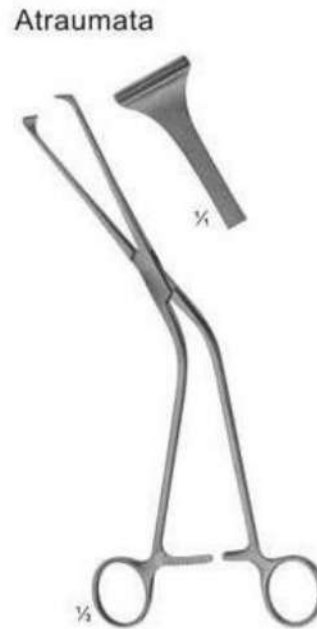

03-5732
MILLIN
Lobe grasping
forceps
245 mm



03-5733
MILLIN
Bladder neck spreader
285 mm



03-5734
GUYON
Catheter guide
(introducer)
365 mm

**Charr.
(French)**

- 03-5735 6
- 03-5736 7
- 03-5737 8
- 03-5738 9
- 03-5739 10
- 03-5740 11
- 03-5741 12
- 03-5742 13
- 03-5743 14
- 03-5744 15
- 03-5745 16
- 03-5746 18
- 03-5747 20



03-5735 - 03-5747
Female catheters,
metal
160 mm

**Charr.
(French)**

- 03-5748 8
- 03-5749 9
- 03-5750 10
- 03-5751 11
- 03-5752 12
- 03-5753 13
- 03-5754 14
- 03-5755 15
- 03-5756 16
- 03-5757 17
- 03-5758 18
- 03-5759 19
- 03-5760 20
- 03-5761 21
- 03-5762 22
- 03-5763 23
- 03-5764 24
- 03-5765 25
- 03-5766 26
- 03-5767 27
- 03-5768 28
- 03-5769 29
- 03-5770 30

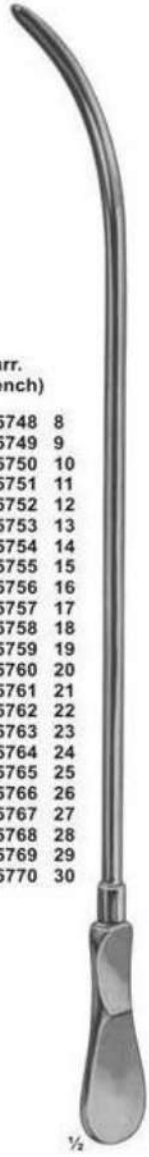

03-5748 - 03-5770
DITTEL
Urethral bougies
and dilating sounds
345 mm

- 03-5771 Ben. 24/Charr. 12
- 03-5772 Ben. 25
- 03-5773 Ben. 26/Charr. 13
- 03-5774 Ben. 27
- 03-5775 Ben. 28/Charr. 14
- 03-5776 Ben. 29
- 03-5777 Ben. 30/Charr. 15
- 03-5778 Ben. 31
- 03-5779 Ben. 32/Charr. 16
- 03-5780 Ben. 33
- 03-5781 Ben. 34/Charr. 17
- 03-5782 Ben. 35
- 03-5783 Ben. 36/Charr. 18
- 03-5784 Ben. 37
- 03-5785 Ben. 38/Charr. 19
- 03-5786 Ben. 39
- 03-5787 Ben. 40/Charr. 20
- 03-5788 Ben. 41
- 03-5789 Ben. 42/Charr. 21
- 03-5790 Ben. 43
- 03-5791 Ben. 44/Charr. 22
- 03-5792 Ben. 45
- 03-5793 Ben. 46/Charr. 23
- 03-5794 Ben. 47
- 03-5795 Ben. 48/Charr. 24
- 03-5796 Ben. 49
- 03-5797 Ben. 50/Charr. 25
- 03-5798 Ben. 51
- 03-5799 Ben. 52/Charr. 26
- 03-5800 Ben. 53
- 03-5801 Ben. 54/Charr. 27
- 03-5802 Ben. 55
- 03-5803 Ben. 56/Charr. 28
- 03-5804 Ben. 57
- 03-5805 Ben. 58/Charr. 29
- 03-5806 Ben. 59
- 03-5807 Ben. 60/Charr. 30

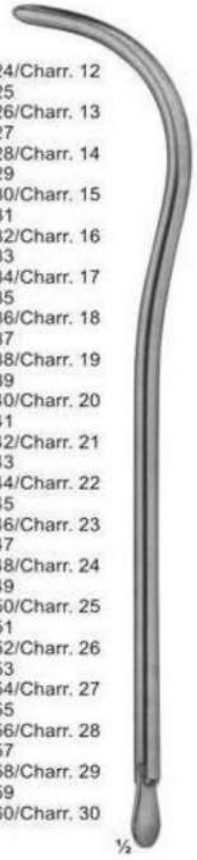

03-5771 - 03-5807
GUYON
Urethral bougies
and dilating sounds,
without filiform guides,
with thread in tip
255 mm



03-5808 GUYON Set of urethral bougies and dilating sounds, in metal case, with lift out rack and bottom rack, containing 21 urethral and dilating sounds, metal.



03-5809 - 03-5811 WINKELMANN 03-5809 ∅ 12mm 03-5810 ∅ 16mm 03-5811 ∅ 20mm

Circumcision Clamps

Assisted by two haemostats or ligatures the foreskin is pushed over the bellshaped protection - rod and the glans is placed into it. By now, the wing - nut is tightened as close as possible, so the foreskin in annular compressed. The foreskin is cut of with a scalpel, right nest to the compression ring. The circumcision clamp remains a few minutes to avoid bleeding. In case that any large vein, specially the frenular artery, is cut through, a ligature must be set. The advantage of the method described is the cosmeticy favourable scar which is left after rejection of the small necrotized portion.

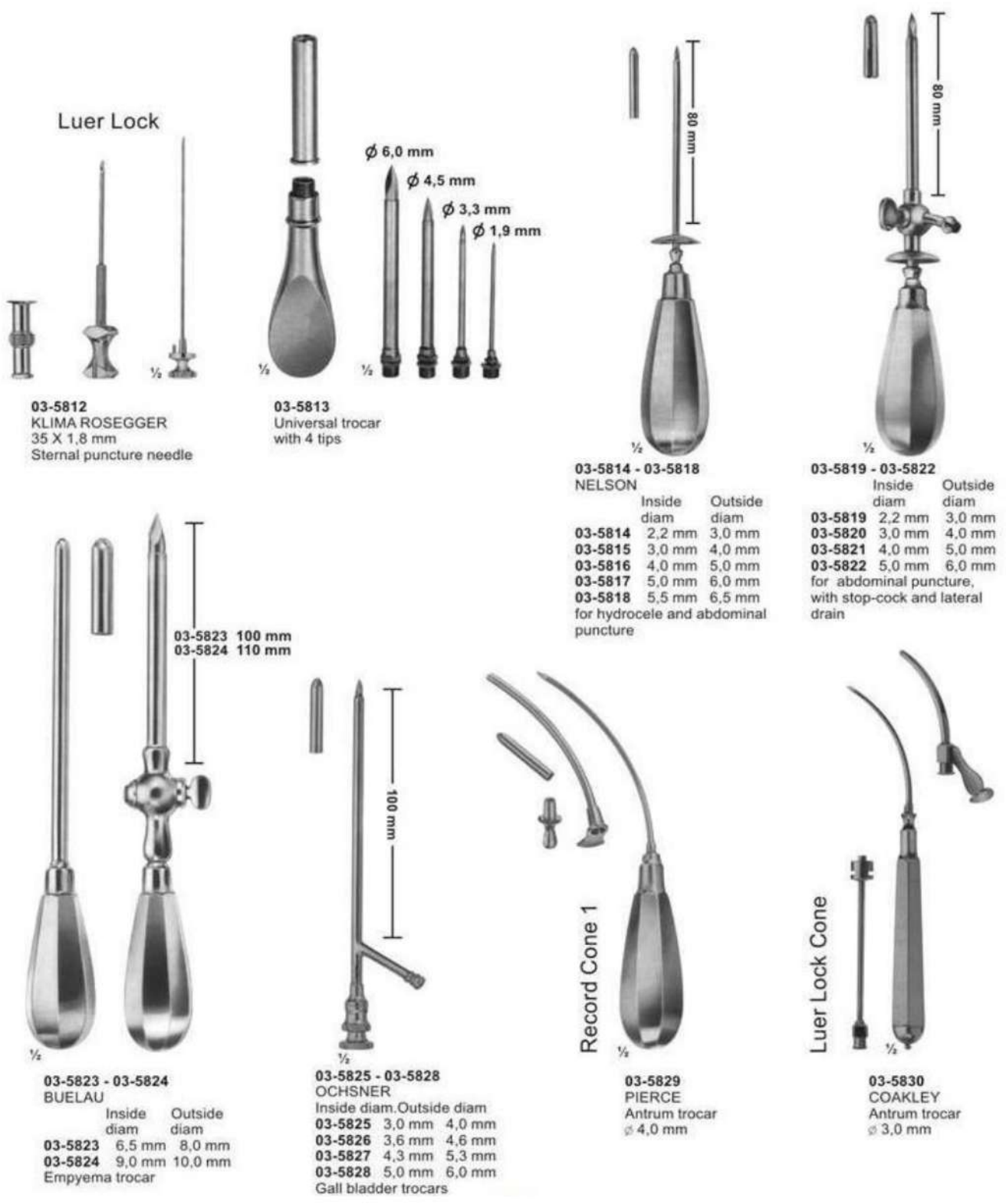

Luer Lock



03-5812
KLIMA ROSEGGER
35 X 1,8 mm
Sternal puncture needle

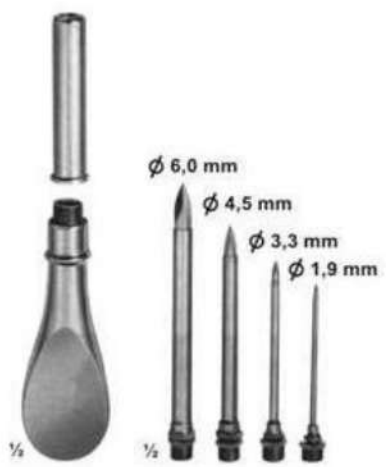

03-5813
Universal trocar
with 4 tips



03-5814 - 03-5818
NELSON

	Inside diam	Outside diam
03-5814	2,2 mm	3,0 mm
03-5815	3,0 mm	4,0 mm
03-5816	4,0 mm	5,0 mm
03-5817	5,0 mm	6,0 mm
03-5818	5,5 mm	6,5 mm

for hydrocele and abdominal puncture



03-5819 - 03-5822

	Inside diam	Outside diam
03-5819	2,2 mm	3,0 mm
03-5820	3,0 mm	4,0 mm
03-5821	4,0 mm	5,0 mm
03-5822	5,0 mm	6,0 mm

for abdominal puncture, with stop-cock and lateral drain



03-5823 100 mm
03-5824 110 mm

03-5823 - 03-5824
BUELAU

	Inside diam	Outside diam
03-5823	6,5 mm	8,0 mm
03-5824	9,0 mm	10,0 mm

Empyema trocar



03-5825 - 03-5828
OCHSNER

	Inside diam	Outside diam
03-5825	3,0 mm	4,0 mm
03-5826	3,6 mm	4,6 mm
03-5827	4,3 mm	5,3 mm
03-5828	5,0 mm	6,0 mm

Gall bladder trocars



03-5829
PIERCE
Antrum trocar
∅ 4,0 mm



03-5830
COAKLEY
Antrum trocar
∅ 3,0 mm

Section - 04



Pages 209-254

- ★ Vaginal Specula & Retractors
- ★ Utrine Dilators, Probes,
Forceps, Myoma Instruments
- ★ Biopsy Instruments,
Utrine Curettes / Scoops
- ★ Obstetrics Instruments

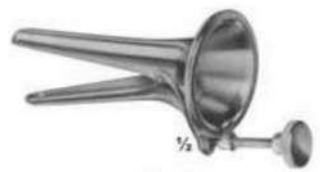

04-6001
COLLIN
for children
53 x 10 mm

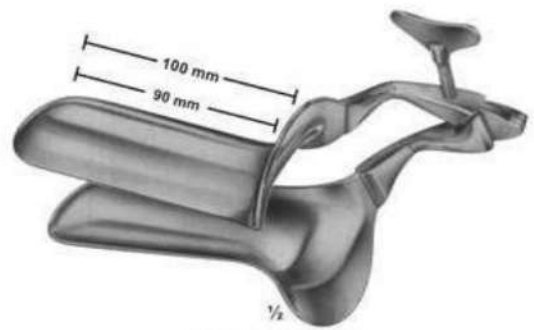

04-6002 - 04-6005
COLLIN

04-6002	100/90mm	28 mm
04-6003	100/90mm	32 mm
04-6004	105/95mm	35 mm
04-6005	115/105mm	40 mm

 Total length/working length width



04-6006
COLLIN
for virgins
95/85 x 18 mm



04-6007
CUSCO
for virgins
75 x 17 mm



04-6008
CUSCO
for virgins
75 x 17 mm

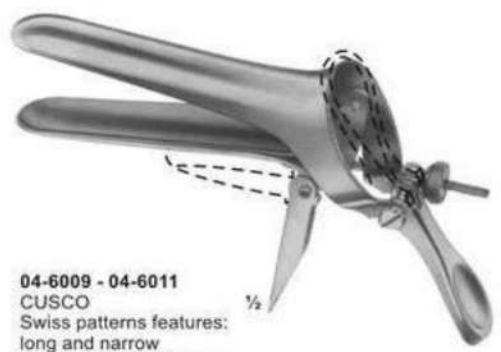

04-6009 - 04-6011
CUSCO
Swiss patterns features:
long and narrow

04-6009	92x23-25 mm
04-6010	100x25-27 mm
04-6011	110x27-30 mm



1/2
04-6012 - 04-6015
CUSCO
STANDARD
04-6012 80X24 mm
04-6013 80X32 mm
04-6014 90X36 mm
04-6015 110X37 mm



1/2
04-6016 - 04-6019
CUSCO
04-6016 80X24 mm
04-6017 80X32 mm
04-6018 90X36 mm
04-6019 110X37 mm



Flat (duck beak)

1/2
04-6020 - 04-6022
CUSCO
04-6020 80X32 mm
04-6021 90X37 mm
04-6022 115X37 mm



1/2
04-6023 - 04-6024
SEYFFERT
04-6023 100X17 mm
04-6024 110X33 mm
230 mm



With double ratchet, closing and opening of ratchet by pressure of thumb

1/2
04-6025
SEMM
for children and virgins
180 mm
90X14-18mm



04-6026 - 04-6028
GRAVE
04-6026 75X20 mm
04-6027 95X30 mm
04-6028 105X33 mm



04-6029 - 04-6030
PEDERSON
04-6029 100X22 mm
04-6030 120X25 mm



04-6031 - 04-6032
BRIESKY
04-6031 72X25 mm / 77X30 mm 140mm
04-6032 75X30 mm / 92X38 mm 170mm



04-6033 - 04-6035
SIMS
04-6033 70X26 mm / 75 X30 mm
125 mm
04-6034 75X30 mm / 80X35 mm
150 mm
04-6035 80X36 mm / 90X40mm
175mm



04-6036 - 04-6038
SEIDL
04-6036 80X8 mm
04-6037 80X10 mm
04-6038 90X14 mm
For children and infants
170 mm



04-6039
KRISTELLER
70X15 mm, (170 mm)
For children



04-6040 - 04-6042
KRISTELLER
04-6040 70X27 mm
04-6041 75X30 mm
04-6042 90X36 mm
175 mm



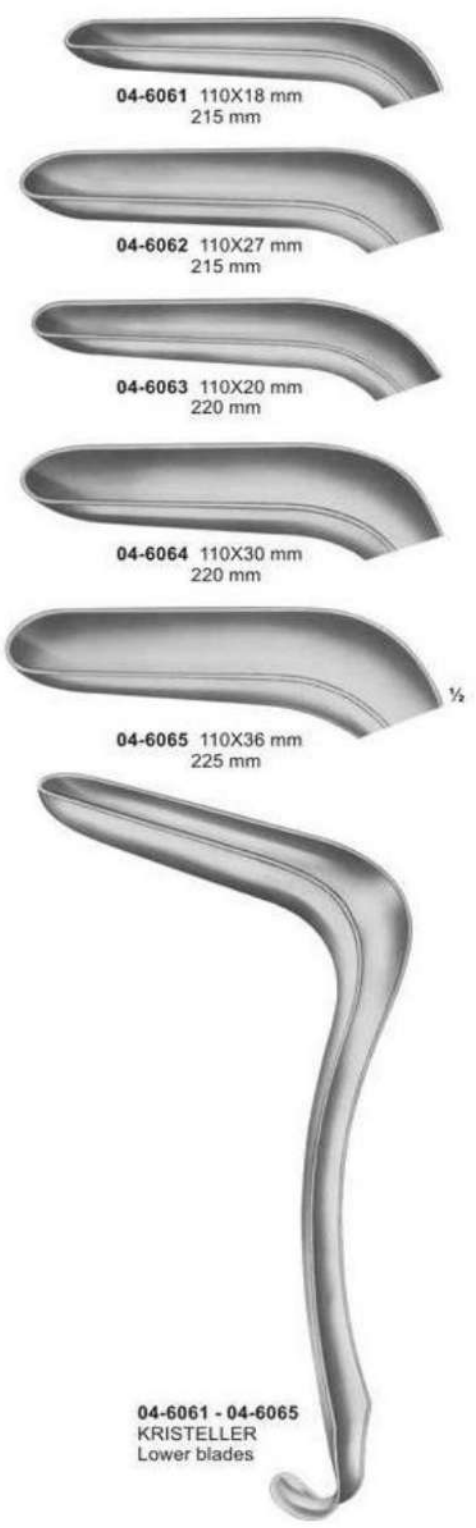
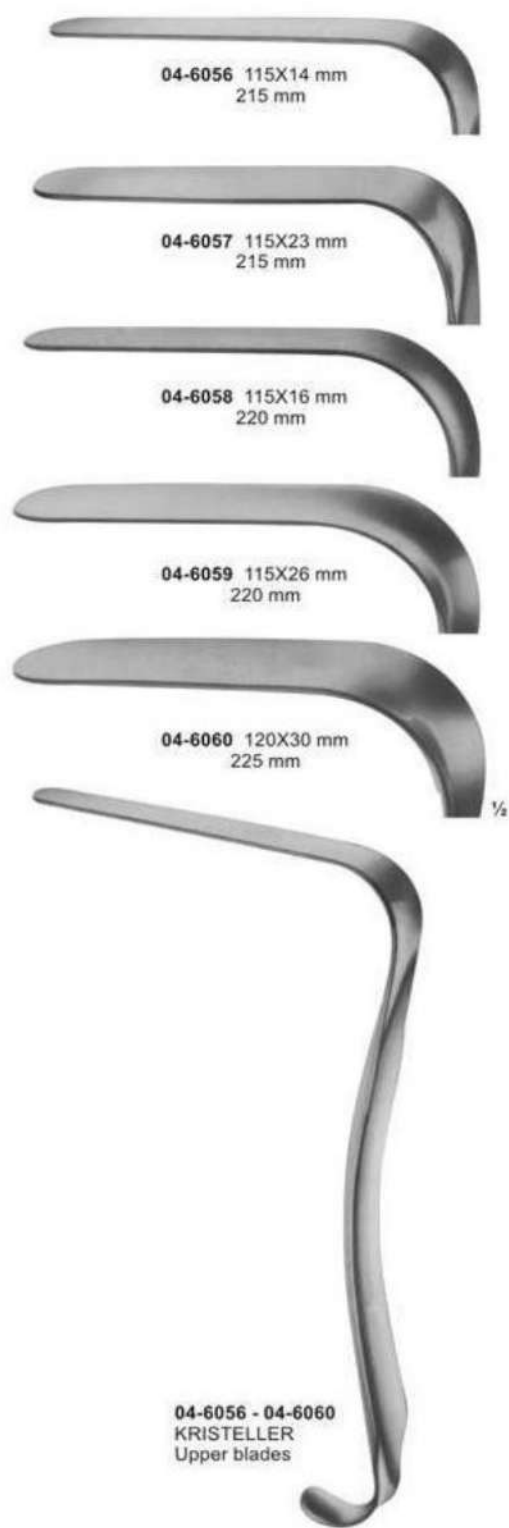



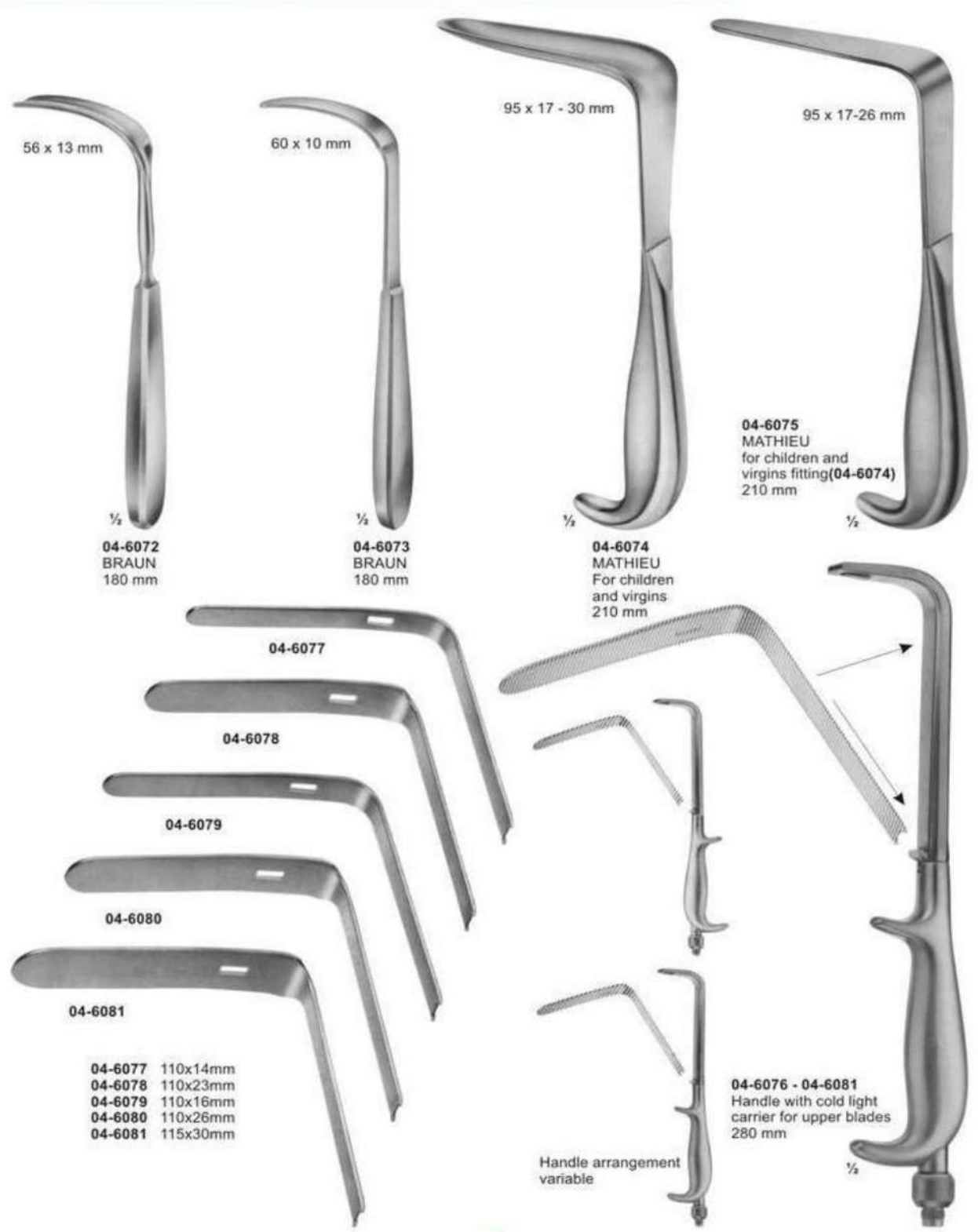





04-6095 - 04-6099
BREISKY
WIENER MODELL/
VIENNA PATTERN
04-6095 100 X 20 mm
04-6096 100 X 25 mm
04-6097 100 X 30 mm
04-6098 100 X 35 mm
04-6099 100 X 40 mm
300 mm



04-6100 - 04-6104
BREISKY
WIENER MODELL/
VIENNA PATTERN
04-6100 130 X 20 mm
04-6101 130 X 25 mm
04-6102 130 X 30 mm
04-6103 130 X 35 mm
04-6104 130 X 40 mm
320 mm



04-6107
removable strainer only



04-6105 - 04-6106
WEISSBARTH
04-6105 80 X 28 mm
04-6106 85 X 42 mm
210 mm

04-6108
DOYEN
lateral speculum
80 x 30 mm
250 mm



04-6109 - 04-6110
SIMON
115 X 22 mm
275 mm

1/2

04-6112 - 04-6113
AUVARD
04-6112 75 X 42-40 mm
04-6113 105 X 43-40 mm
1,470 kg = 3 lbs
with detachable weight
230 mm

1/2



04-6111
AUVARD
65 X 38 mm - 28 mm
1,530 kg = 3 lbs
with fixed weight
230 mm

1/2



04-6110
115 X 26 mm
275 mm

1/2

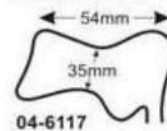
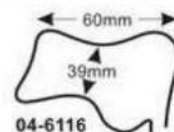
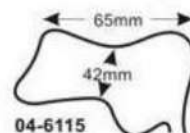
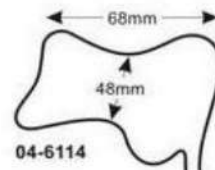

04-6114 - 04-6117
MARTIN
with hook shaped
handle for hanging
in weights
270 mm

1/2



04-6118
80 X 30

04-6119
85 X 35

04-6120
85 X 40



04-6121
55 X 40 - 60 mm



04-6122
70 X 45 - 70 mm



04-6123

04-6124

The mentioned blades (**04-6118 - 04-6122** and **04-6125 - 04-6132**) can be exchanged. They fit handle (**04-6123**), as well as handles (**04-6133** and **04-6134**).

04-6118 - 04-6124
SCHERBACK
Set consisting of:
handle **04-6123**
weight **04-6124**
4 blades **04-6118 - 04-6121**



04-6125
80 X 30 mm

04-6126
85 X 33 mm

04-6127
100 X 38 mm

04-6128
110 X 42 mm



04-6129
65 X 30 mm

04-6130
75 X 35 mm

04-6131
85 X 35 mm

04-6132
95 X 35 mm

04-6133
BOZEMANN
Set consisting of:
2 handle (**04-6133 - 04-6134**)
8 blades (**04-6125 - 04-6132**)

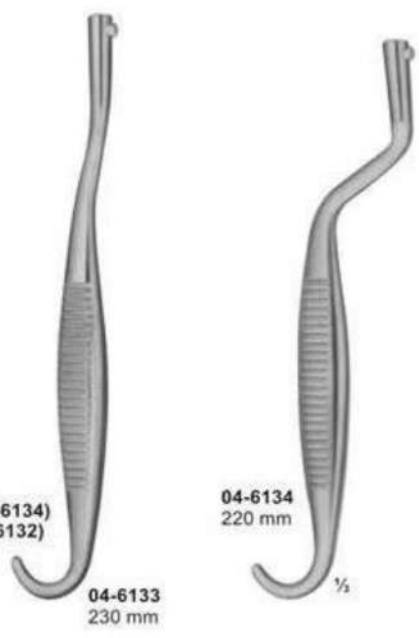

04-6133
230 mm

04-6134
220 mm



½
04-6135
JOLL (FRIEDMAN)
155 mm



½
04-6136
RICHTER
170 mm



½
04-6137
GELPI
135 mm



½
04-6138
GELPI
175 mm



04-6139	1	mm	04-6161	23	mm
04-6140	2	mm	04-6162	24	mm
04-6141	3	mm	04-6163	25	mm
04-6142	4	mm	04-6164	26	mm
04-6143	5	mm	04-6165	1	½mm
04-6144	6	mm	04-6166	2	½mm
04-6145	7	mm	04-6167	3	½mm
04-6146	8	mm	04-6168	4	½mm
04-6147	9	mm	04-6169	5	½mm
04-6148	10	mm	04-6170	6	½mm
04-6149	11	mm	04-6171	7	½mm
04-6150	12	mm	04-6172	8	½mm
04-6151	13	mm	04-6173	9	½mm
04-6152	14	mm	04-6174	10	½mm
04-6153	15	mm	04-6175	11	½mm
04-6154	16	mm	04-6176	12	½mm
04-6155	17	mm	04-6177	13	½mm
04-6156	18	mm	04-6178	14	½mm
04-6157	19	mm	04-6179	15	½mm
04-6158	20	mm	04-6180	16	½mm
04-6159	21	mm	04-6181	17	½mm
04-6160	22	mm			

04-6139 - 04-6181
HEGAR
with very conical point
185 mm



04-6182	1+2	mm
04-6183	3+4	mm
04-6184	5+6	mm
04-6185	7+8	mm
04-6186	9+10	mm
04-6187	11+12	mm
04-6188	13+14	mm
04-6189	15+16	mm
04-6190	17+18	mm

04-6182 - 04-6190
HEGAR
205 mm



04-6191
HEGAR
Uterine dilator set, in canvas roll
with 8 dilators.



04-6192
HEGAR
Dilator set consisting of:
14 Dilators,
(04-6193)1 Rack for dilators (4 - 12 mm)
(04-6194)1 Rack for Dilators (13 - 17 mm)
(04-6195)1 Metal case only,
with hinged lid, stainless 200 X 100 X 35 mm



04-6196
HEGAR
Dilator set consisting of:
26 Dilators,
(04-6197)1 Rack for dilators (1 - 17 mm)
(04-6198)1 Rack for Dilators (18 - 26 mm)
(04-6199)1 Metal case only,
with hinged lid, of aluminium 330 X 220 X 80 mm



04-6200
KOGAN
Endospecula for cervix
and urethra, without ratchet
240 mm



04-6201
KOGAN
Endospecula for cervix
and urethra, with
scale-ratchet and fixing screws
240 mm

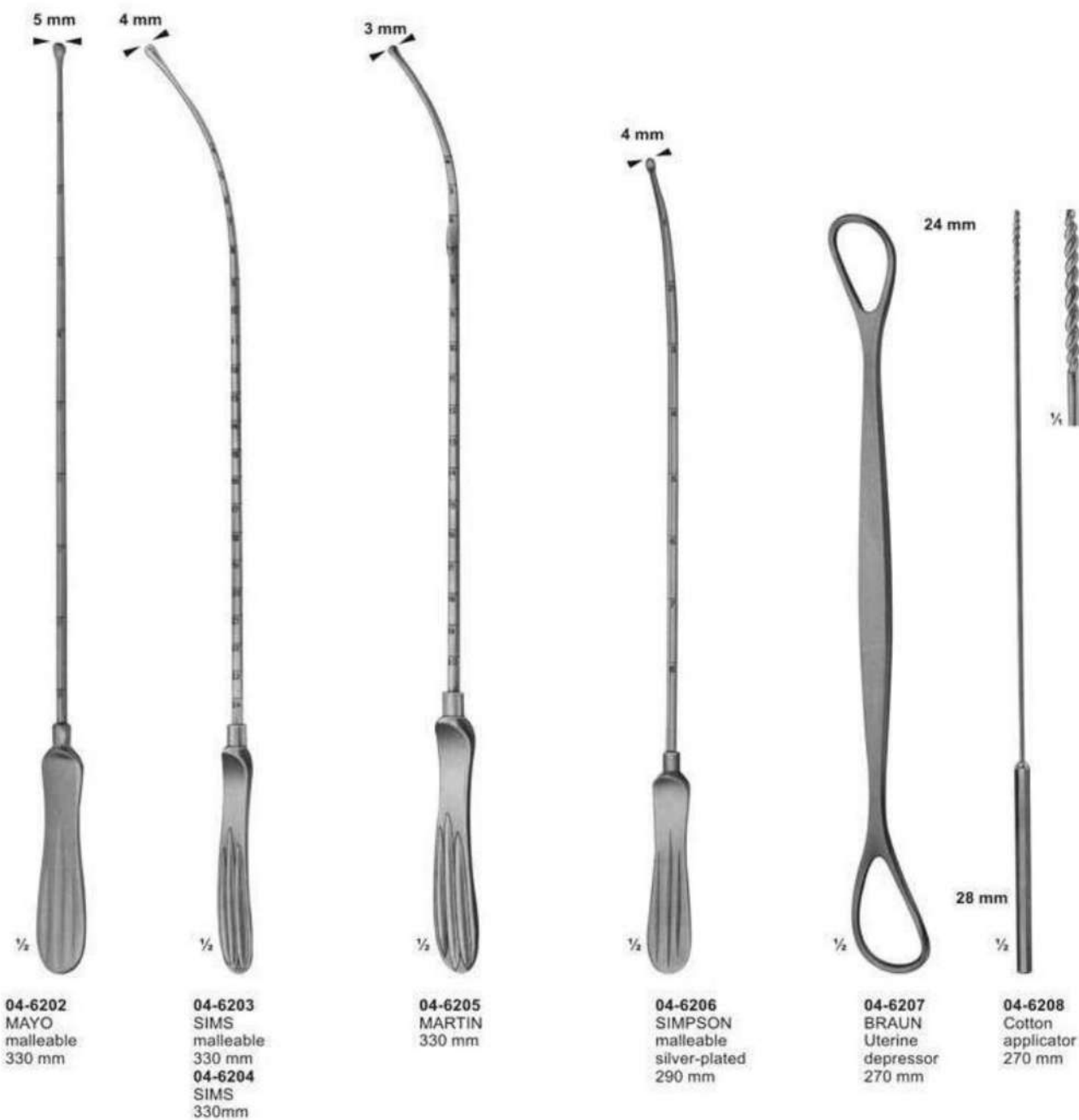



04-6209
PELKMANN
260 mm

04-6210
PELKMANN
260 mm

04-6211
BOZEMANN
250 mm

04-6212
BOZEMANN
255 mm

Jaws with longitudinal groove

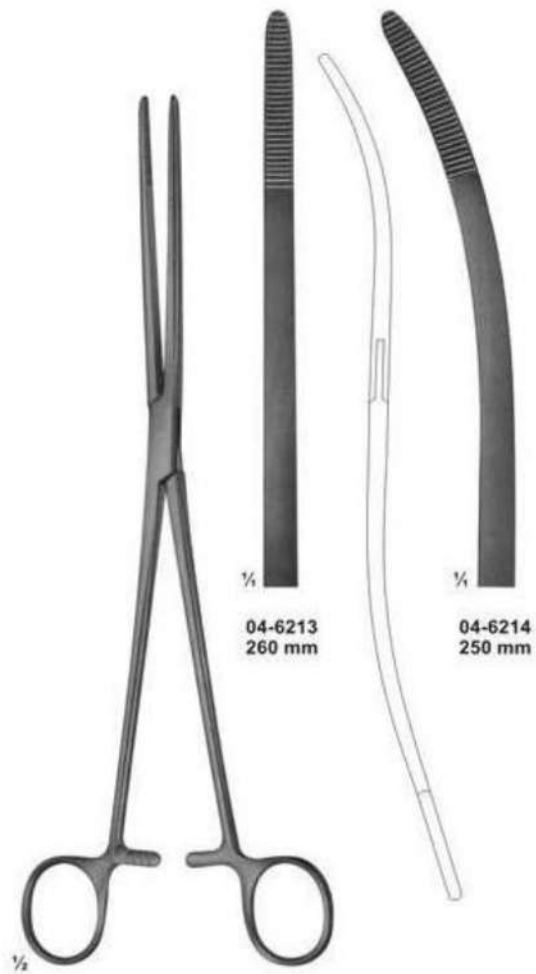

04-6213 - 04-6214
BOZEMANN



04-6215
BOZEMANN-DOUGLAS
260 mm

Standard



04-6216
BRAUN
slender type
250 mm



04-6217
SCHROEDER
250 mm



04-6218
POZZI
heavy type
255 mm



**04-6219
MARTIN**
265 mm

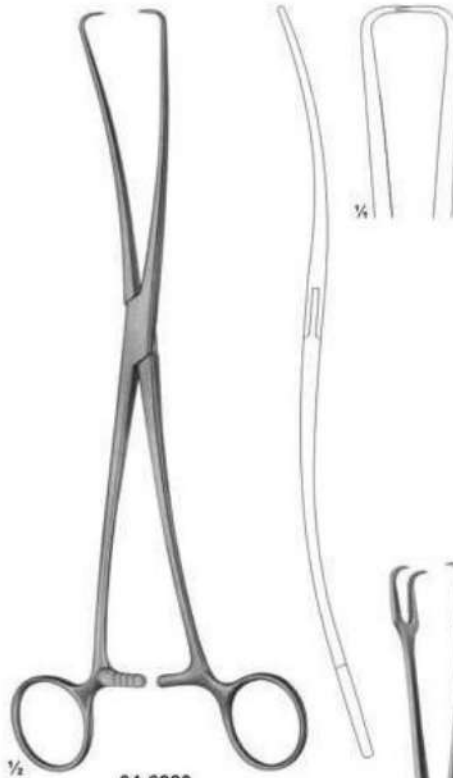

**04-6220
DUPLAY**
250 mm

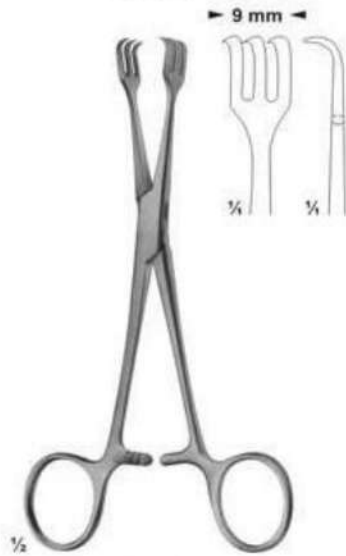

**04-6221
LAHEY**
155 mm



**04-6222 - 04-6224
SCHROEDER**
250 mm

04-6222
straight

04-6223
curved
on flat

04-6224
curved
sideways

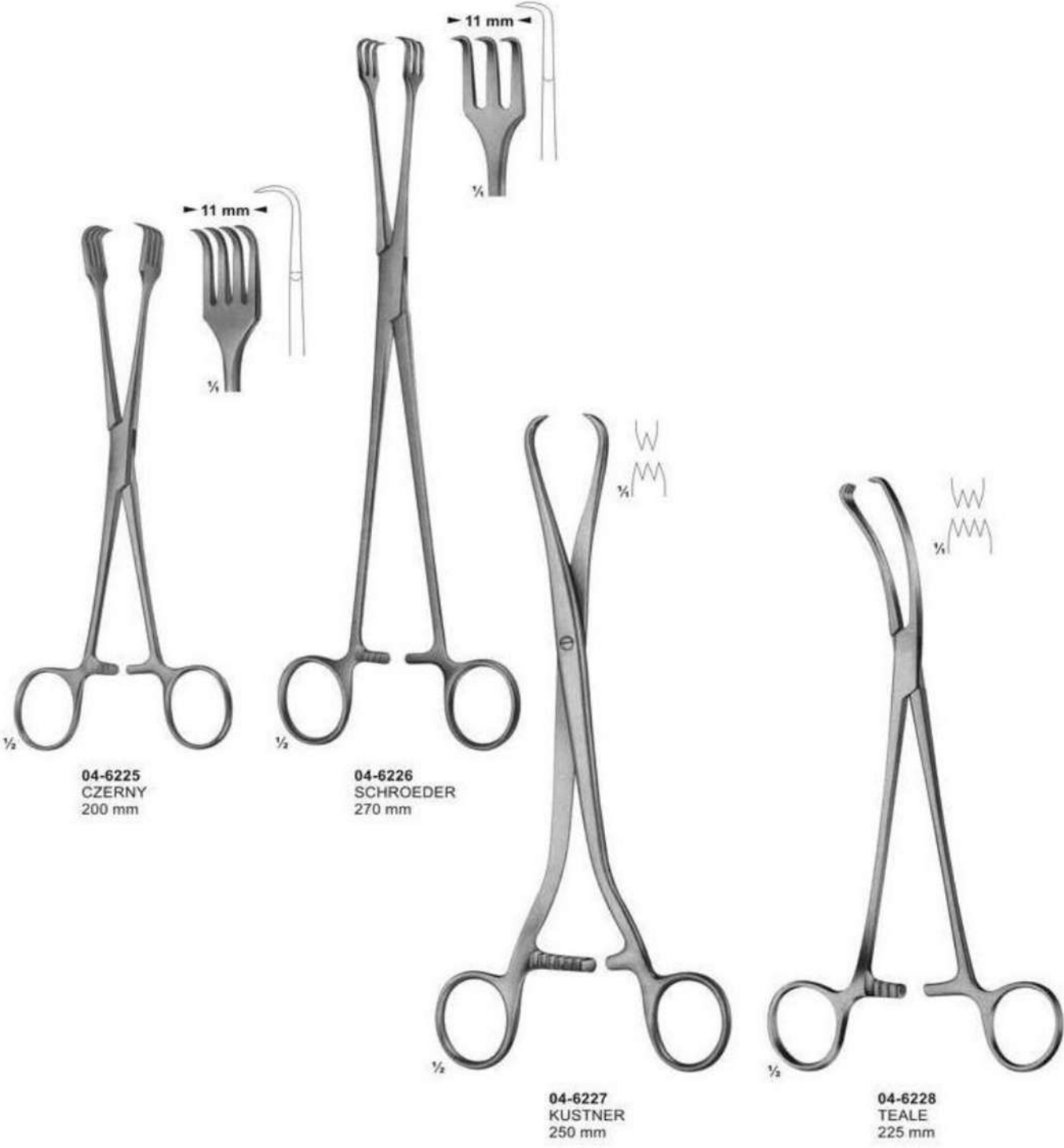

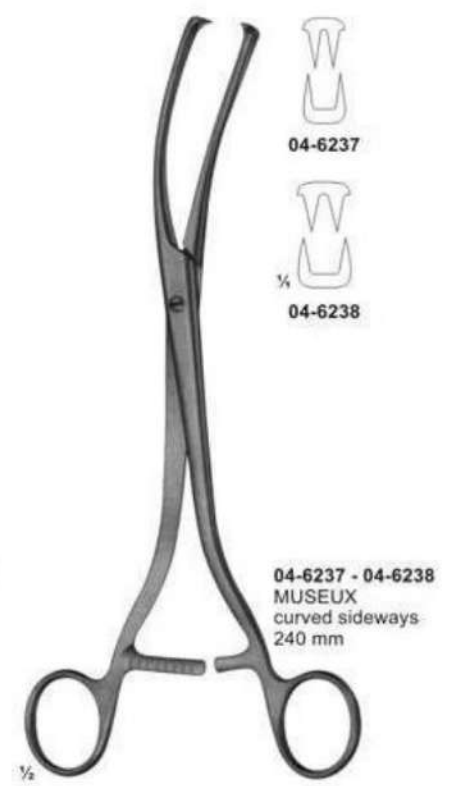
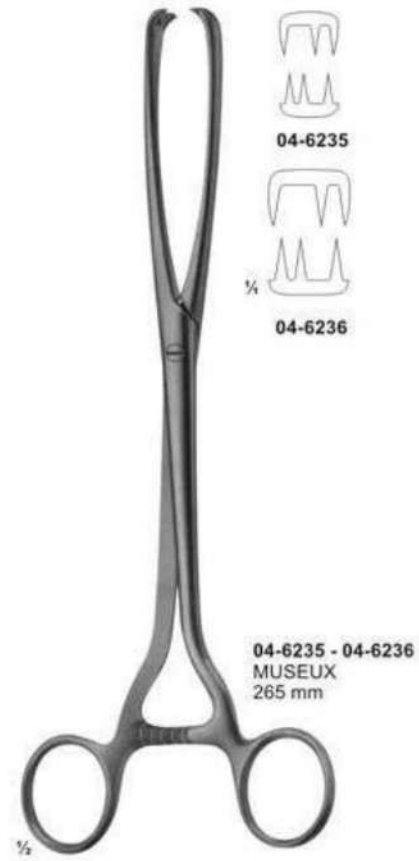
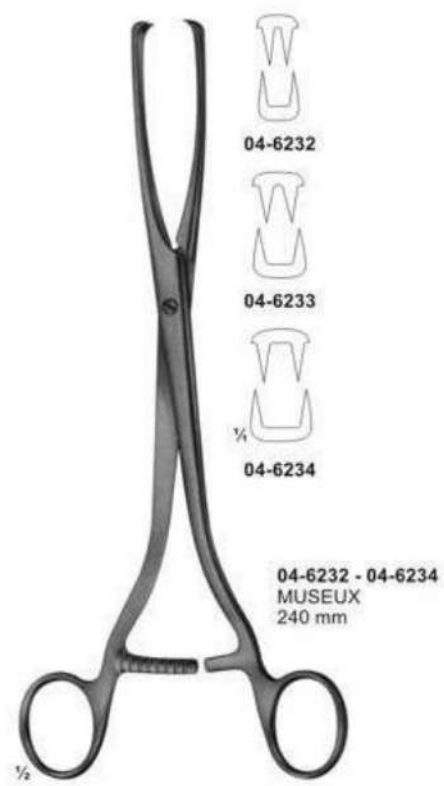

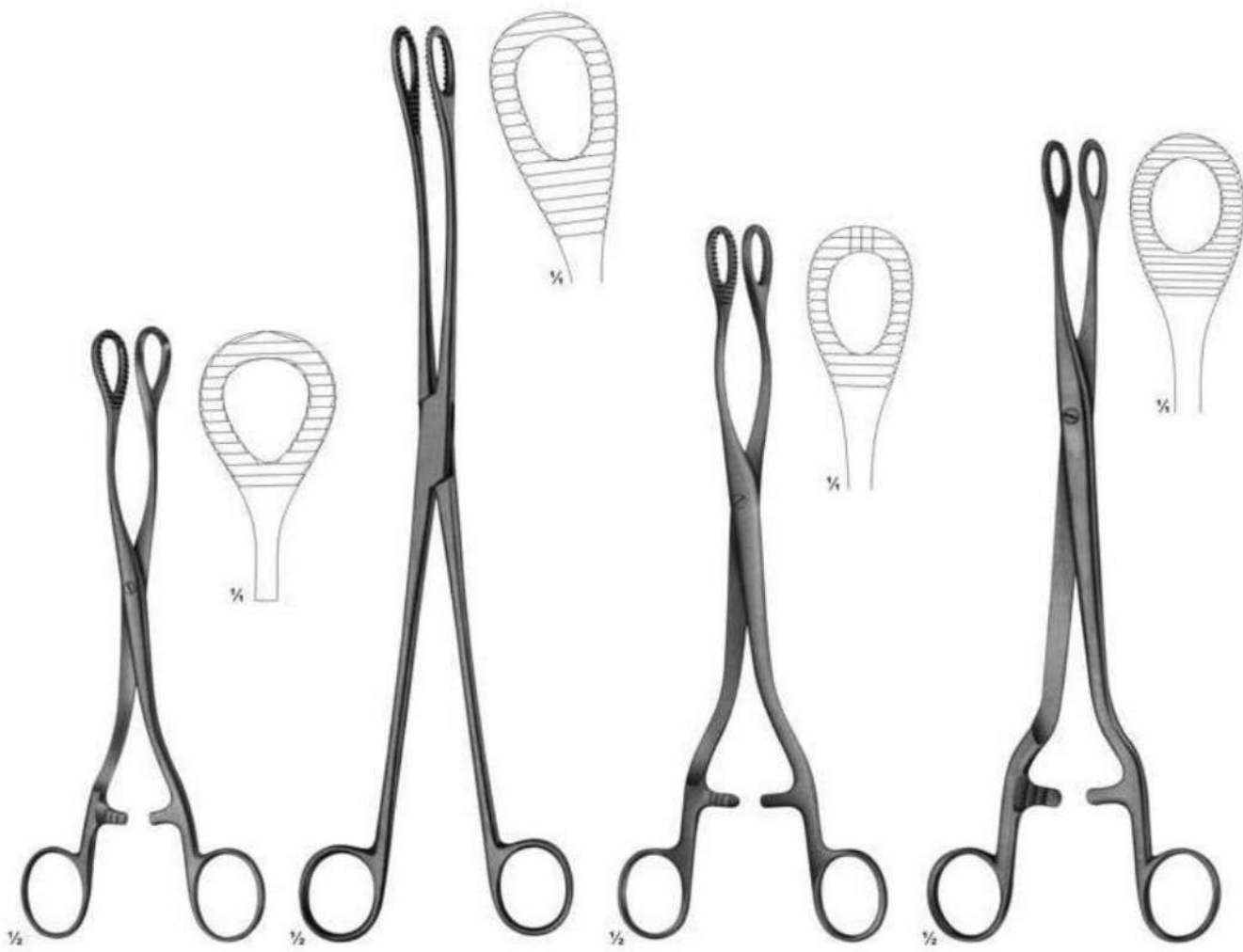

04-6239
HEYWOOD-SMITH
200 mm

04-6240
KELLY
320 mm

04-6241
HEYWOOD-SMITH
250 mm

04-6242
NOTO
280 mm

Atraumata



04-6244
250mm



04-6245
270mm



04-6243
DOYEN
185 mm



04-6244 - 04-6245



04-6246
BUMM
280 mm



04-6247
COLLIN
250 mm



04-6248
COLLIN
285 mm



04-6249
DARTIGUES
255 mm



04-6250
SOMER
235 mm



04-6251
STRASSMANN
265 mm



04-6252
COLLIN
265 mm



04-6253
APPREX
approx. 260 mm



04-6254
SEGOND
Myomatome
270 mm



04-6255
DOYEN
Myoma screw
150 mm



04-6256
DOYEN
Myoma screw
190 mm



04-6257 04-6258 04-6259
∅ 6mm ∅ 8mm ∅ 10mm

04-6257 - 04-6259
NEUBUSER
Tubal seizing forceps
200 mm

145 X 100 X 1.5 mm



04-6263
Silicon operating pad
pre-cut



04-6260
Splint guide
with thread



04-6261
Splint guide with
round handle
180 mm



04-6262
Angled glass rods
Set . 3 pieces



04-6264
Polyaethylen splint material
soft-sterile
0.45 mm

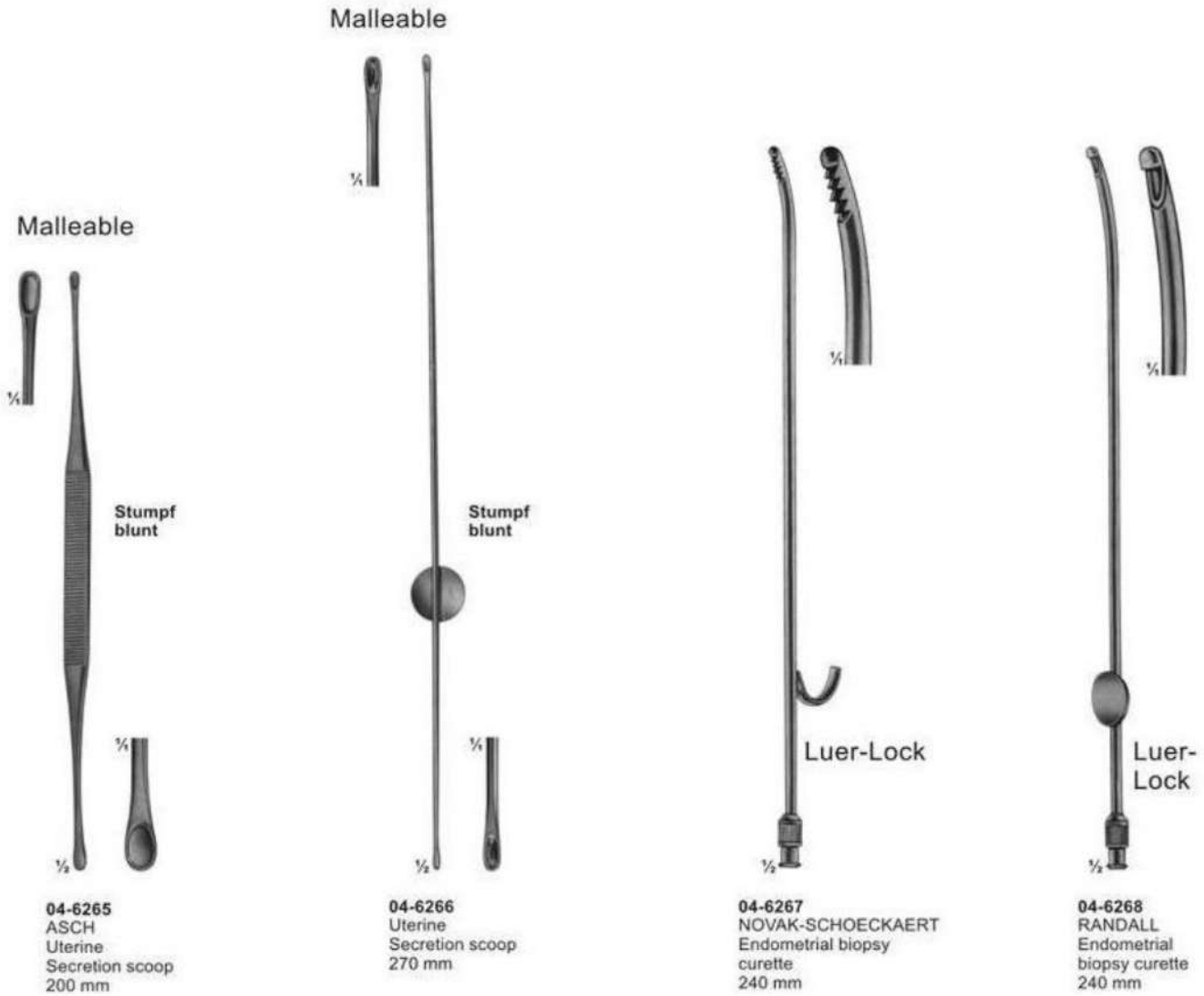

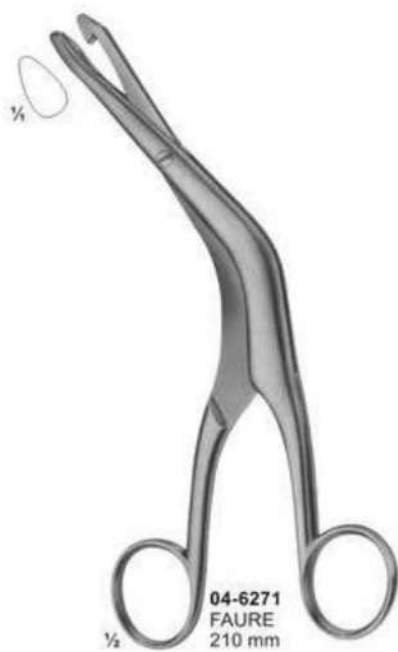
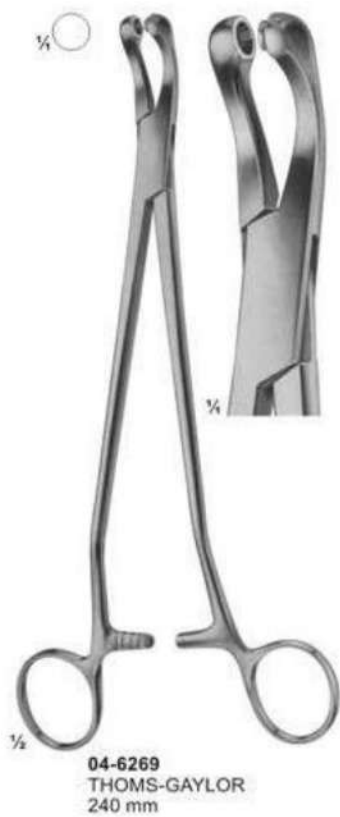



04-6273

04-6274

04-6275

04-6276

04-6275 - 04-6276
SCHUMACHER
suitable for
colposcopy

04-6273 - 04-6274
SCHUMACHER
240mm



04-6277 - 04-6279
SEIDL DBP
Biopsy forceps, bayonet shaped
for portio, vagina and vulva
240mm

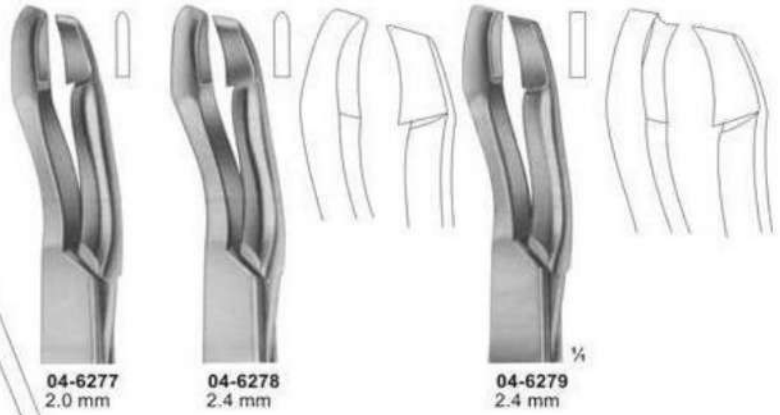

04-6277
2.0 mm

04-6278
2.4 mm

04-6279
2.4 mm

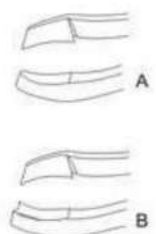

2 Different shapes of the jaw are available
a) Gothic shape
2.0 resp. 2.4mm wide (causes less bleeding)
b) Rectangular shape, 2.4mm wide

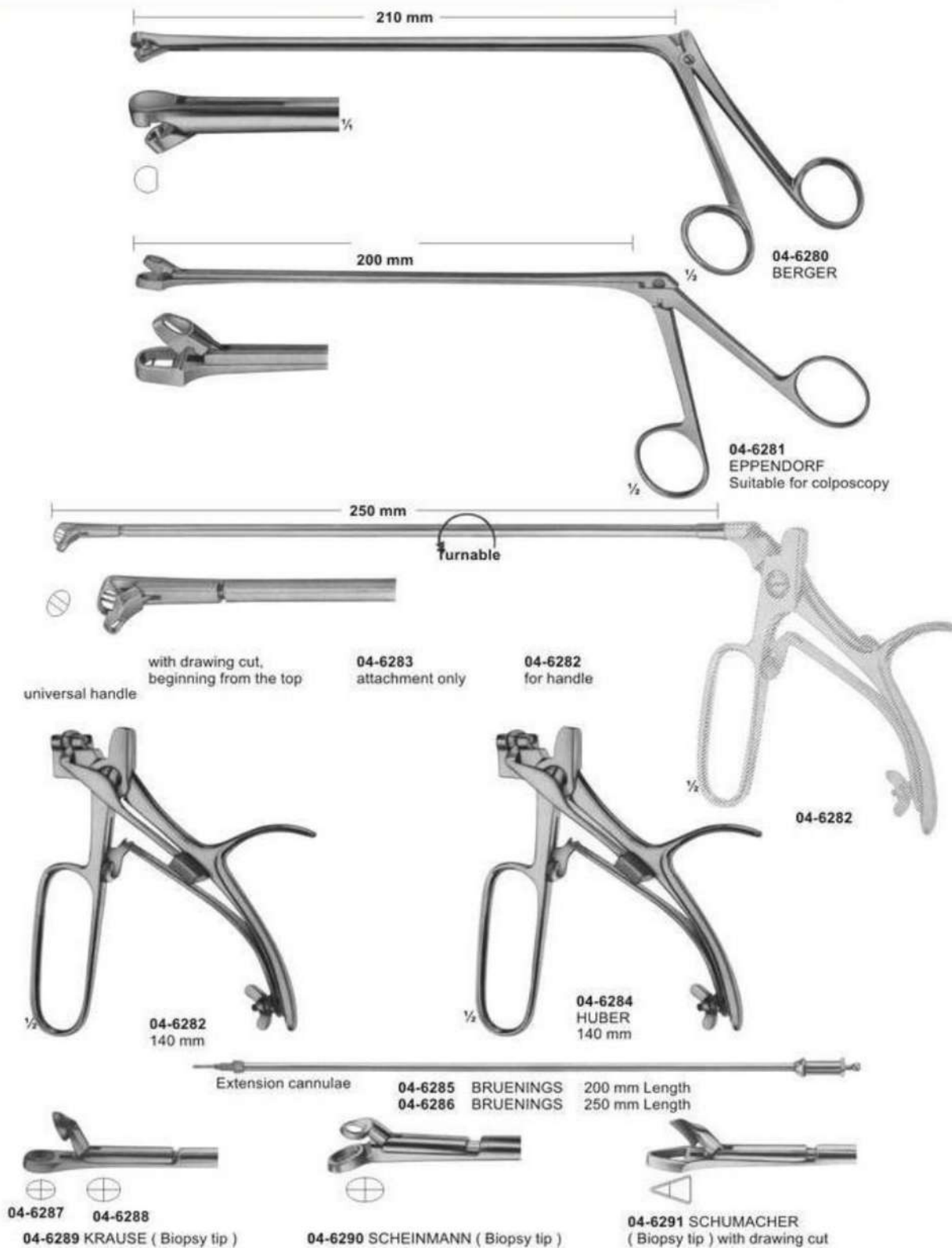

Table of Recamier		Sharp		Blunt
Fig	Width	Rigid	Malleable	Rigid
00	4.5mm	04-6294		
0	7.5mm	04-6295		04-6306
1	8.5mm	04-6296	04-6317	04-6307
2	10.5mm	04-6297	04-6318	04-6308
3	12.0mm	04-6298	04-6319	04-6309
4	14.0mm	04-6299	04-6320	04-6310
5	15.0mm	04-6300	04-6321	04-6311
6	16.5mm	04-6301	04-6322	04-6312
7	18.0mm	04-6302	04-6323	04-6313
8	19.5mm	04-6303	04-6324	04-6314
9	21.5mm	04-6304		04-6315
10	23.5mm	04-6305		04-6316
04-6294 - 04-6305		Sharp - Rigid		
04-6317 - 04-6324		Sharp - Malleable		
04-6306 - 04-6316		Blunt - Rigid		

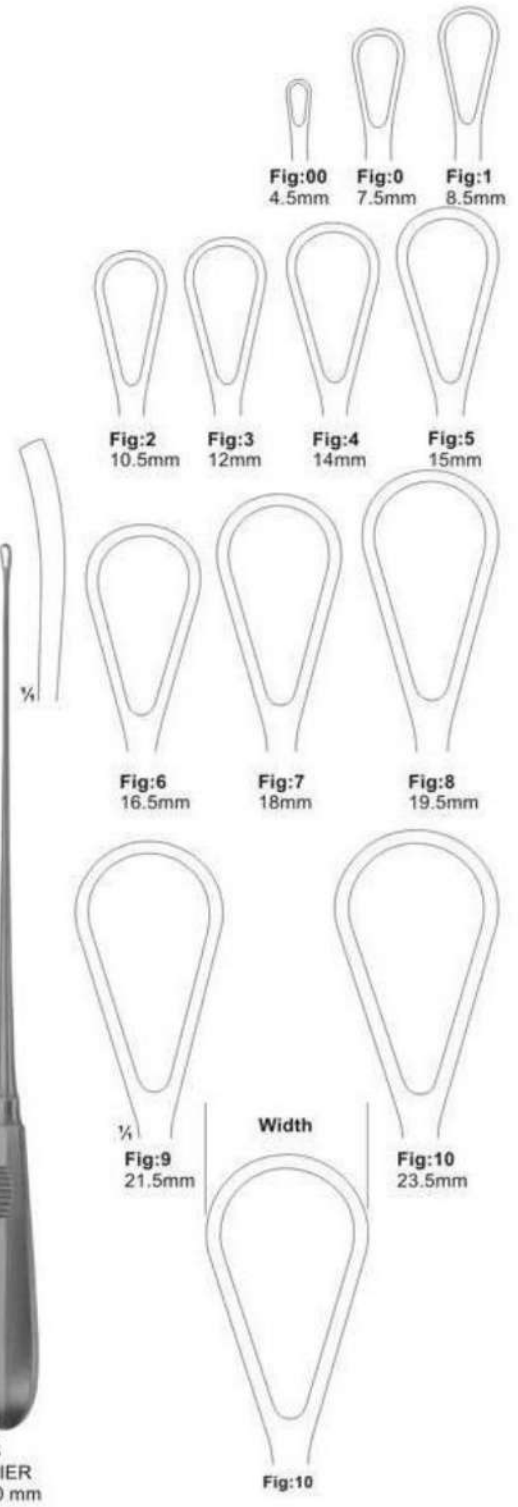
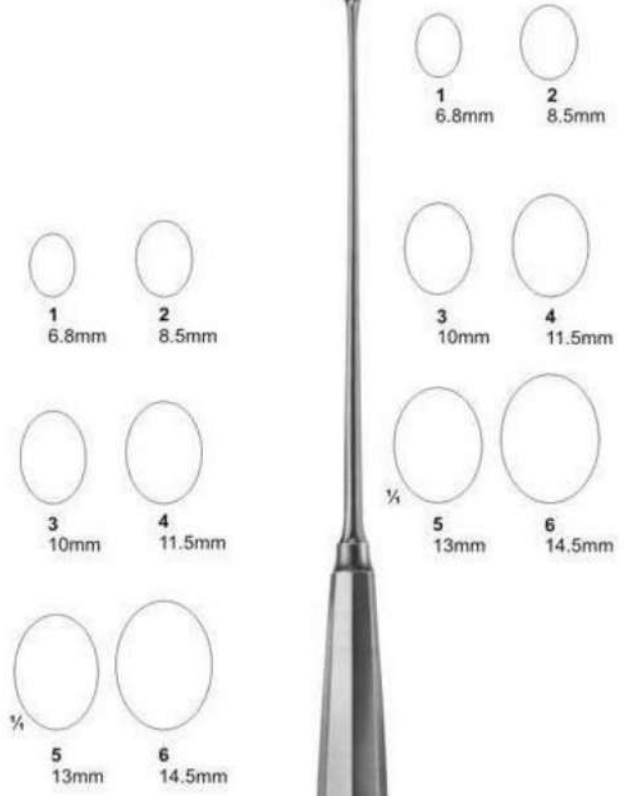
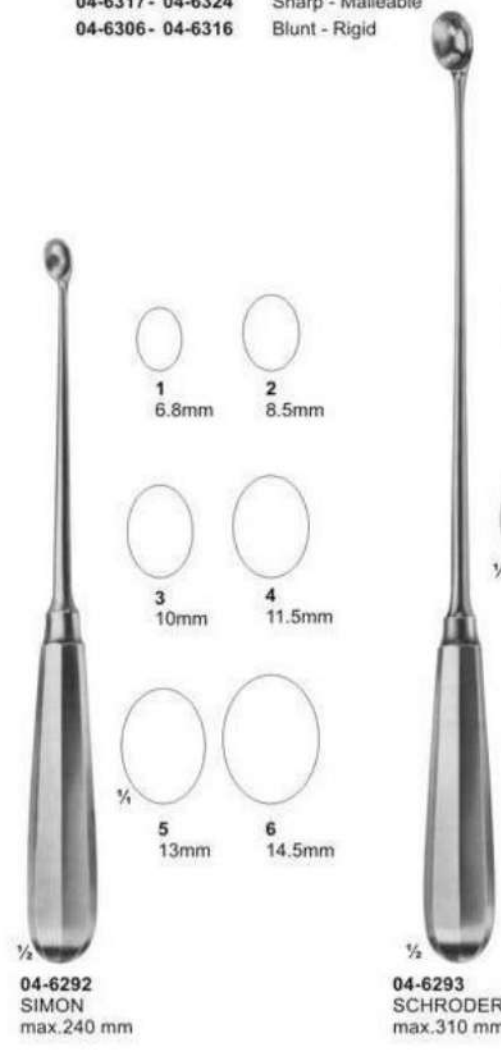
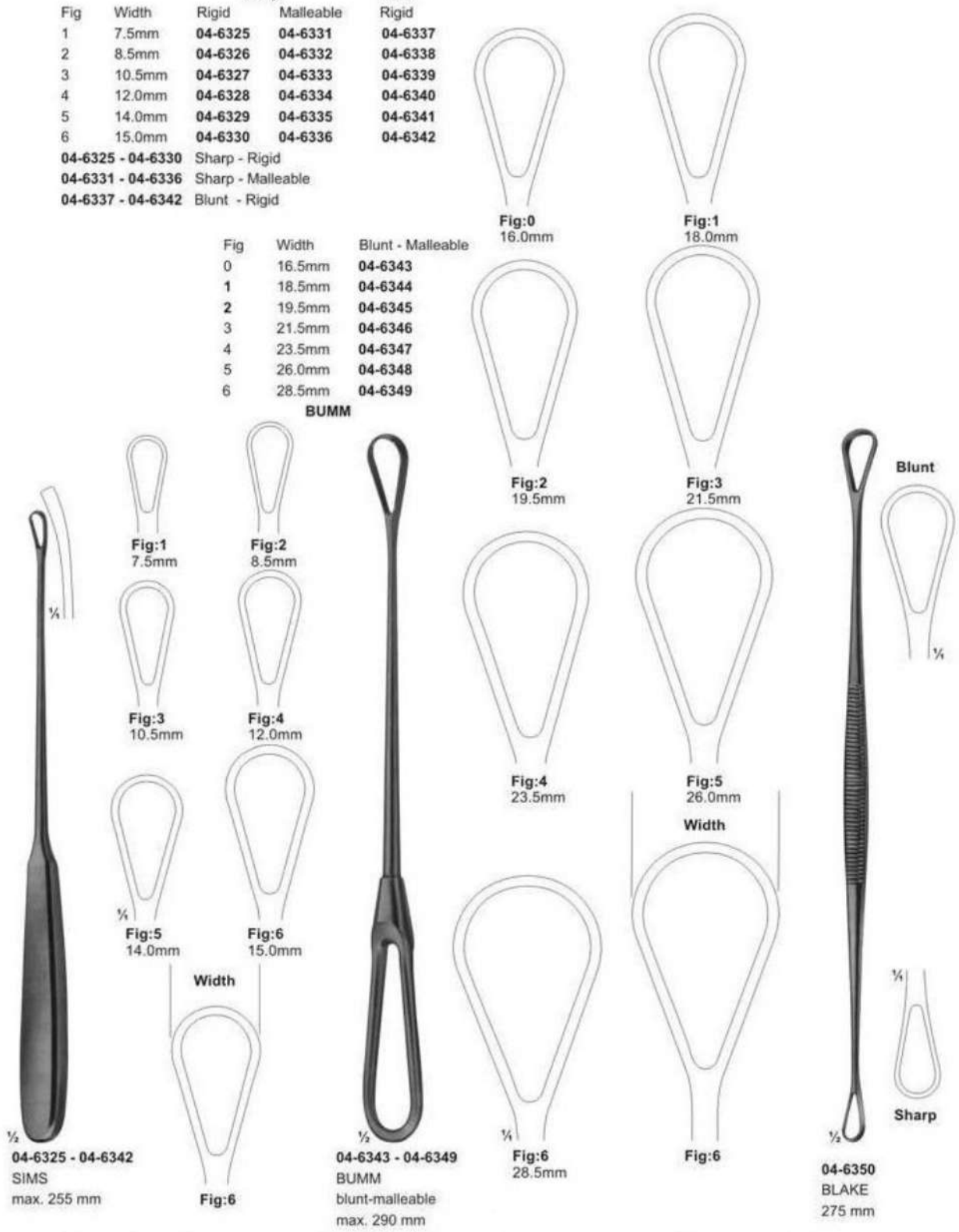

Fig	Width	Sharp		Blunt
		Rigid	Malleable	Rigid
1	7.5mm	04-6325	04-6331	04-6337
2	8.5mm	04-6326	04-6332	04-6338
3	10.5mm	04-6327	04-6333	04-6339
4	12.0mm	04-6328	04-6334	04-6340
5	14.0mm	04-6329	04-6335	04-6341
6	15.0mm	04-6330	04-6336	04-6342

04-6325 - 04-6330 Sharp - Rigid
 04-6331 - 04-6336 Sharp - Malleable
 04-6337 - 04-6342 Blunt - Rigid

Fig	Width	Blunt - Malleable
0	16.5mm	04-6343
1	18.5mm	04-6344
2	19.5mm	04-6345
3	21.5mm	04-6346
4	23.5mm	04-6347
5	26.0mm	04-6348
6	28.5mm	04-6349

BUMM



04-6325 - 04-6342
 SIMS
 max. 255 mm

04-6343 - 04-6349
 BUMM
 blunt-malleable
 max. 290 mm

04-6350
 BLAKE
 275 mm

Fig	Width	Sharp Malleable	Blunt Malleable
1	23.5mm	04-6354	04-6356
2	26.0mm		04-6357
3	28.5mm	04-6355	04-6358



04-6351
COLLIN
300 mm

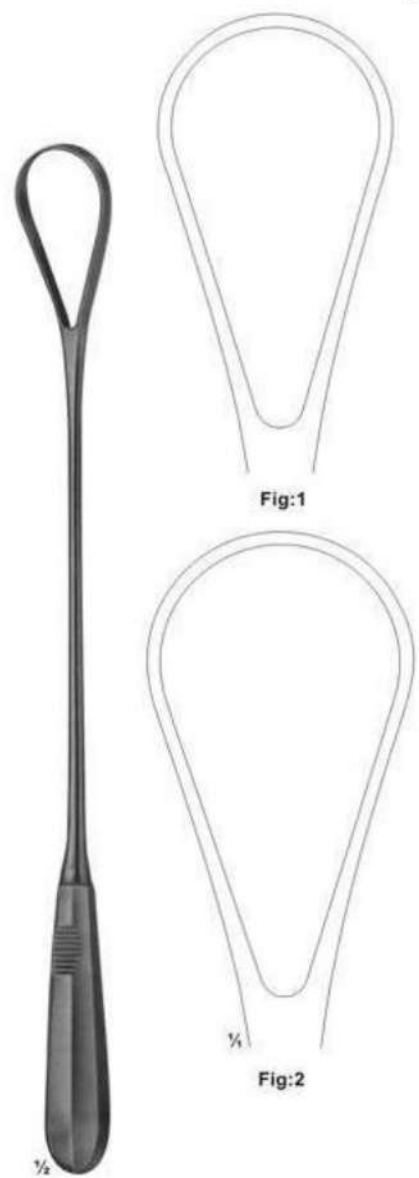

04-6352 - 04-6353
RECAMIER
blunt-rigid
max. 360 mm

Fig	Width	Blunt Rigid
1	34.5mm	04-6352
2	39.5mm	04-6353

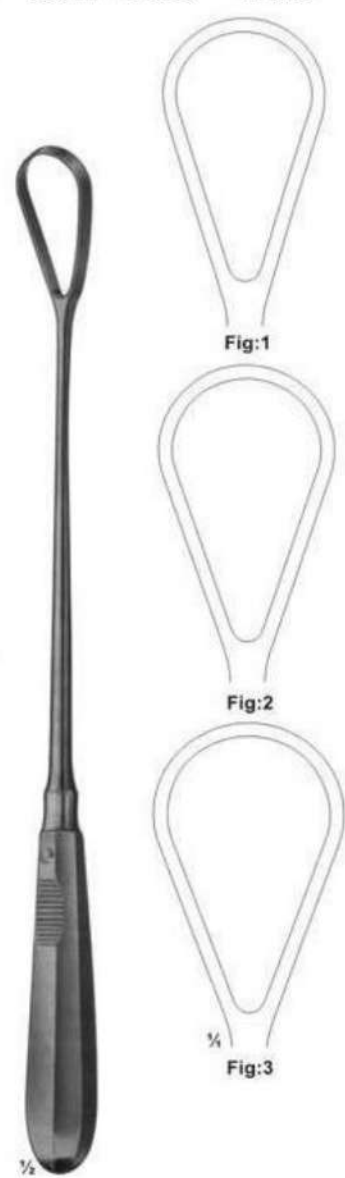

04-6354 - 04-6358
BUMM
max. 310 mm

Code	Sharp Malleable	Blunt Malleable
04-6354 - 04-6355	sharp-malleable	
04-6356 - 04-6358		blunt-malleable

04-6359 - 04-6364

Suction currettes, stainless steel, fitting hose connection.
Working tips are smoothly rounded off, therefore no danger of perforation.



(suitable for suction biopsy)
04-6359: diam 4 mm
04-6360: diam 6 mm
04-6361: diam 8 mm
04-6362: diam 10 mm
04-6363: diam 12 mm
04-6364: diam 14 mm

04-6365

Hose connection inside diam. 11 mm, curved, stainless steel.



The new connection between suction currette and hose connection, (**04-6365**) Guarantees quick changing and free turning of the suction currettes on the hose connection.

04-6366

Transparent suction hose 1.8 mm long, inside diam 11 mm, outside diam 16.5 mm can be sterilized in an autoclave at 1 bar overpressure (120 C)

04-6367

Strainer for tissues, plastic, for single use only, to be used for histopathological examination.





04-6368 diam 8 mm
 04-6369 diam 10 mm
 BOZEMANN-FRITSCH
 Uterine Flushing Tube
 350 mm



04-6371

04-6372

- 04-6370 SCHULZE Salpingograph, for utero-salpingography in wooden case, consisting of:
- 04-6371 Manometer only
- 04-6372 Connection only, without manometer
- 04-6373 Uterine cannula with tape without cone
- 04-6374 Cone only, small
- 04-6375 Cone only, medium
- 04-6376 Cone only, large
- 04-6377 Record syringe, 10CC, luer-lock mount.

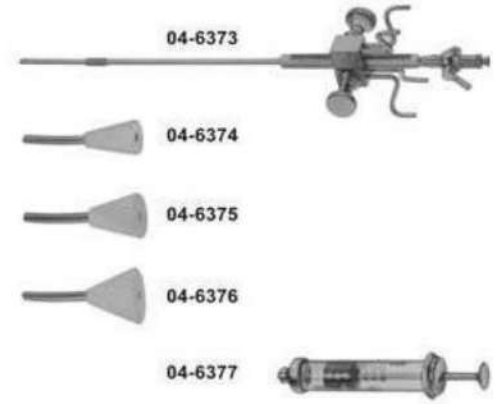

04-6373

04-6374

04-6375

04-6376

04-6377



04-6378 SCHULZE Salpingograph, equipment like(04-6370) but without manometer.



04-6379
THOLE
for internal and external measurements, graduated in centimeters



04-6380
DE LEE
graduated in centimeters and inches



04-6381
COLLIN
graduated in centimeters



04-6382
MARTIN
graduated in centimeters



04-6383
SCHNEIDER
graduated in centimeters

The additional straight arm can be replaced. The pelvimeter with straight arm is used for localisation of the portio vaginalis uteri and of vaginal metastasis.



04-6384
BREISKY
graduated in centimeters



04-6385
HERFF
membrane puncturing
forceps
255 mm



04-6386
IOWA
membrane puncturing
forceps
260 mm



04-6387
SCHUMACHER
Umbilical cord
scissors
155 mm



04-6388
Umbilical cord
scissors
105 mm

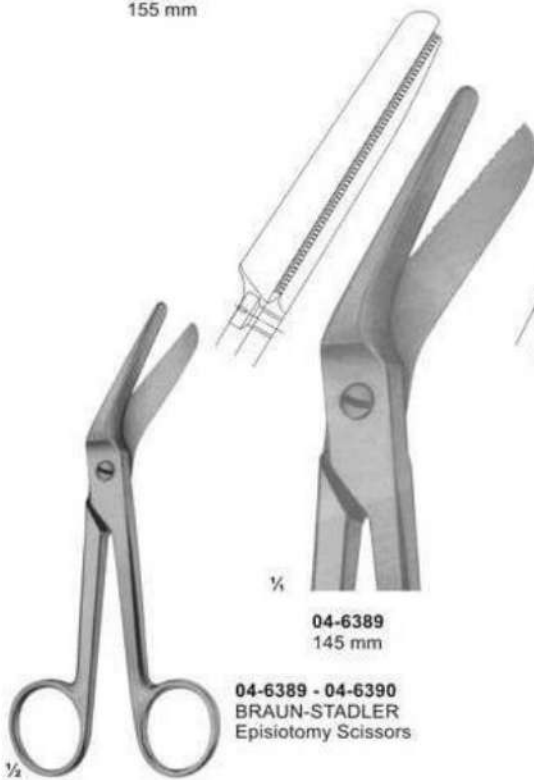

04-6389 - 04-6390
BRAUN-STADLER
Episiotomy Scissors

04-6389
145 mm

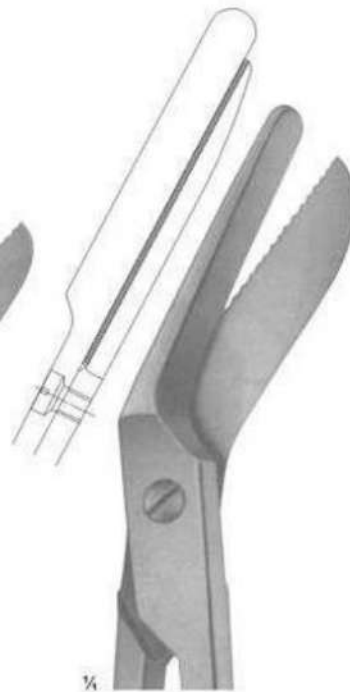

04-6390
200 mm

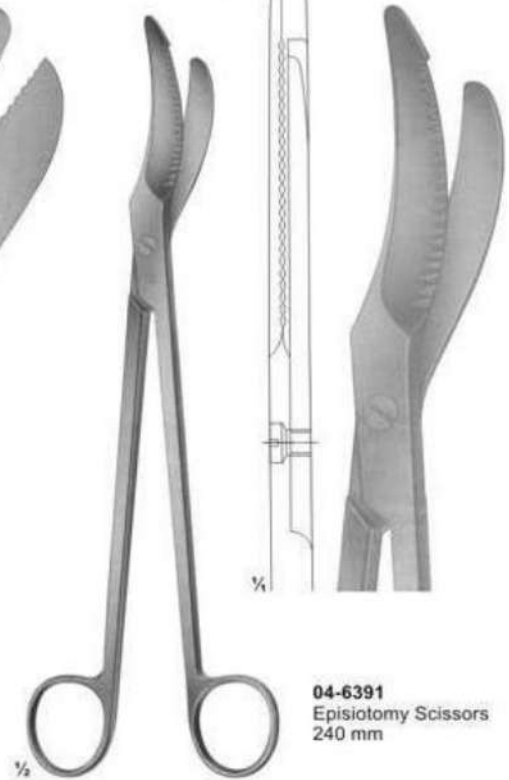

04-6391
Episiotomy Scissors
240 mm



04-6392
NAEGELE
355 mm



04-6393
NAEGELE
400 mm



04-6394
SIMPSON-BRAUN
305mm



1/2
04-6395
SIMPSON-BRAUN
350mm

For caesarean section



1/2
04-6396
SIMPSON
235mm

For caesarean section



1/2
04-6397
WRIGLEY
250 mm



04-6398
GREEN-ARMYTAGE
Caesarean section haemostatic
forceps, for edges of the transverse
incision in the lower segment
220 mm



04-6399
WILLETT
Scalp Flap forceps
185 mm



04-6400
GAUSS
Scalp Flap forceps
260 mm





04-6408
SAENGER
285 mm

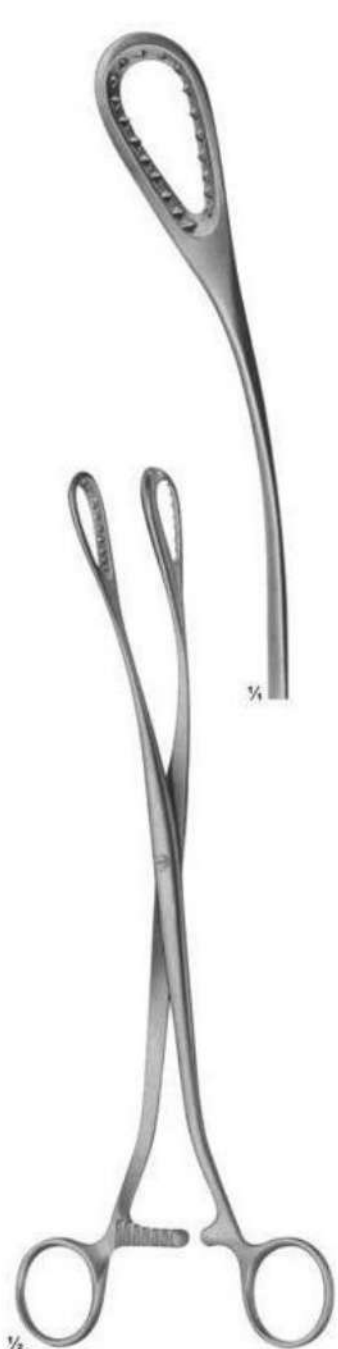

04-6409
SAENGER
265 mm



04-6410 - 04-6411
LEWKOWITZ
245 mm

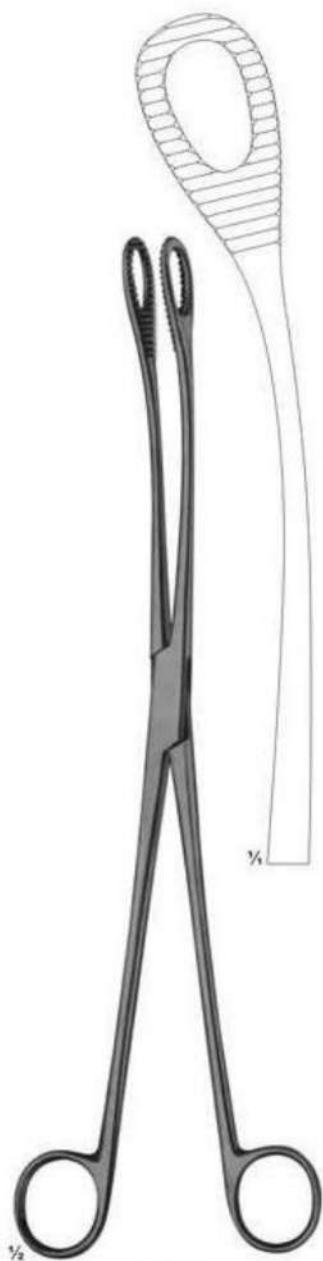

04-6412
KELLY
320mm



04-6413
SMELLIE
Perforator
270mm

1 jaws fenestrated



04-6414
BRAUN
Cranioclast
420mm

Section - 05

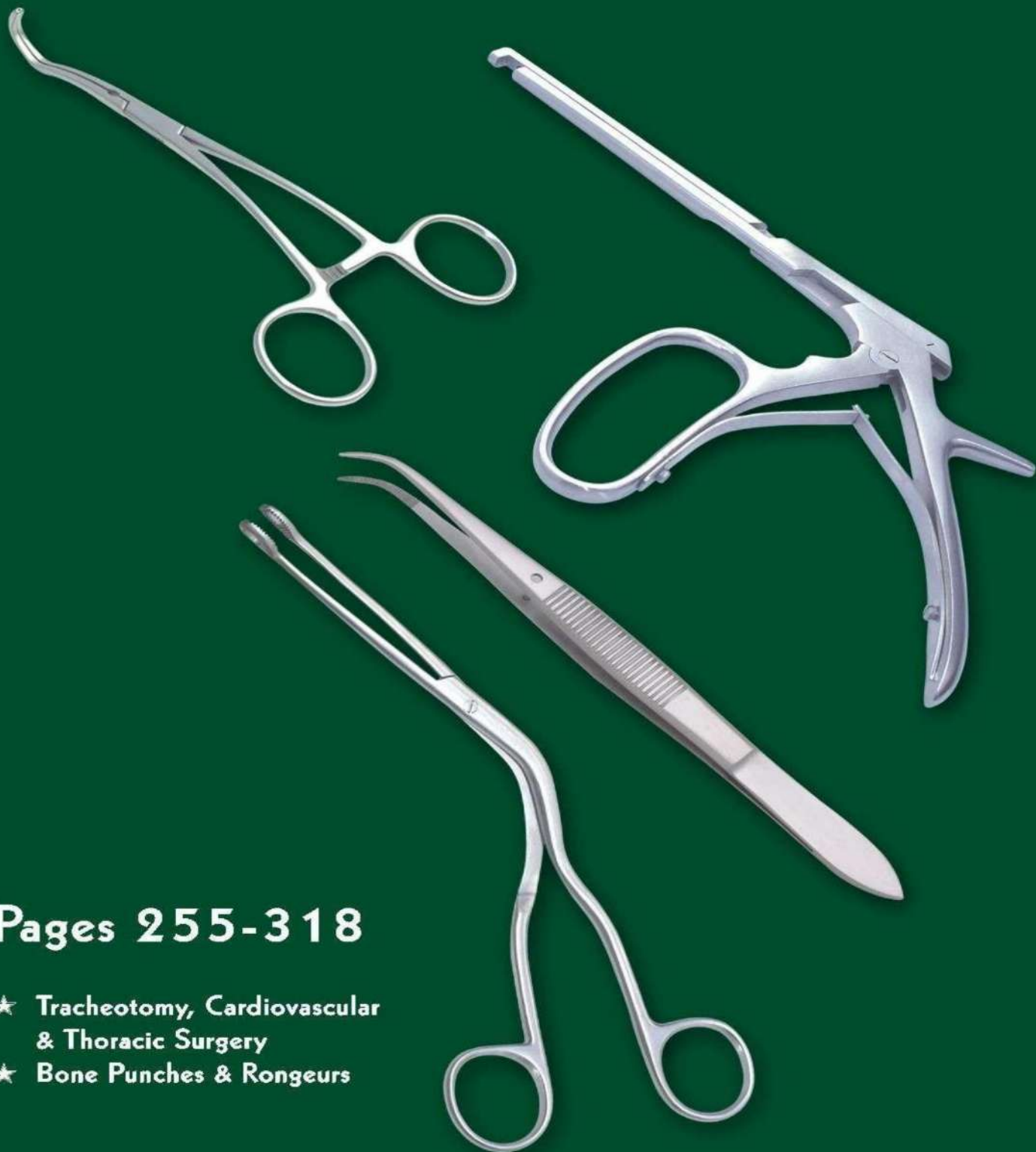

Pages 255-318

- ★ Tracheotomy, Cardiovascular & Thoracic Surgery
- ★ Bone Punches & Rongeurs

Fig.	0	1	2	3	4	5	6	7	8	9	10
∅ mm	4	5	6	7	8	9	10	11	12	13	14
Charr./Fr.	12	15	18	21	24	27	30	33	36	39	42



05-7001
UECKERMANN-DENKER
Cryothyrotomy trocar
with silver cannula
130mm

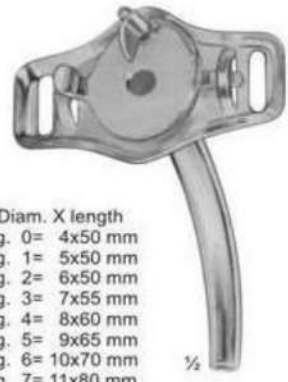

Diam. X length
05-7002 Fig. 0= 4x50 mm
05-7003 Fig. 1= 5x50 mm
05-7004 Fig. 2= 6x50 mm
05-7005 Fig. 3= 7x55 mm
05-7006 Fig. 4= 8x60 mm
05-7007 Fig. 5= 9x65 mm
05-7008 Fig. 6= 10x70 mm
05-7009 Fig. 7= 11x80 mm
05-7010 Fig. 8= 12x85 mm
05-7011 Fig. 9= 13x90 mm
05-7012 Fig. 10=14x90 mm

05-7002 - 05-7012
LUER
German silver



05-7013 - 05-7022
JACKSON
German Silver

Diam. X length
05-7013 Fig. 0= 4x50 mm
05-7014 Fig. 1= 5x48 mm
05-7015 Fig. 2= 6x58 mm
05-7016 Fig. 3= 7x70 mm
05-7017 Fig. 4= 8x78 mm
05-7018 Fig. 5= 9x84 mm
05-7019 Fig. 6= 10x84 mm
05-7020 Fig. 7= 11x86 mm
05-7021 Fig. 8= 12x88 mm
05-7022 Fig. 9= 13x90 mm



Diam. X length **05-7023 - 05-7032**
JACKSON
Stainless Steel

05-7023 Fig. 1= 5x48 mm
05-7024 Fig. 2= 6x58 mm
05-7025 Fig. 3= 7x70 mm
05-7026 Fig. 4= 8x78 mm
05-7027 Fig. 5= 9x84 mm
05-7028 Fig. 6= 10x84 mm
05-7029 Fig. 7= 11x86 mm
05-7030 Fig. 8= 12x88 mm
05-7031 Fig. 9= 13x90 mm
05-7032 Fig. 10= 14x90 mm

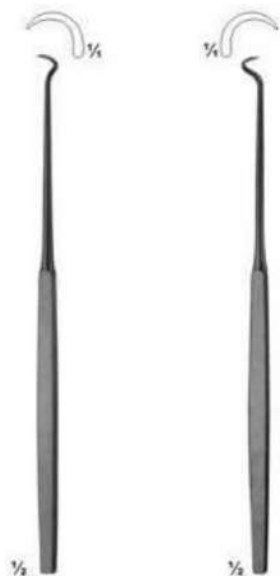

05-7033
BOSE
165 mm

05-7034
BOSE
165 mm



05-7035
sharp



05-7036
blunt



05-7037
blunt



05-7038
FINSEN
50 mm



05-7039
FINSEN
70 mm



05-7040
TROUSSEAU
120 mm



05-7041
LABORDE
125 mm



05-7042
LABORDE
strong pattern
135 mm



05-7043
Cleaning Brush
for tracheal tubes
285 mm

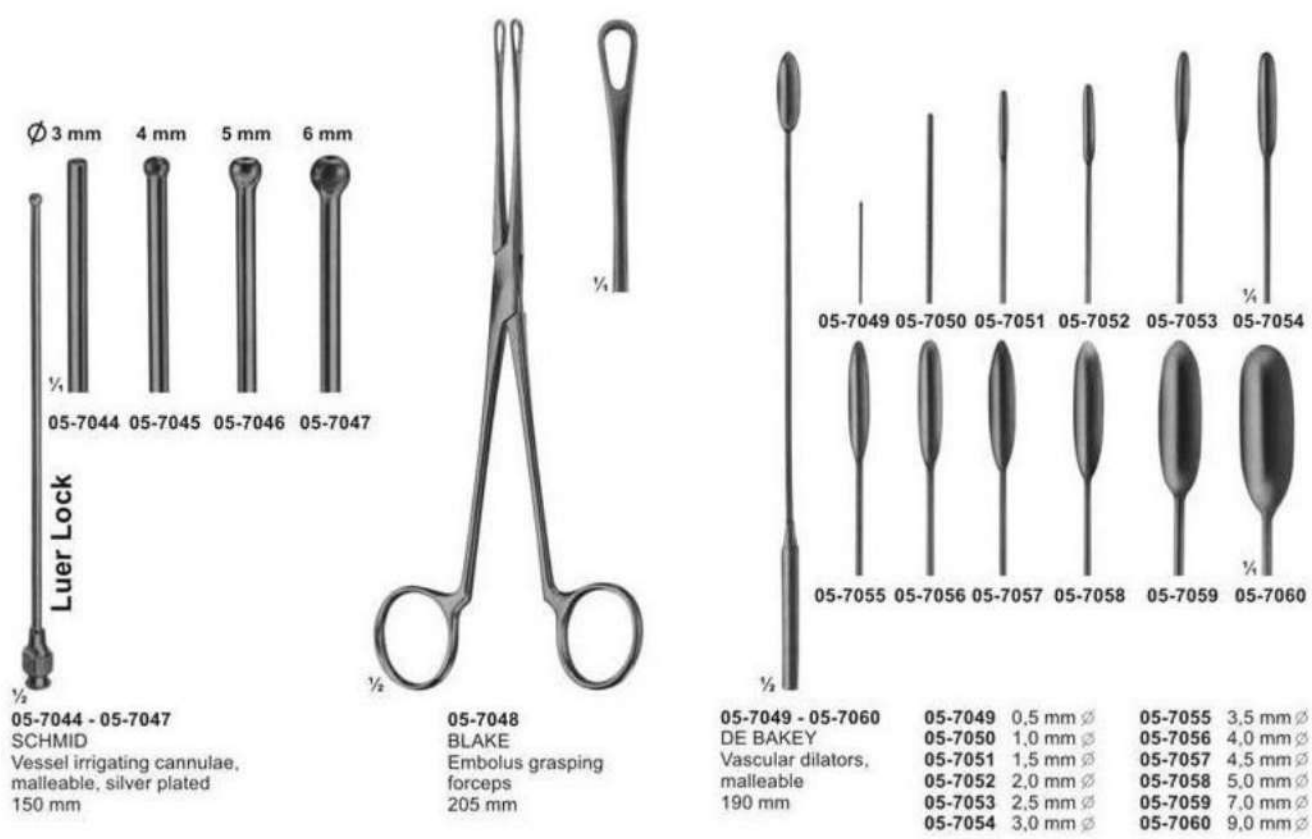

Ø 3 mm 4 mm 5 mm 6 mm
 05-7044 05-7045 05-7046 05-7047

Luer Lock
 05-7044 - 05-7047
 SCHMID
 Vessel irrigating cannulae,
 malleable, silver plated
 150 mm

05-7048
 BLAKE
 Embolus grasping
 forceps
 205 mm

05-7049 05-7050 05-7051 05-7052 05-7053 05-7054
 05-7055 05-7056 05-7057 05-7058 05-7059 05-7060

05-7049	0,5 mm Ø	05-7055	3,5 mm Ø
05-7050	1,0 mm Ø	05-7056	4,0 mm Ø
05-7051	1,5 mm Ø	05-7057	4,5 mm Ø
05-7052	2,0 mm Ø	05-7058	5,0 mm Ø
05-7053	2,5 mm Ø	05-7059	7,0 mm Ø
05-7054	3,0 mm Ø	05-7060	9,0 mm Ø

05-7049 - 05-7060
 DE BAKEY
 Vascular dilators,
 malleable
 190 mm

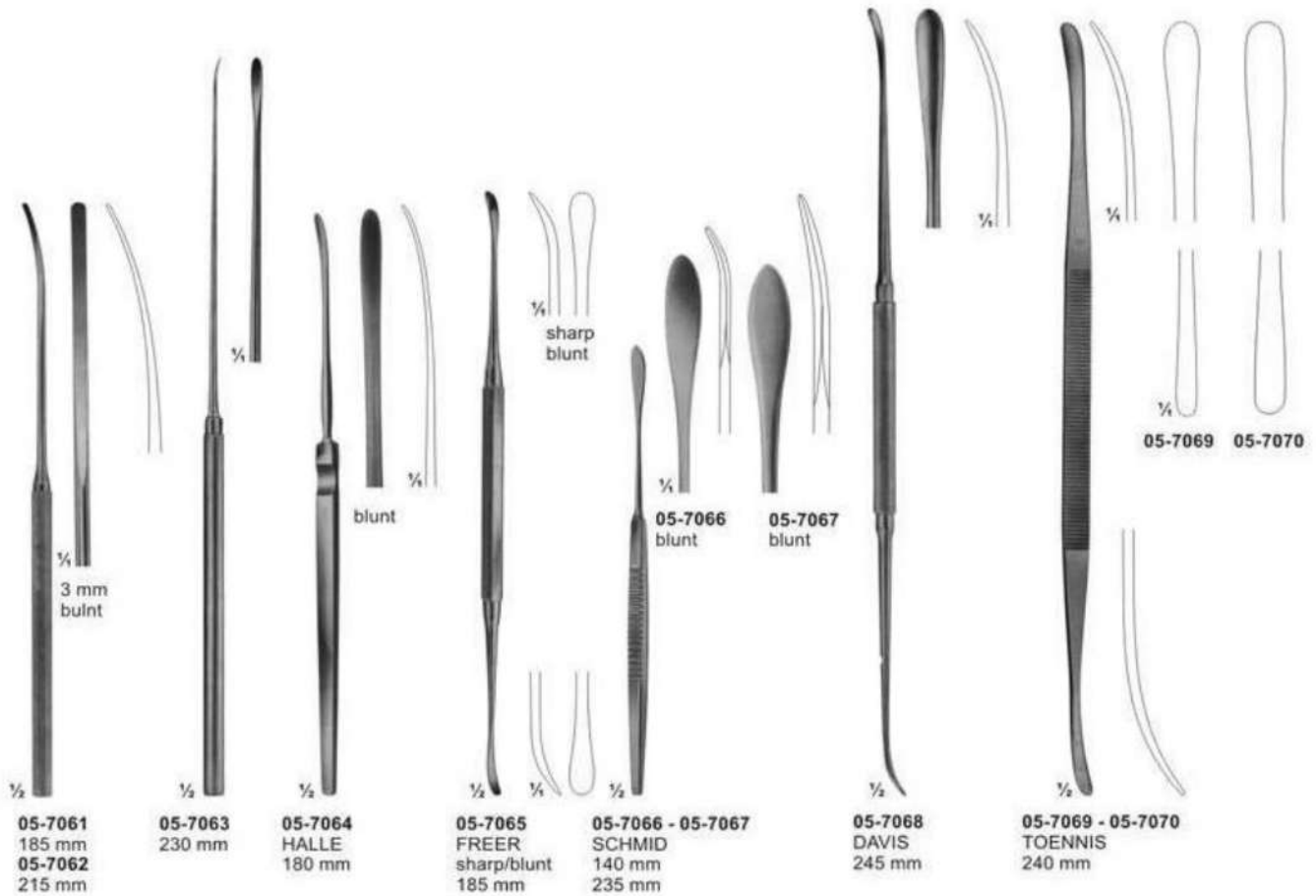

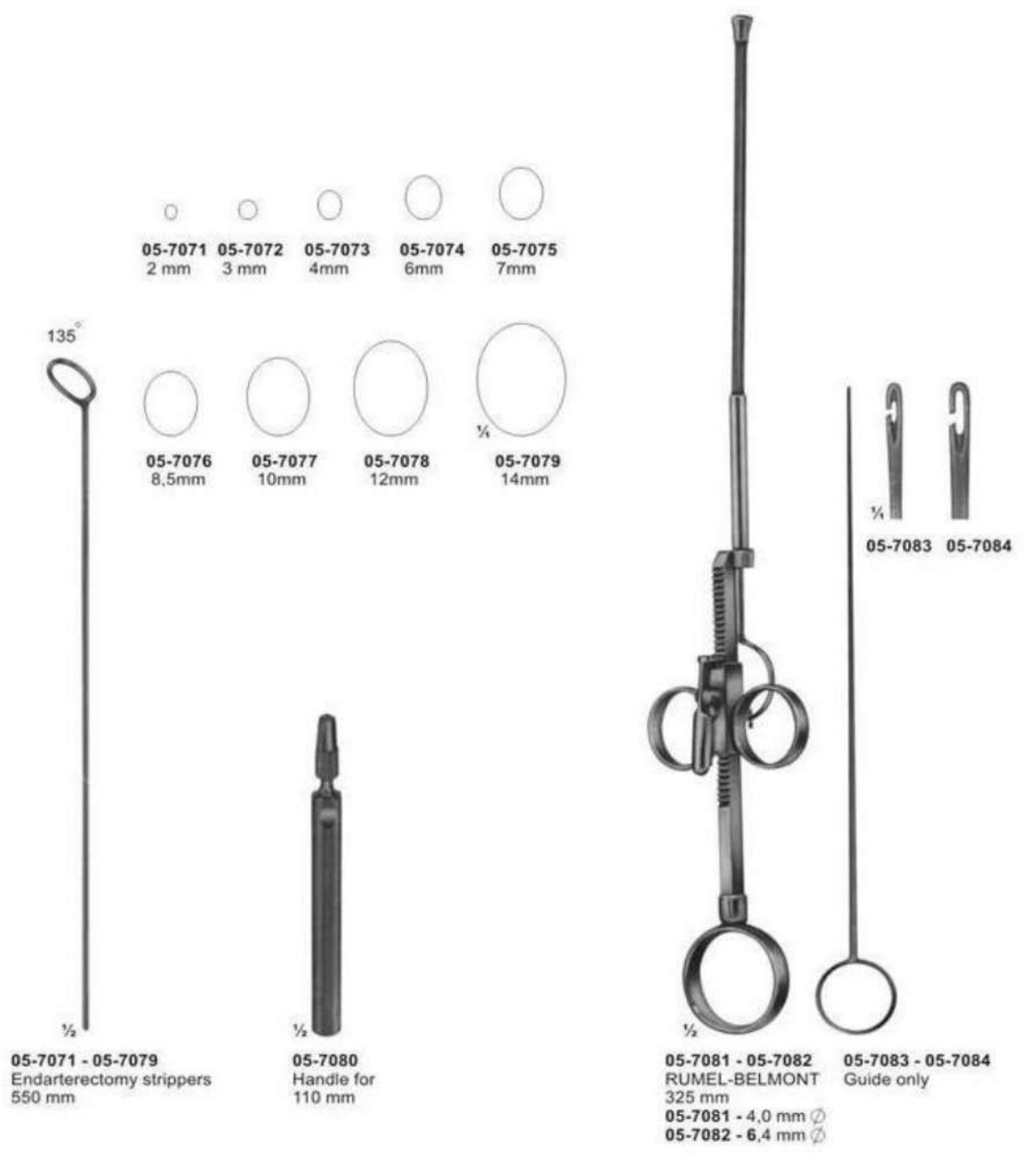

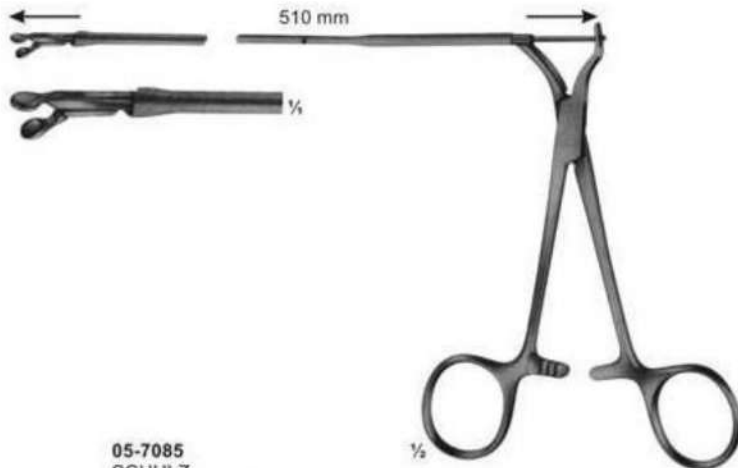

**05-7085
SCHULZ**
Bioptome, with flexible Shaft, 510 mm long,
with round jaws 3 mm diam.

Biopsy forceps, for biopsy from the right atrium
through cava jugularis, prior to heart implantations.

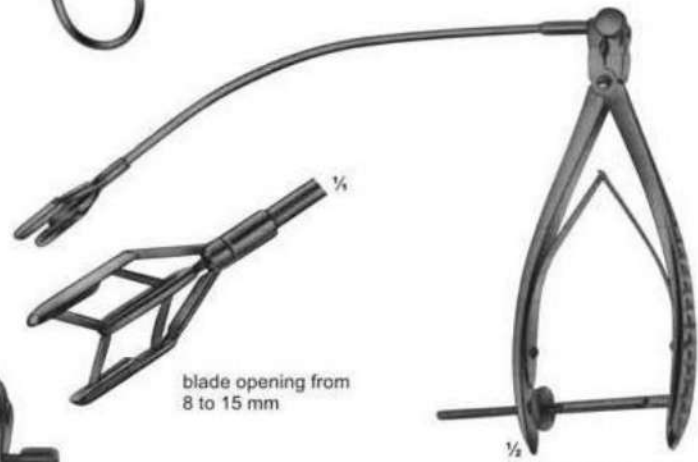

**05-7087
COOLEY**
Dilator for
mitral valve
for children

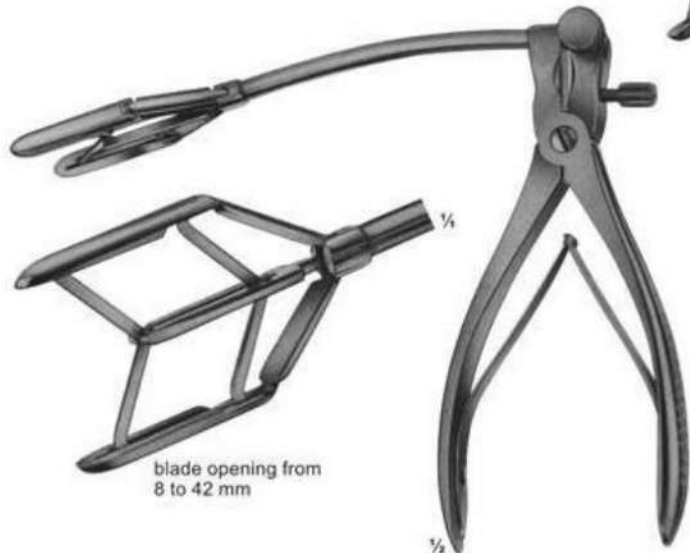

**05-7086
TUBBS**
Dilator for
mitral valve

blade opening from
8 to 42 mm

blade opening from
8 to 15 mm

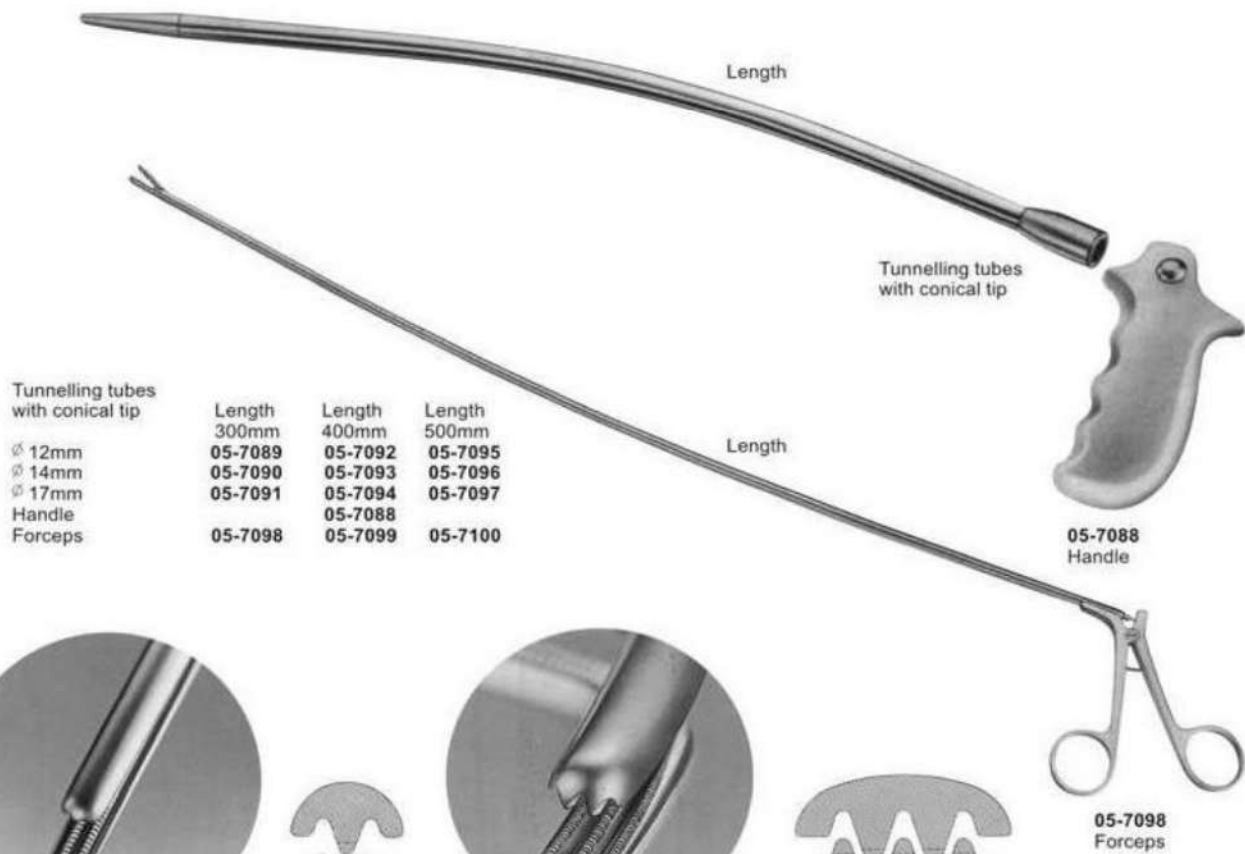

Tunnelling tubes with conical tip	Length 300mm	Length 400mm	Length 500mm
∅ 12mm	05-7089	05-7092	05-7095
∅ 14mm	05-7090	05-7093	05-7096
∅ 17mm	05-7091	05-7094	05-7097
Handle	05-7098	05-7088	05-7100
Forceps			



DE BAKEY
05-7101
1 : 2 rows of teeth



DE BAKEY
05-7102
2 : 3 rows of teeth

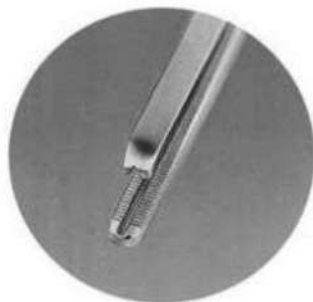
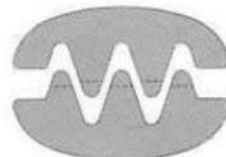

COOLEY
05-7103
2 : 2 rows of teeth

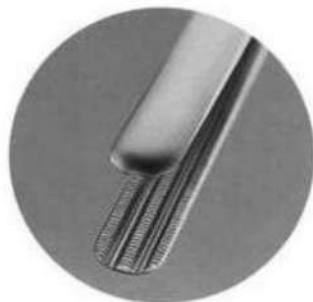

DARDIK
05-7104
2 : 3 rows of teeth





05-7105
Width of jaws 1.2 mm
Length 150mm

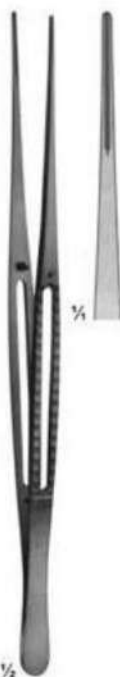

05-7106
Width 1,5 mm
Lenght 200 mm



05-7107
Width 1,5 mm
Lenght 240 mm



05-7108
Width 1,5 mm
Lenght 300 mm

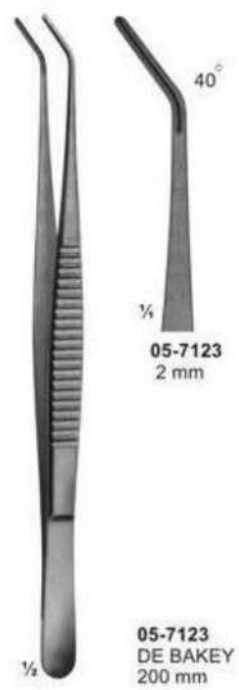
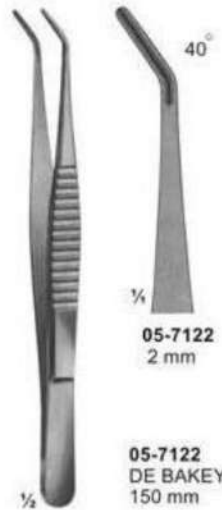
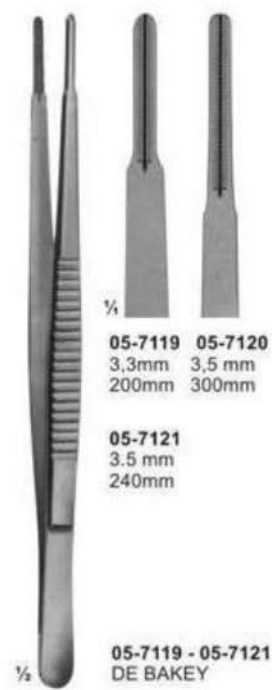
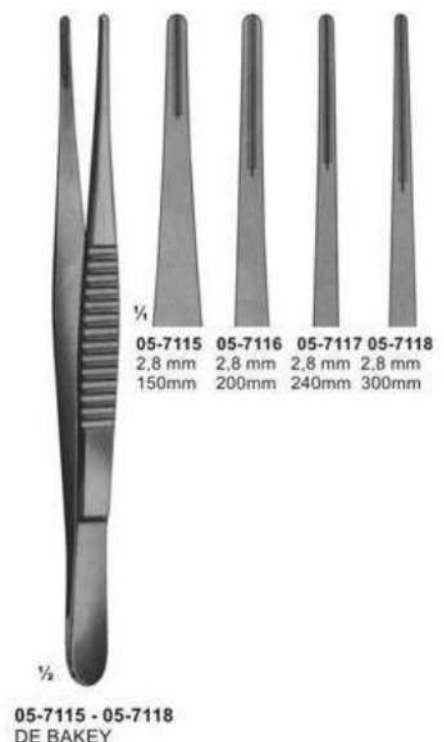
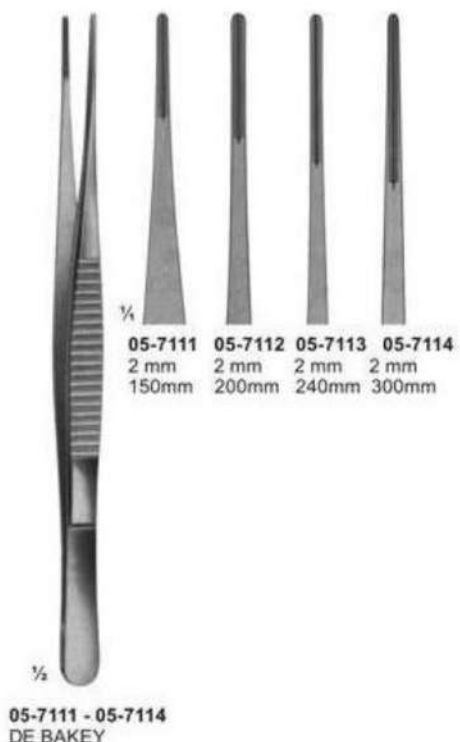
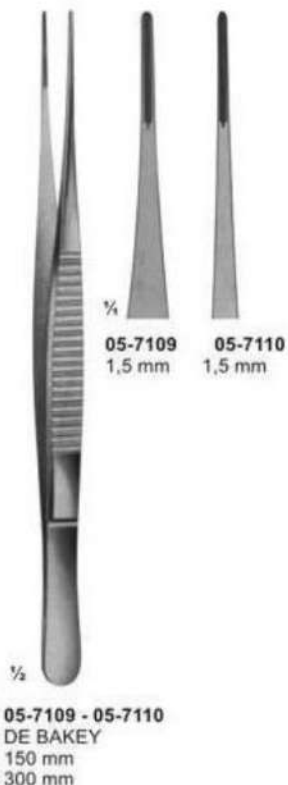



05-7124
DE-BAKEY
straight
130 mm



05-7125
DE-BAKEY
curved jaws
125 mm

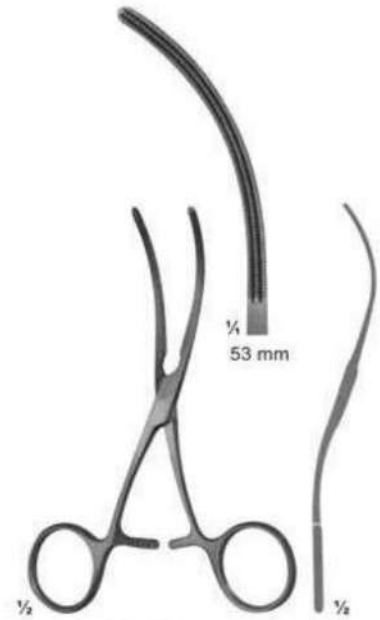

05-7126
DE-BAKEY
S-shaped curved
125 mm

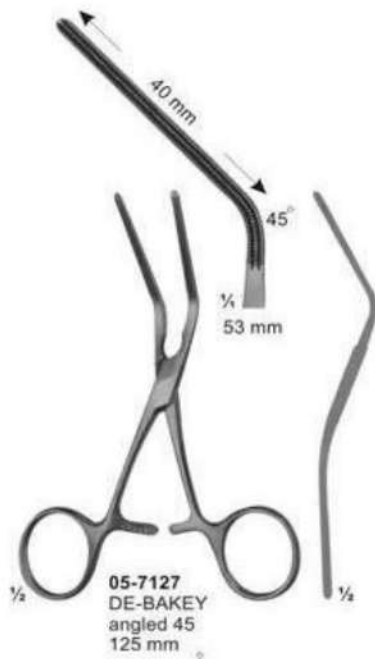

05-7127
DE-BAKEY
angled 45
125 mm

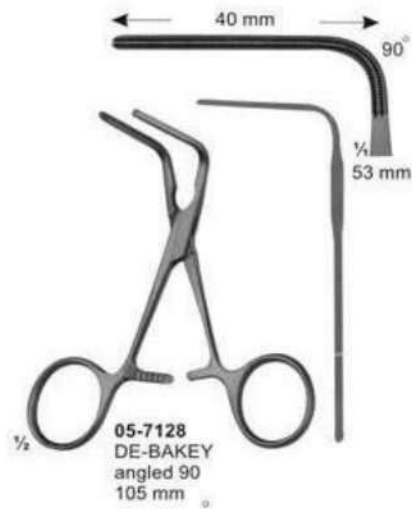

05-7128
DE-BAKEY
angled 90
105 mm

graduated



1/4

05-7129 - 05-7132
CASTANEDA

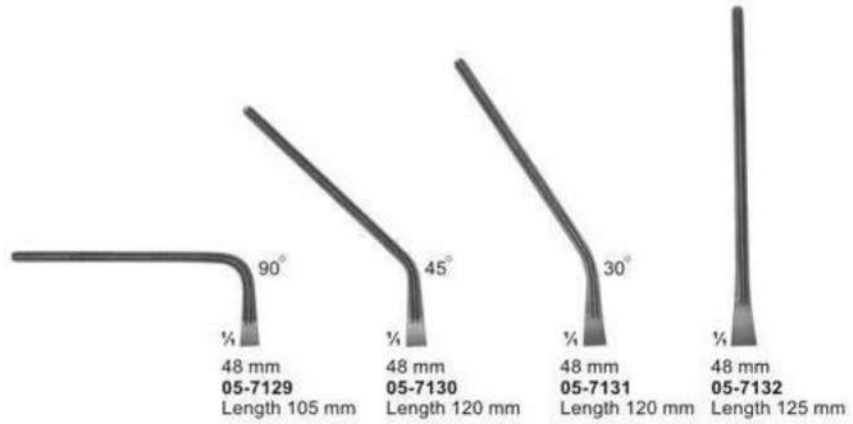

graduated



1/4

05-7133 - 05-7136
CASTANEDA

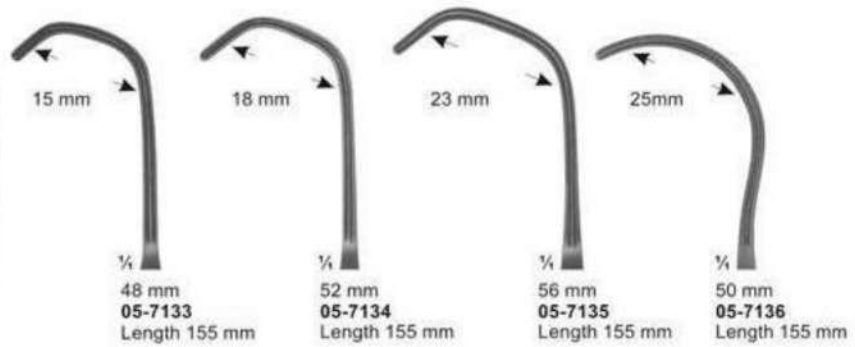

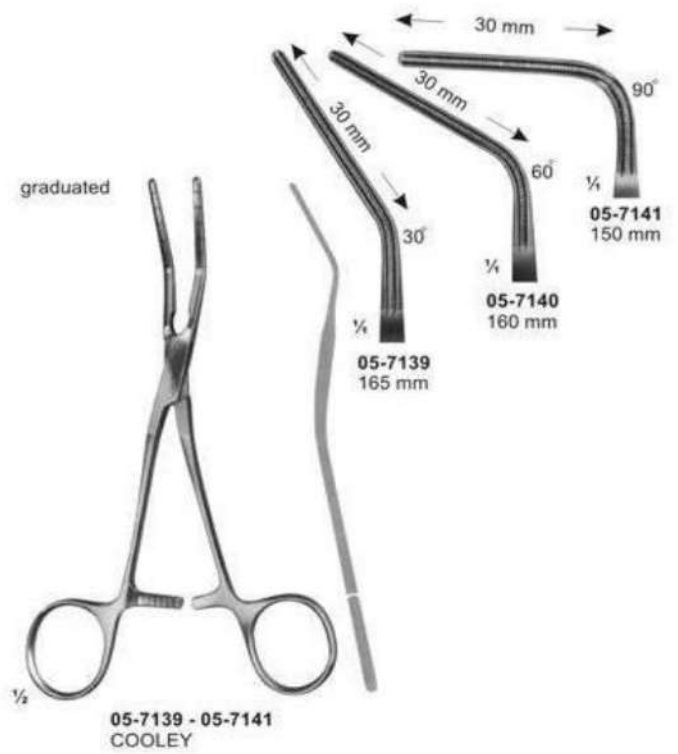
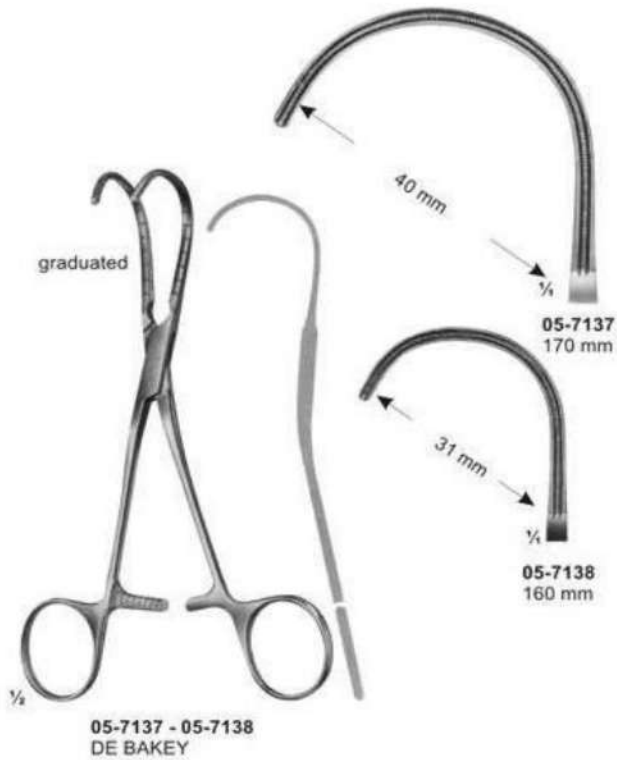

Mosquito Forceps

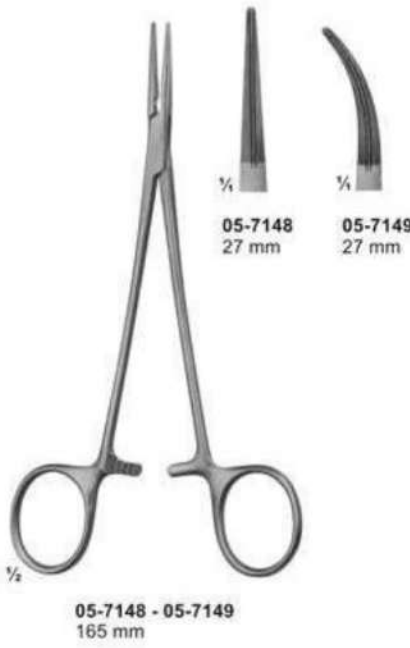

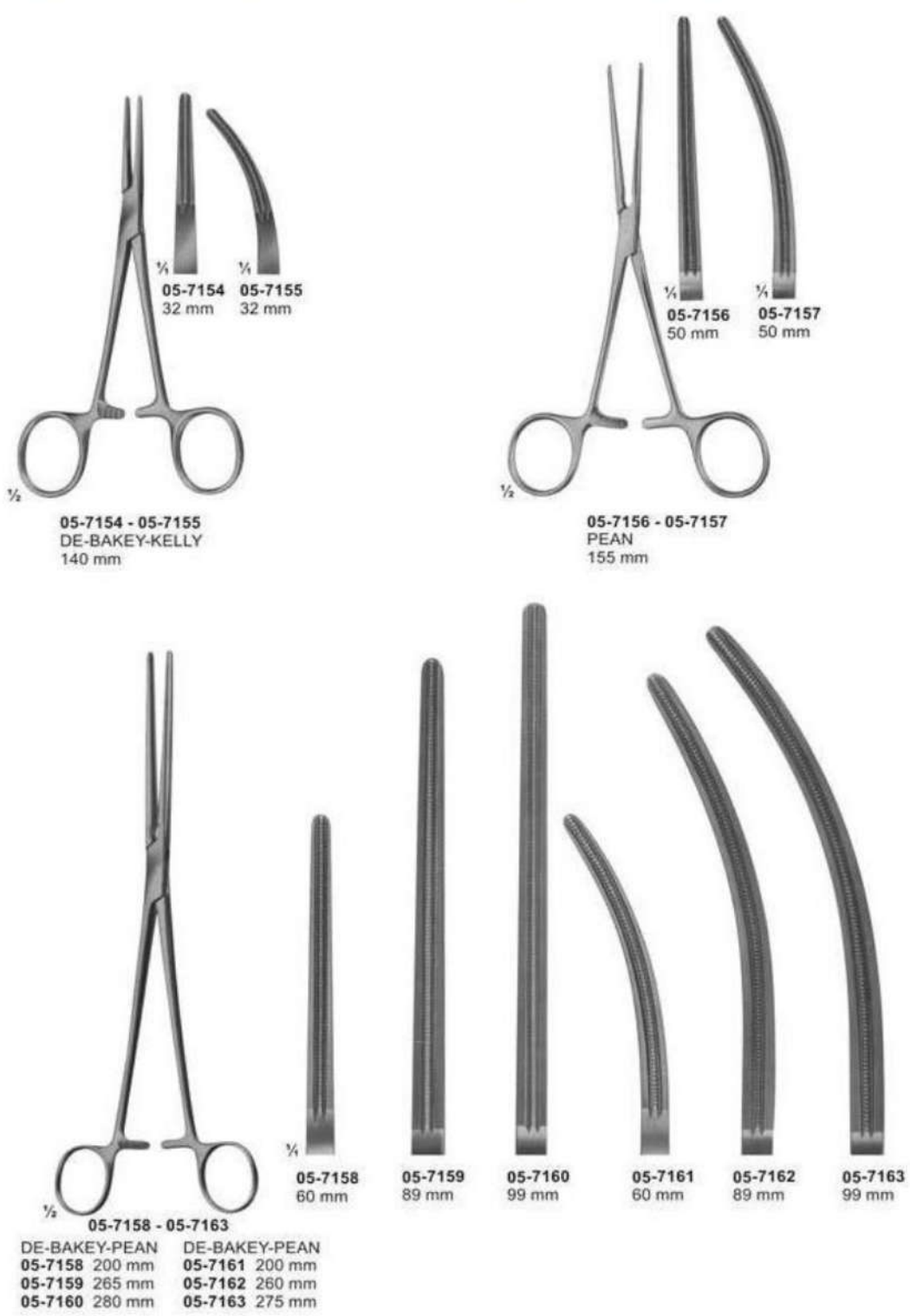



05-7164
DE-BAKEY-MIXTER
285 mm

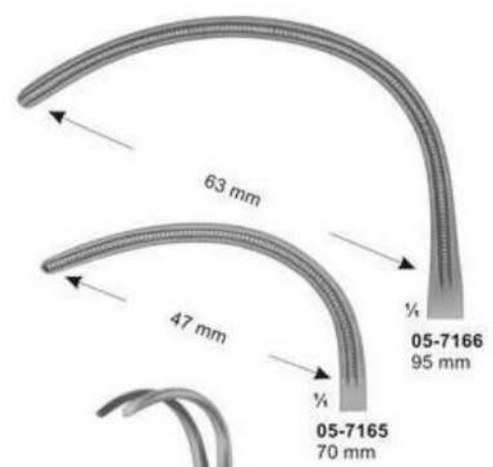

05-7165 - 05-7166
GLOVER
05-7165 195mm
05-7166 210mm



05-7167
GLOVER
220 mm

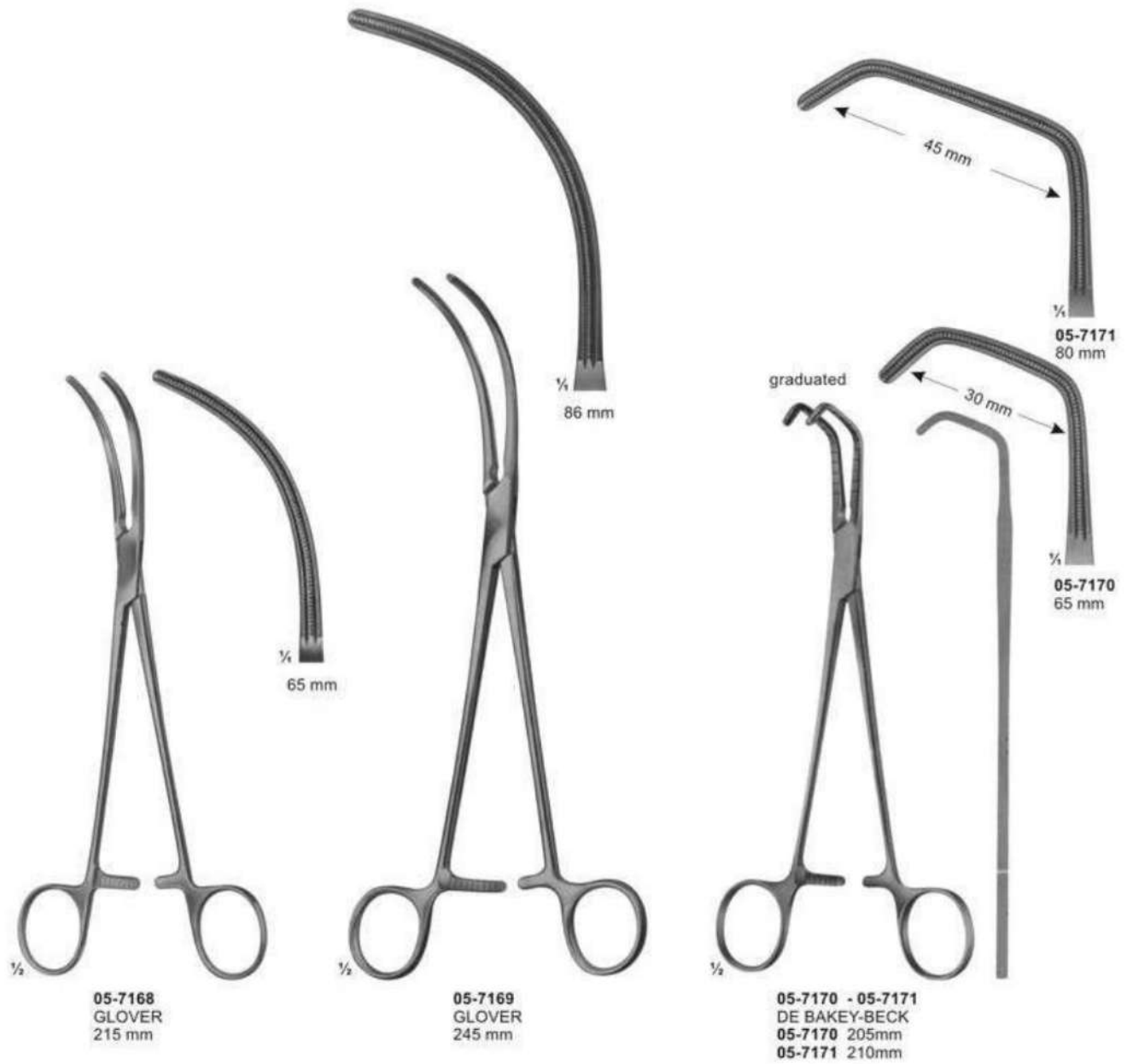

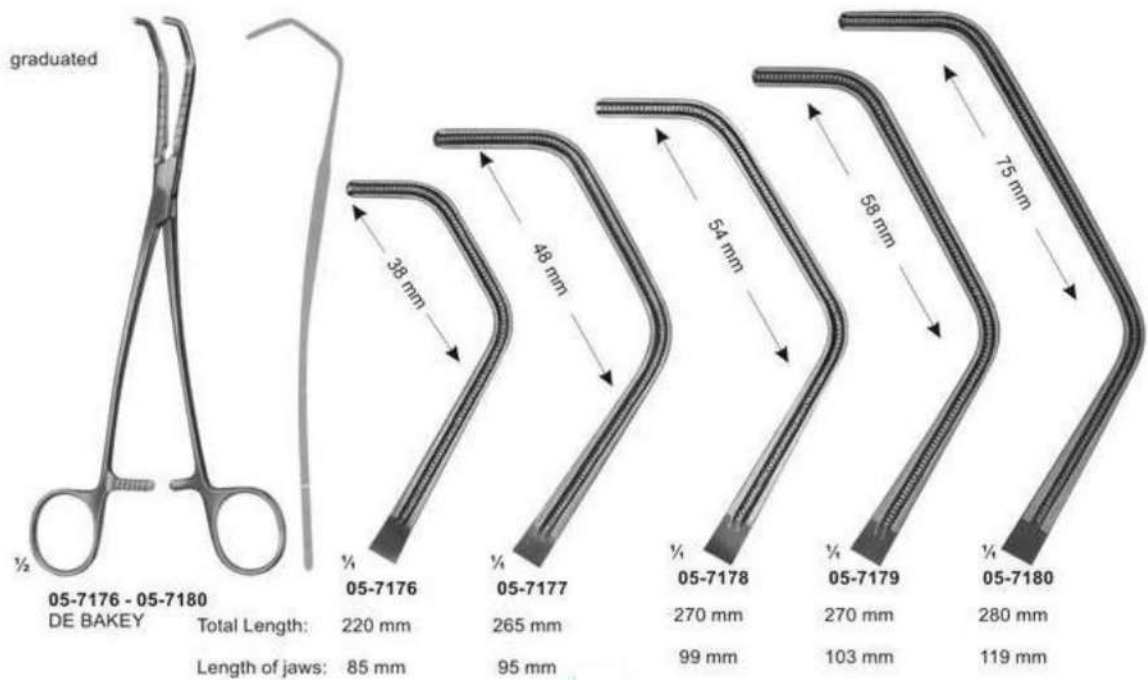
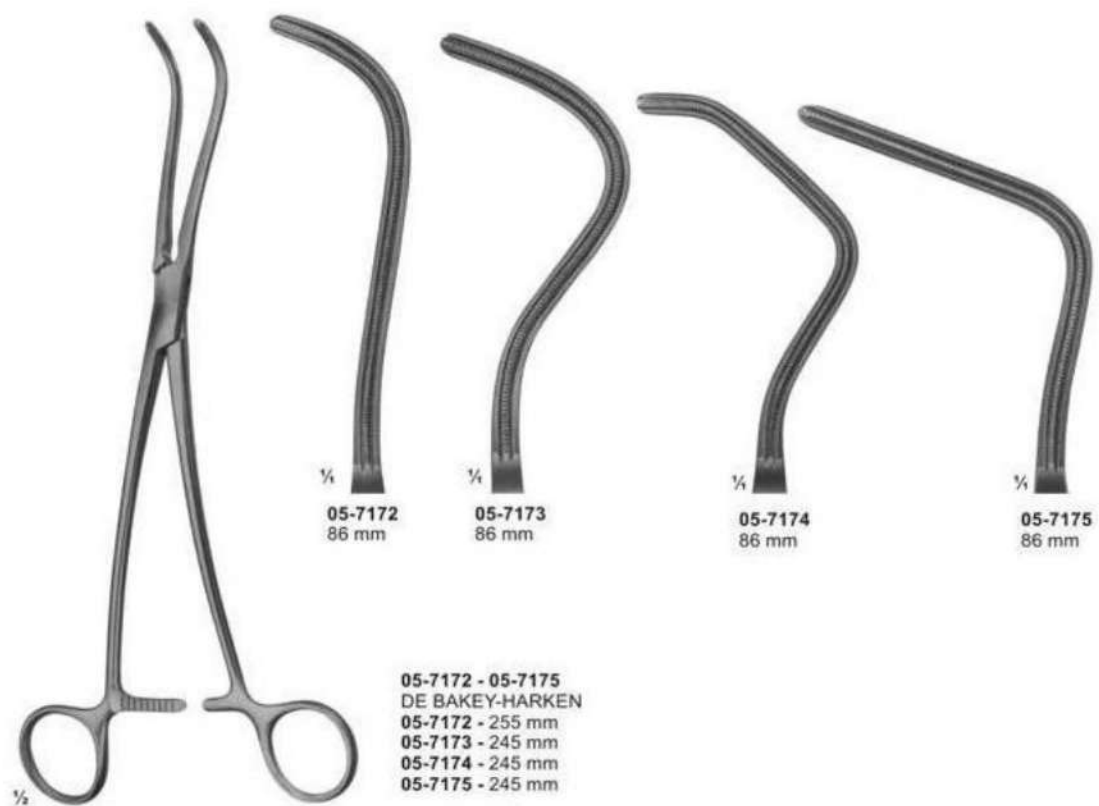



05-7181 - 05-7183
DE BAKEY-SATINSKY

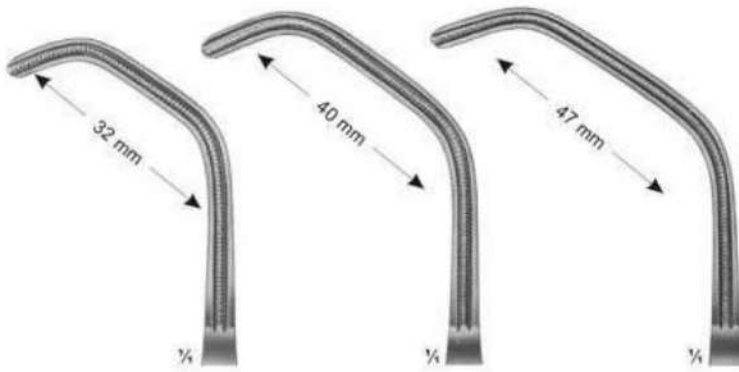

05-7181
68 mm
Length 235mm

05-7182
76 mm
Length 240mm

05-7183
84 mm
Length 245mm



05-7184 - 05-7185
DE BAKEY
05-7184 170mm
05-7185 165mm



05-7184
50 mm

05-7185
50 mm



05-7186
DE BAKEY
165 mm



50 mm





05-7196
DE BAKEY
190 mm



05-7197
DE BAKEY
200 mm

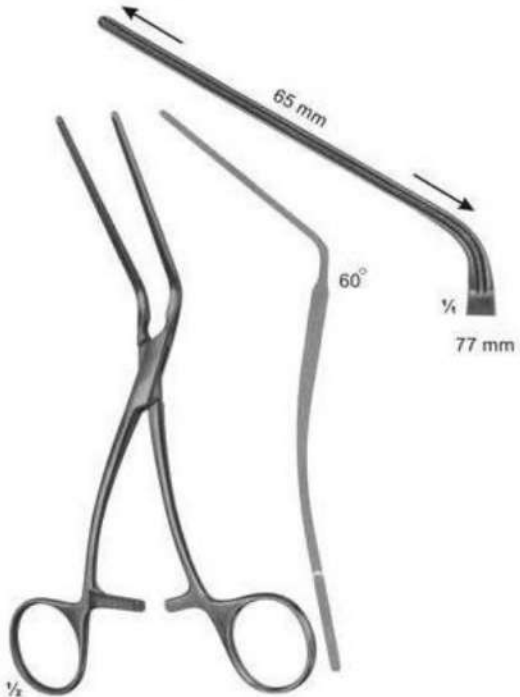

05-7198
DE BAKEY
180 mm



05-7199 - 05-7200
LELAND-JONES
190 mm





05-7204 78 mm
05-7205 88 mm
05-7206 98 mm

05-7204 - 05-7206
DICK
05-7204 255mm
05-7205 265mm
05-7206 275mm



05-7207
MORRIS
175 mm



05-7208
DE BAKEY (Morris Modif)
240 mm



05-7209
LEES
220 mm



05-7210
LEES
245 mm

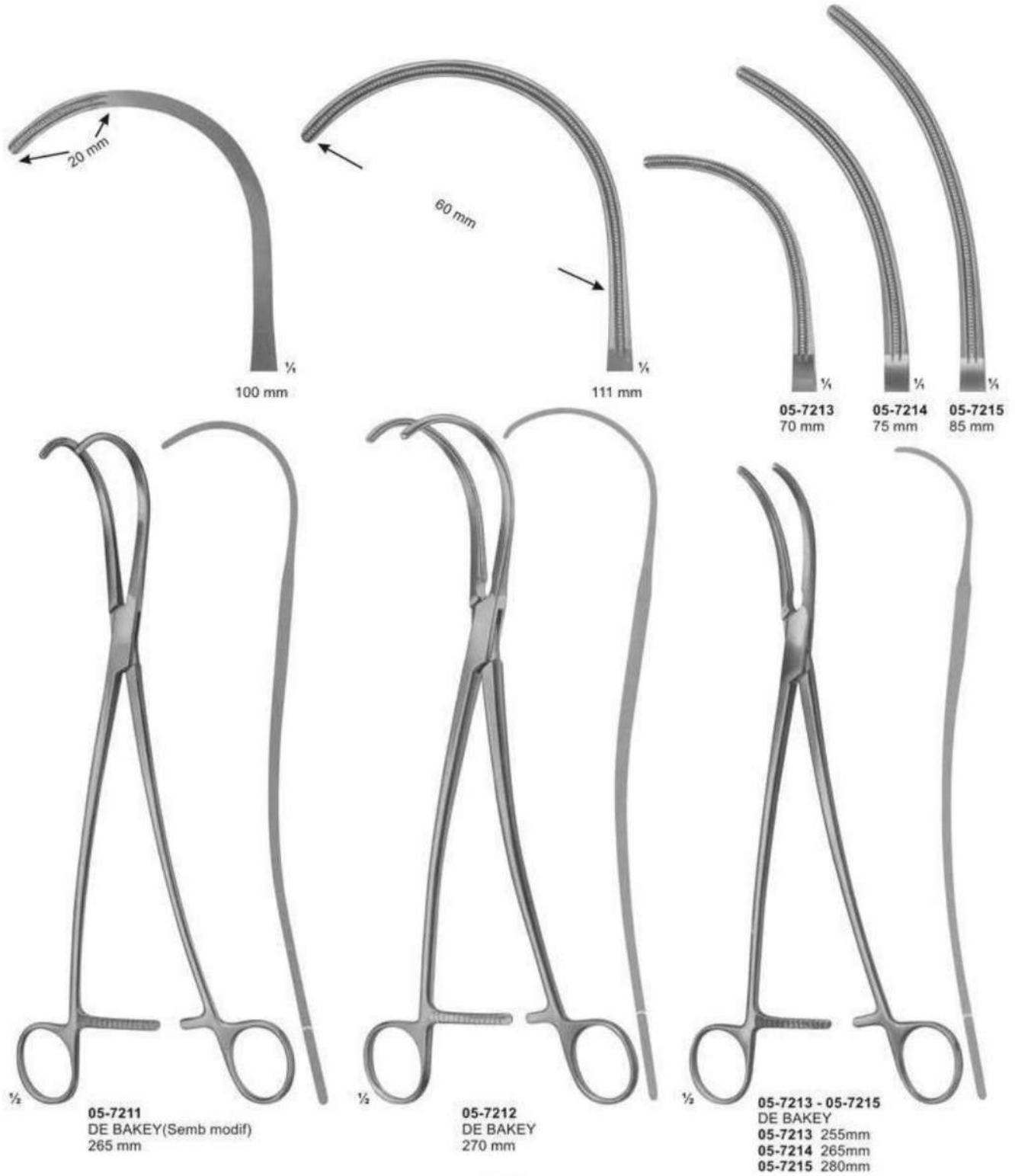



2.3 Teeth Rows

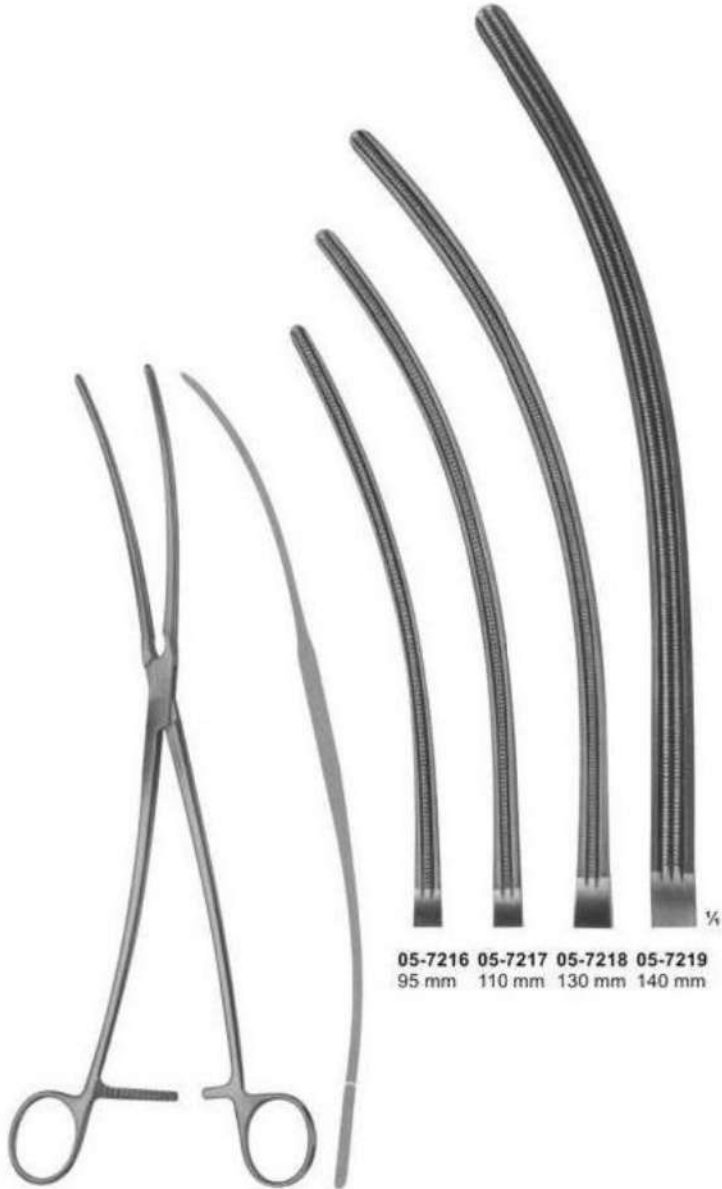

05-7216 05-7217 05-7218 05-7219
95 mm 110 mm 130 mm 140 mm

05-7216 - 05-7219
DE BAKEY
05-7216 250mm
05-7217 300mm
07-7218 315mm
07-7219 330mm



115 mm

05-7220
DE BAKEY
300 mm



05-7221
DIETRICH
210 mm

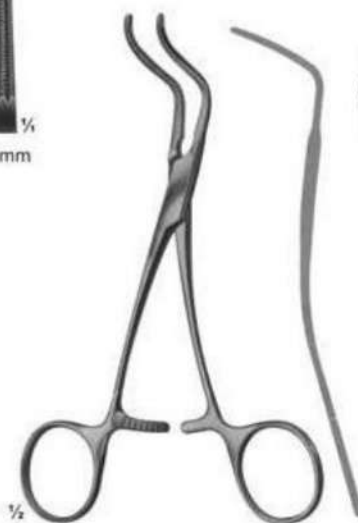

05-7222
SUBRAMANIAN(Modif)
155 mm

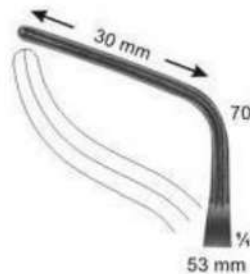

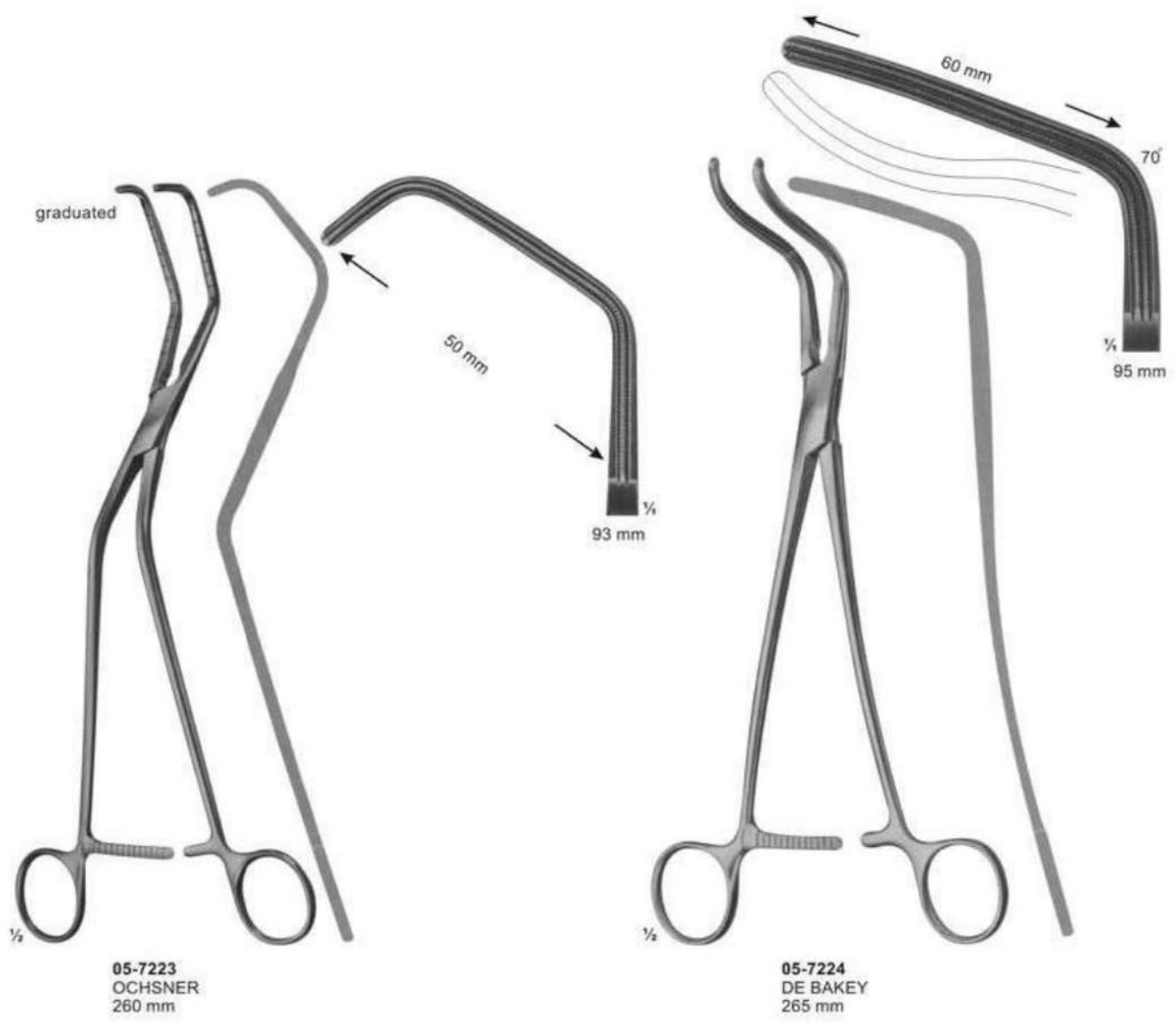

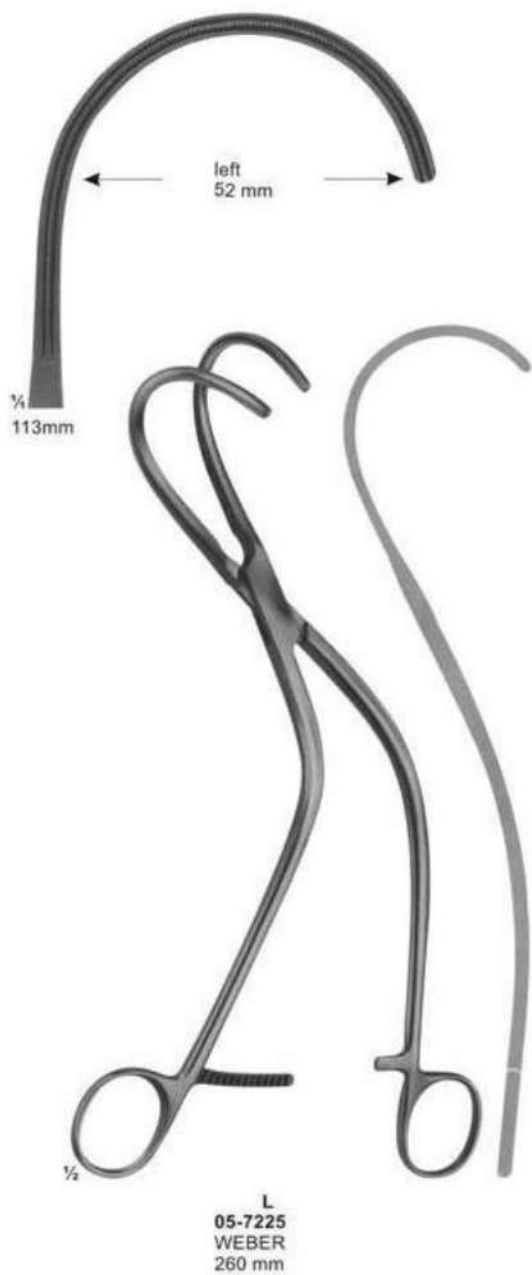

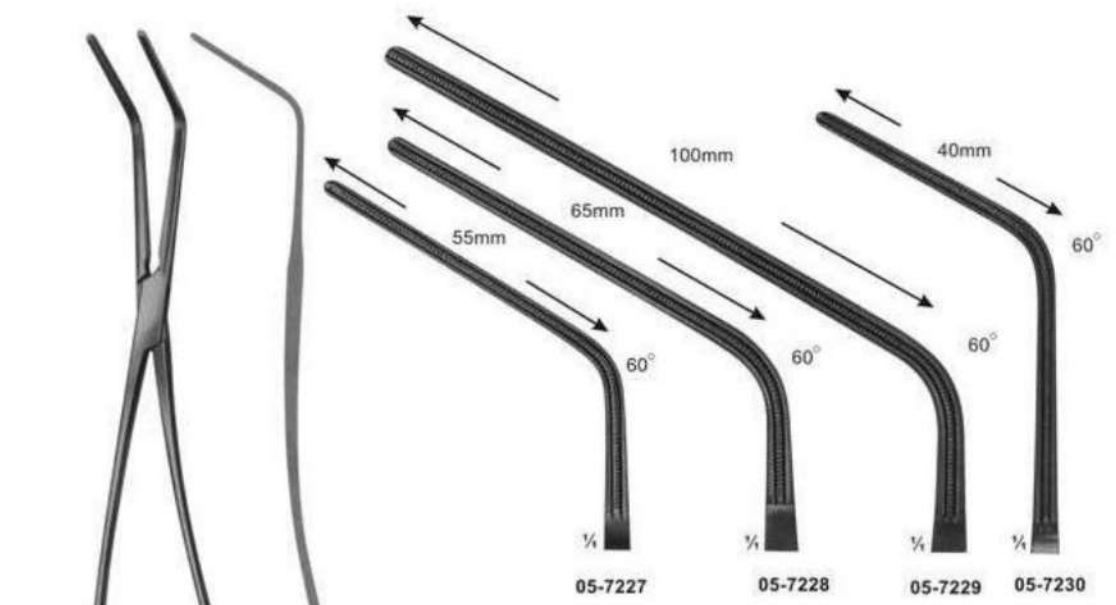

Total Length:	230 mm	280 mm	305 mm	240 mm
Length of jaws:	85 mm	100 mm	135 mm	93 mm

1/2 05-7227 - 05-7230
DE BAKEY

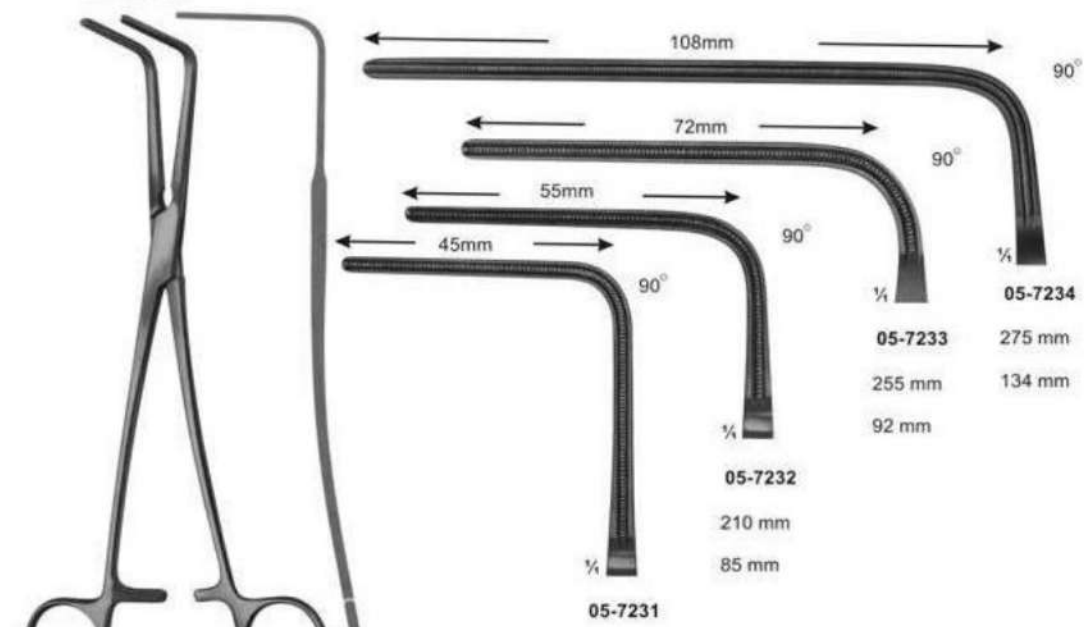

Total Length:	225 mm	275 mm	255 mm	134 mm
Length of jaws:	93 mm	85 mm	92 mm	

1/2 05-7231 - 05-7234
DE BAKEY



05-7235
50mm



05-7236
50mm



05-7237
COOLEY
100 mm

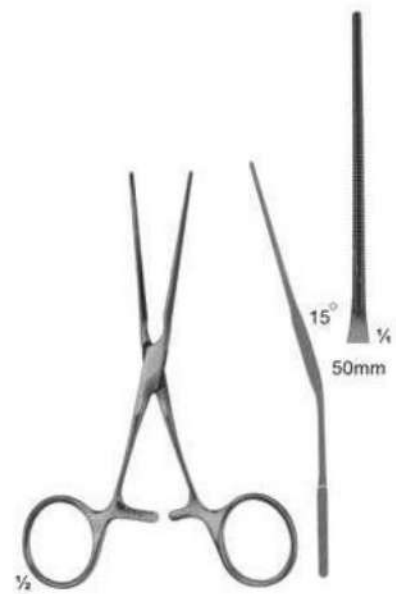

05-7238
COOLEY
125 mm

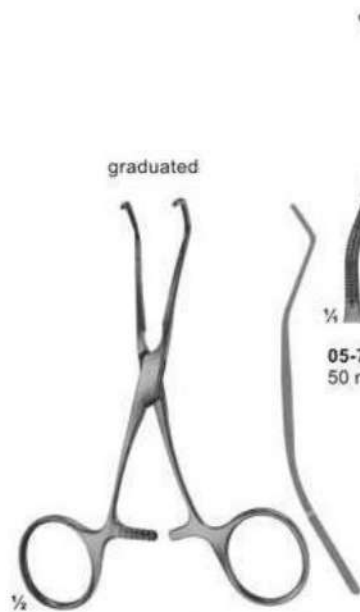

05-7239 - 05-7240
COOLEY
120 mm, 115 mm

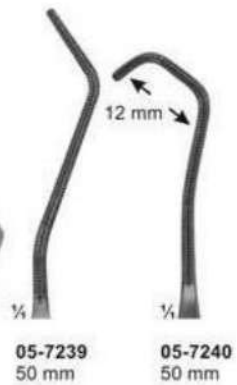

05-7240
50 mm

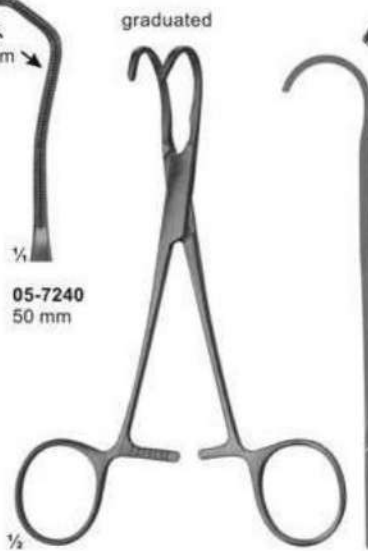

05-7241 - 05-7242
COOLEY-BECK
150 mm, 155 mm

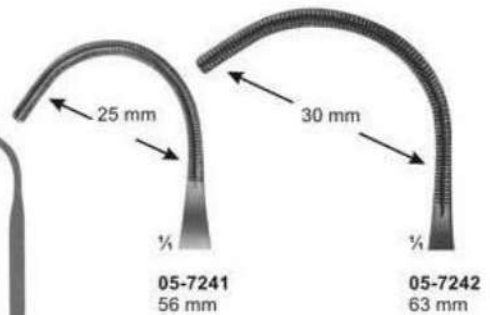

05-7242
63 mm

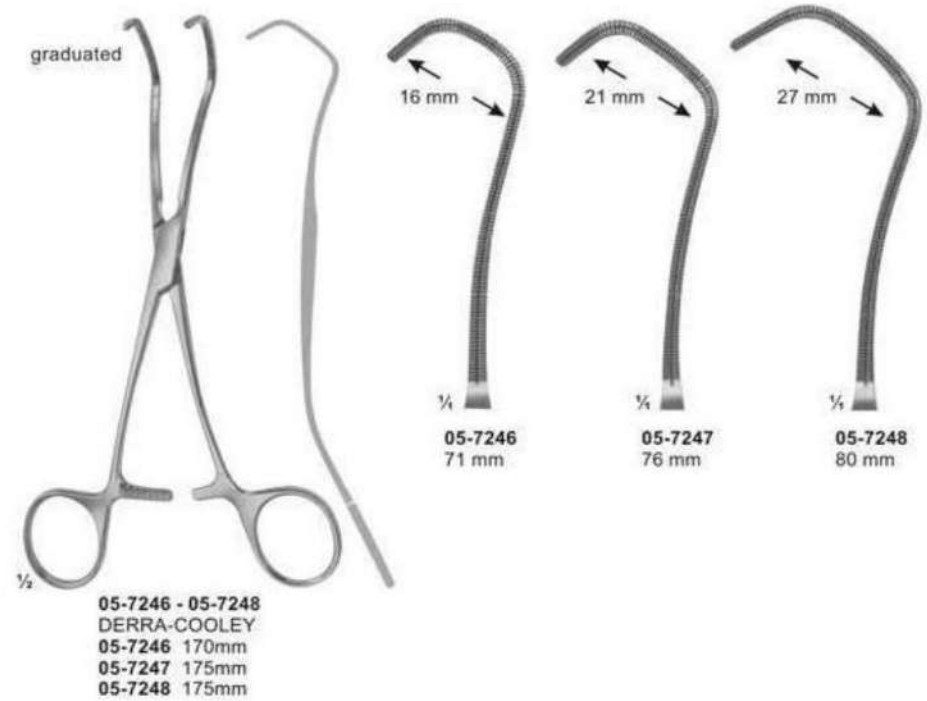
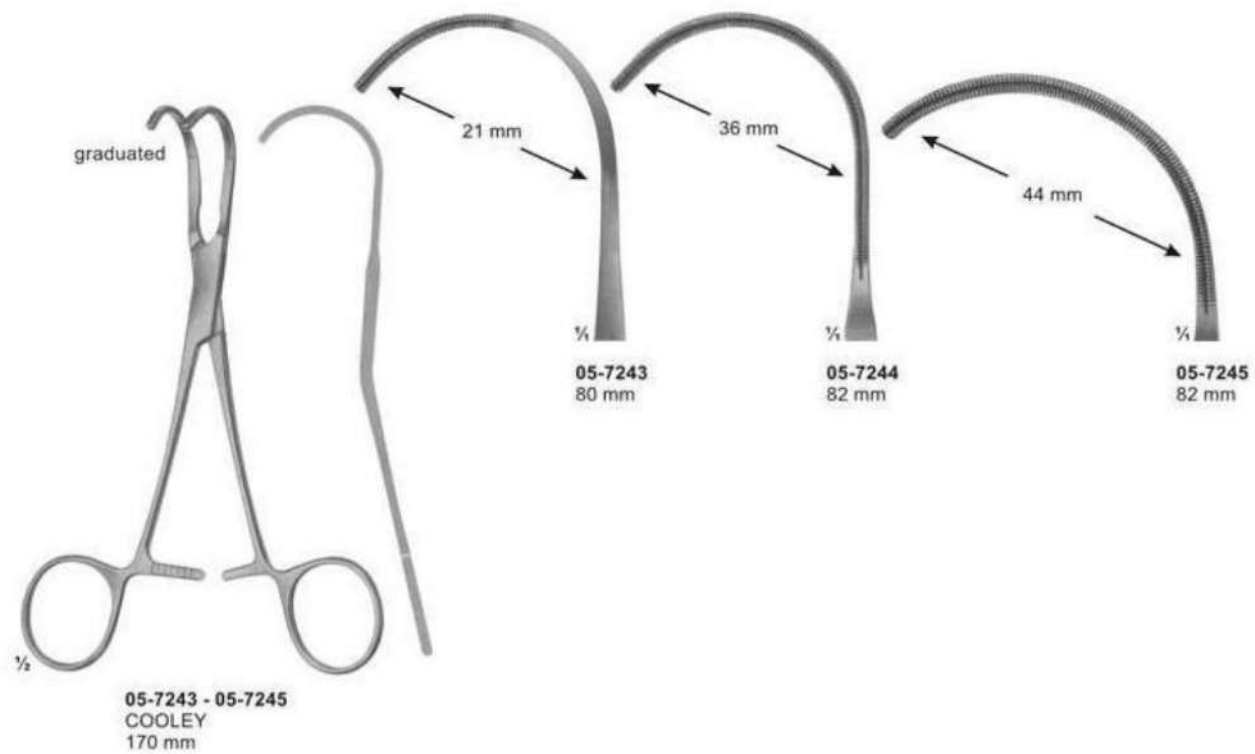

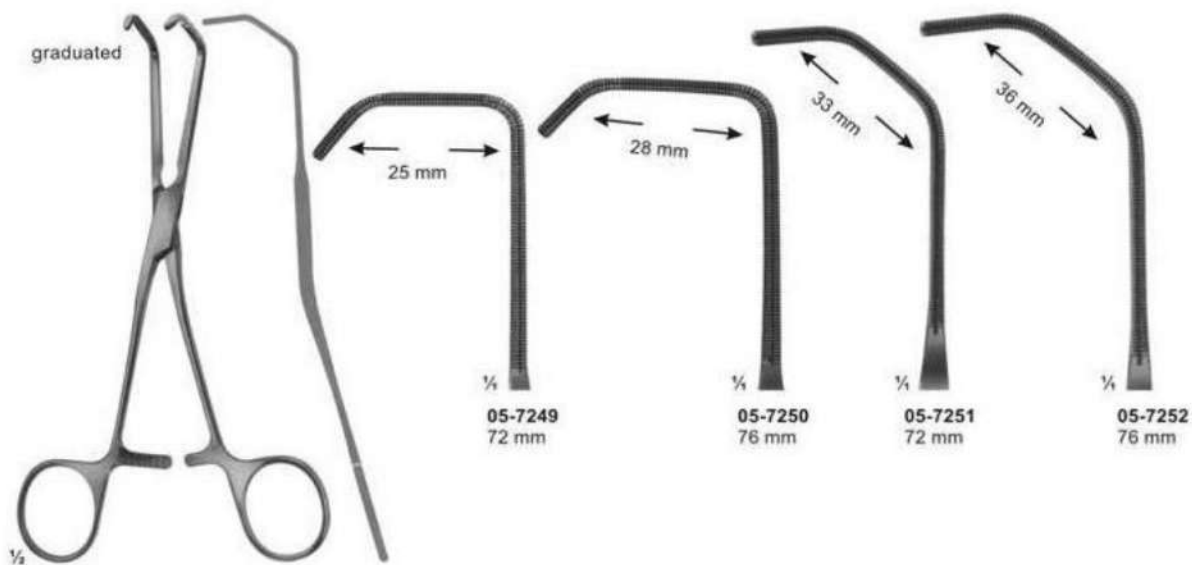

05-7249 - 05-7252
COOLEY
05-7249 165mm
05-7250 165mm
05-7251 175mm
05-7252 180mm

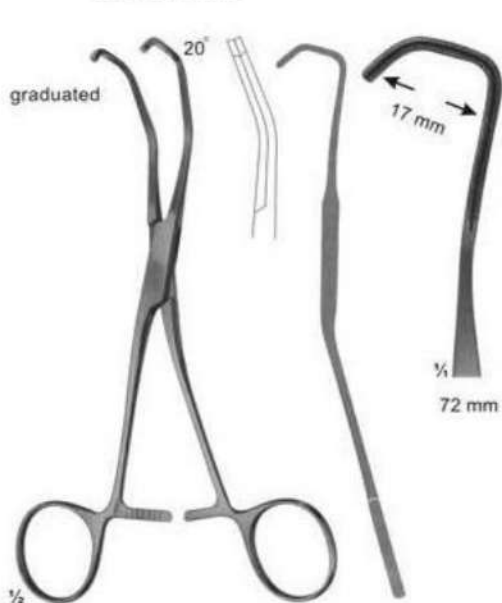

05-7253
COOLEY
170 mm

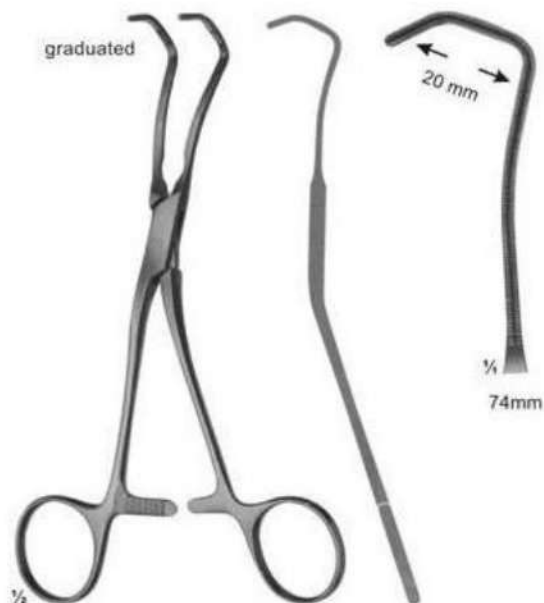

05-7254
COOLEY
175 mm

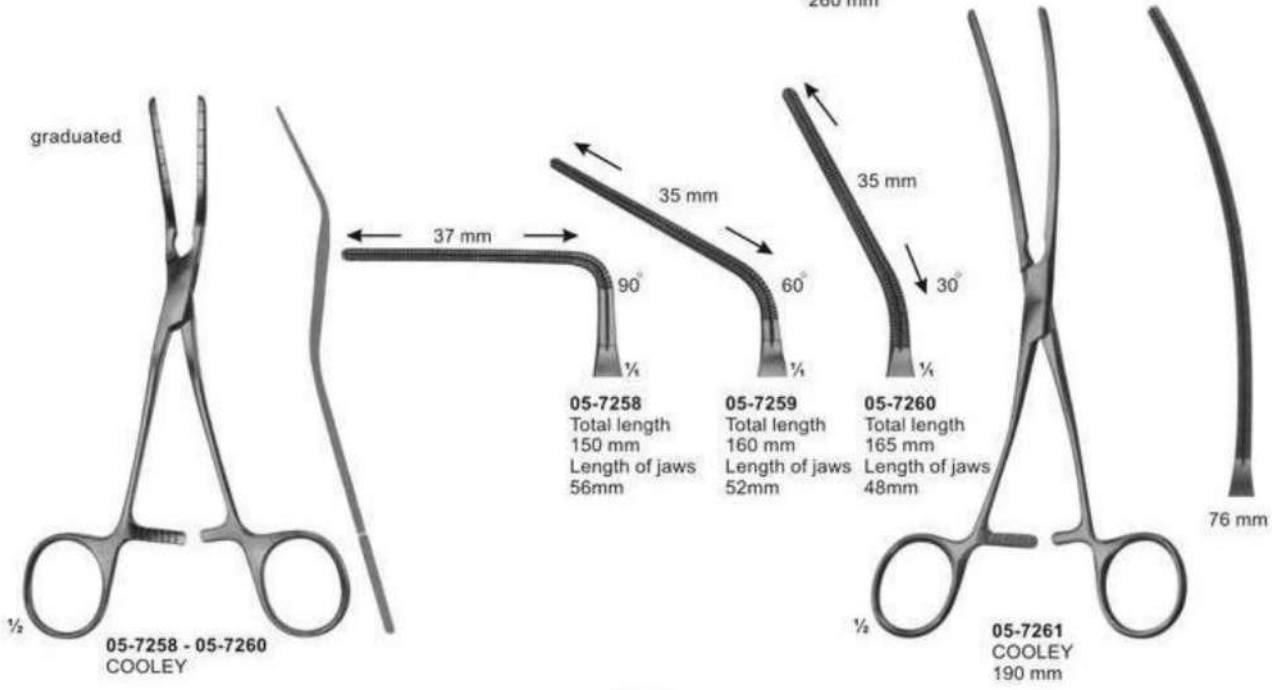
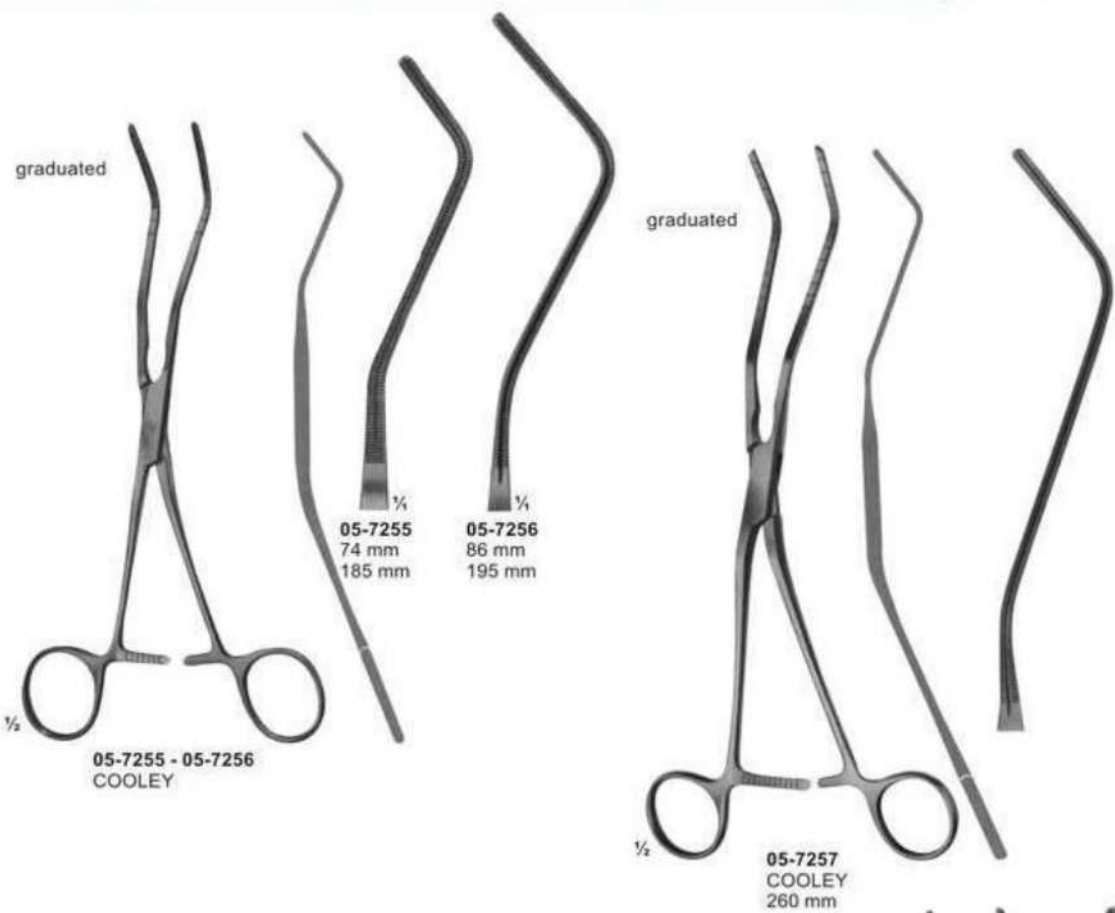

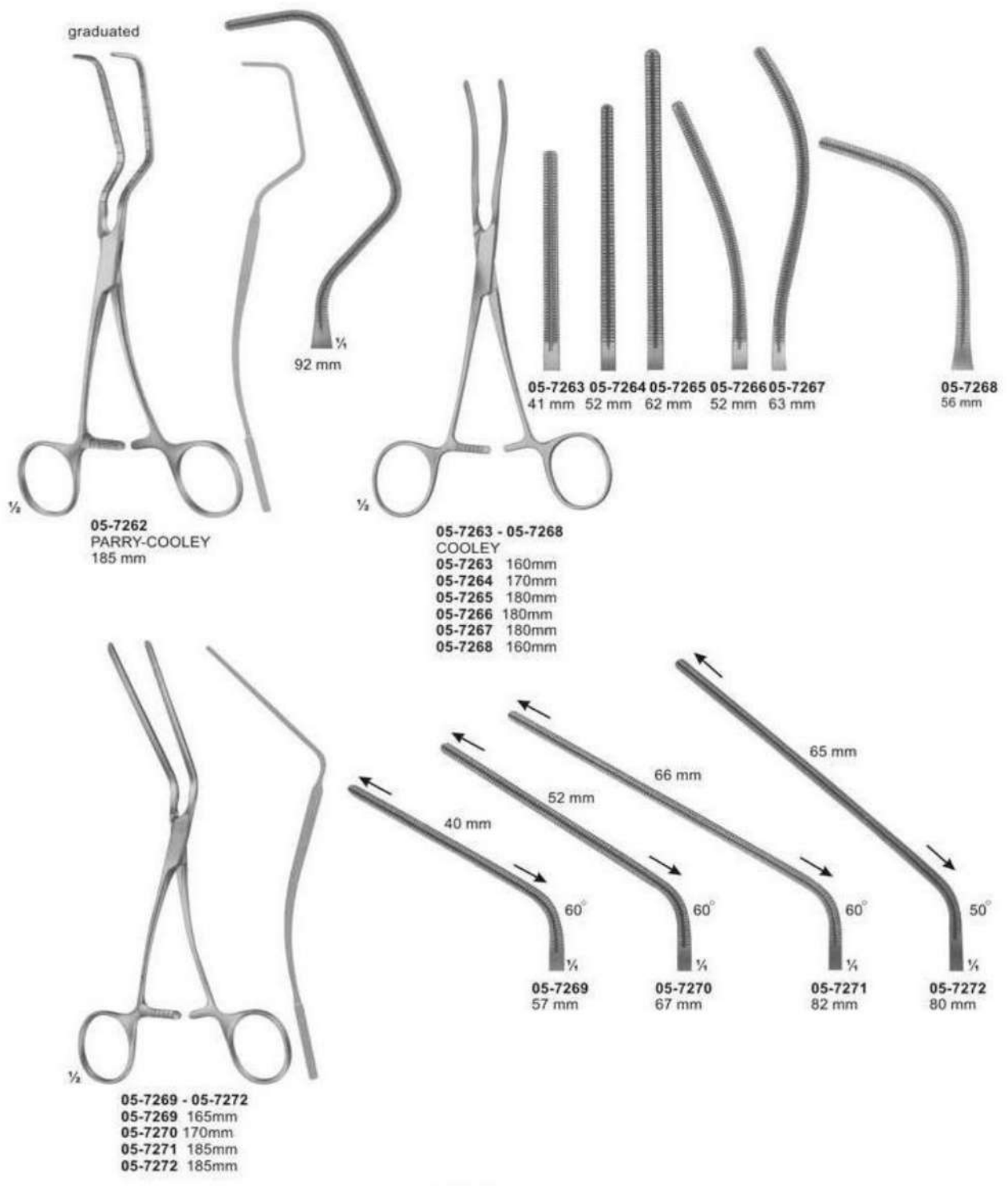



05-7273 - 05-7282
 DARDIK
 05-7273 150 mm 05-7278 170 mm
 05-7274 150 mm 05-7279 170 mm
 05-7275 150 mm 05-7280 170 mm
 05-7276 145 mm 05-7281 160 mm
 05-7277 130 mm 05-7282 135 mm

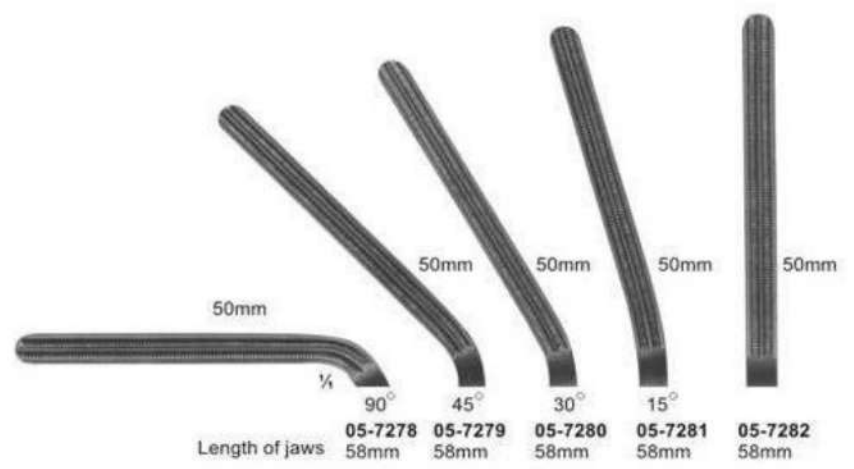
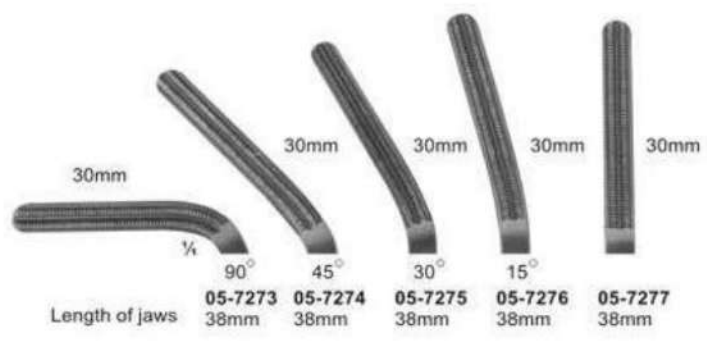

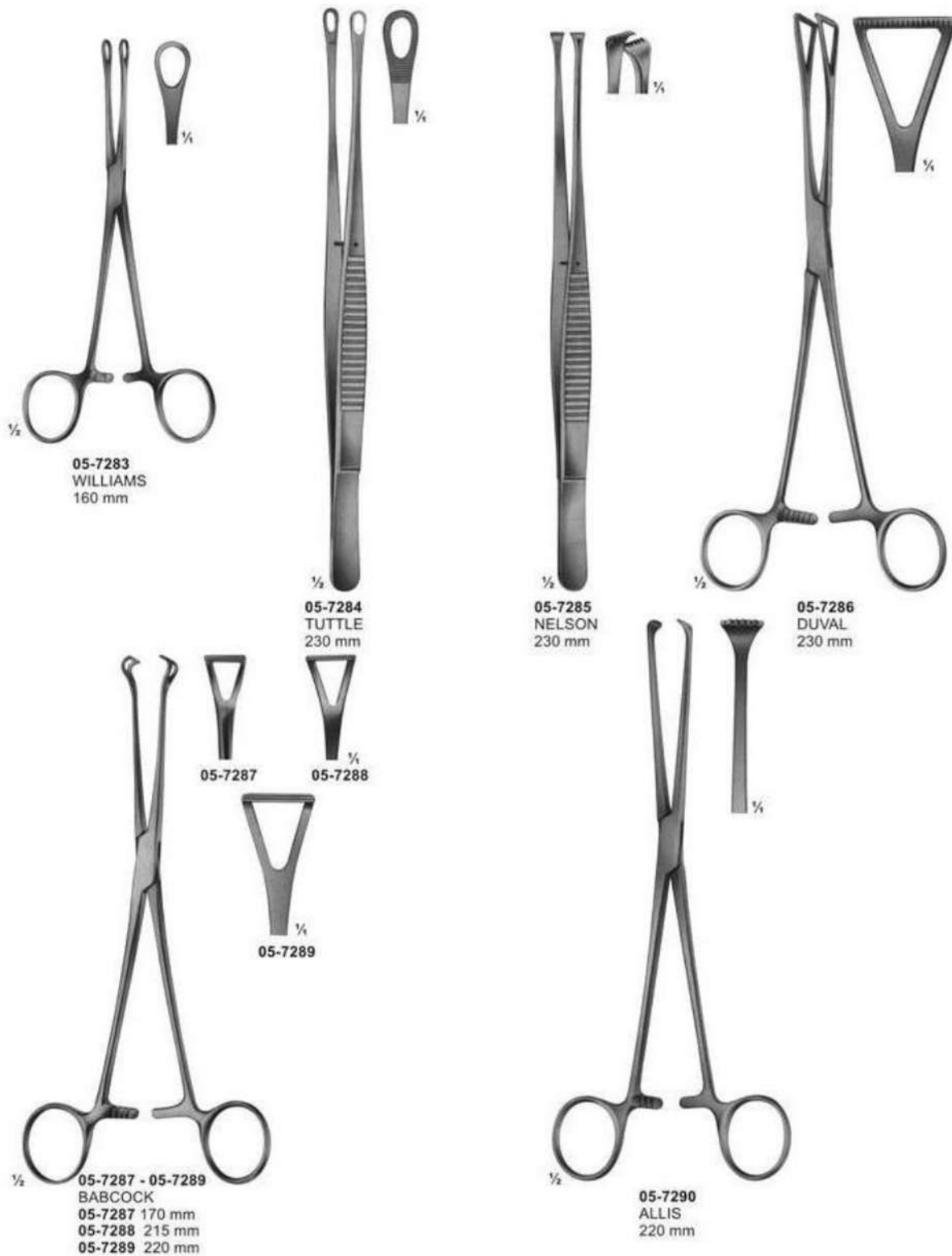

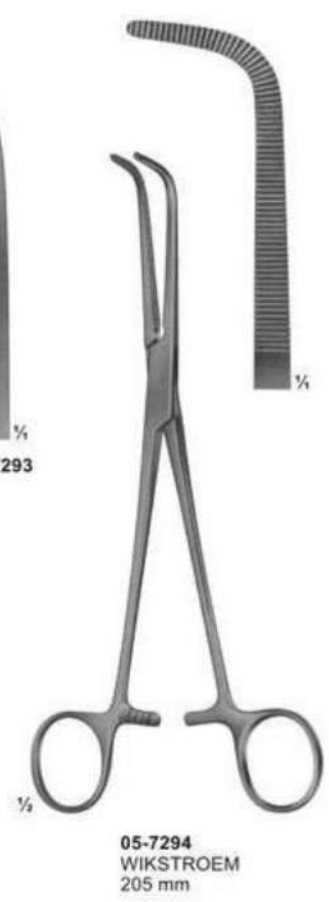



05-7295
MIXTER
230 mm



05-7296 - 05-7297
MIXTER

05-7296
220 mm

05-7297
250 mm



05-7298
HOEPFNER
Vessel clamp
160 mm



05-7299
SATINSKY
Anastomosis clamps
265 mm

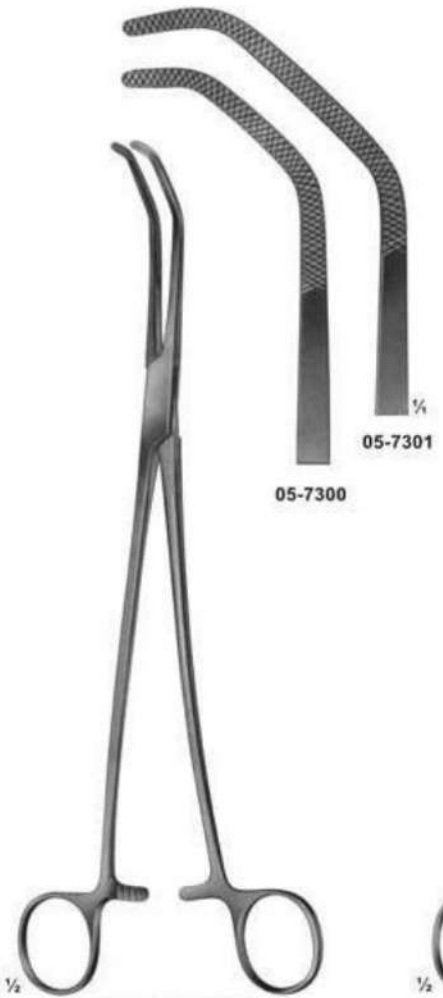

05-7300 - 05-7301
SATINSKY
Anastomosis clamps
265 mm



05-7302
HARKEN
240 mm



05-7303
PERTUISET
Carotid Clamp
90 mm

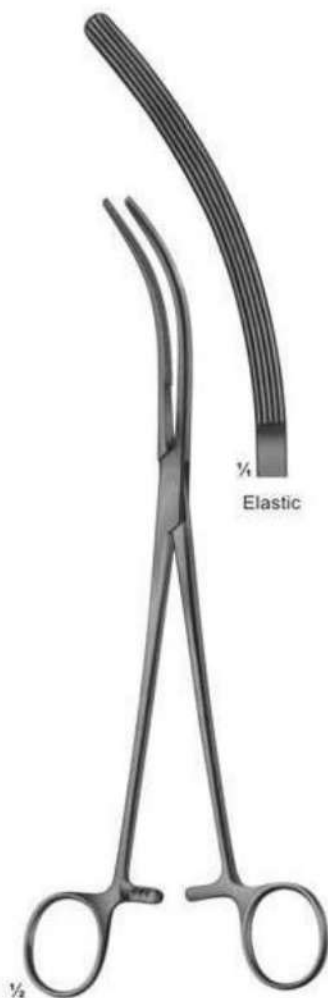

05-7304
CRAFOORD-SELLORS
240 mm

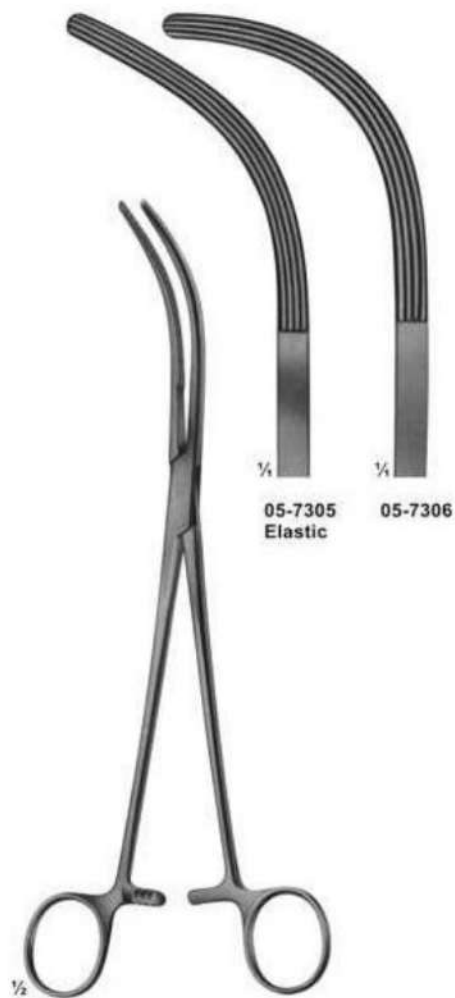

05-7305 - 05-7306
CRAFOORD
240 mm



05-7307
PRICE THOMAS
225 mm



05-7308
jaws with pins

05-7309
jaws with pins

05-7308 - 05-7309
PRICE THOMAS
225 mm



05-7310
SCHUMACHER
Sternum shears
210 mm



05-7311
LEBSCHÉ
Sternum chisel
200 mm



05-7312
230 mm



05-7313
COLLIN
195 mm



05-7314
GLUCK
190 mm



05-7315
BETHUNE
340 mm



05-7316
BRUNNER
Universal Pattern
340 mm



05-7317
GIERTZ-STILLE
250 mm

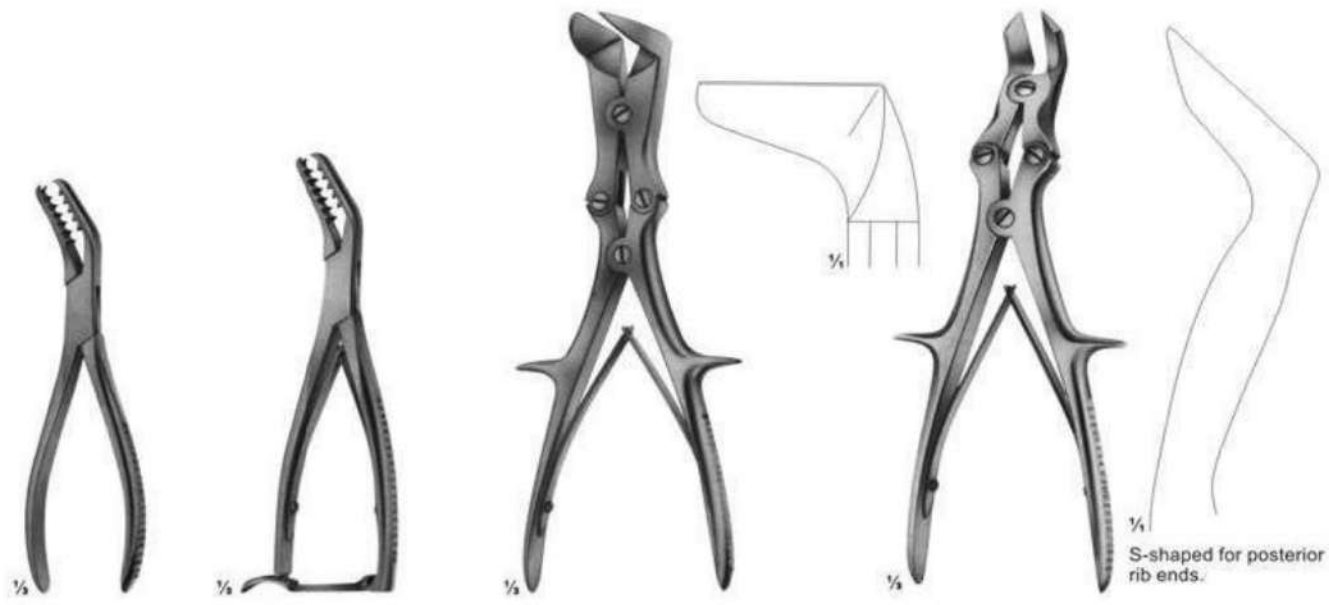

05-7318
SEMB
Rib-and Bone
Holding forceps
190 mm

05-7319
SEMB
Rib-and Bone
Holding forceps
190 mm

05-7320
LISTON-STILLE
265 mm

05-7321
LISTON-KEY-HORSLEY
(Tudor Edwards)
255 mm

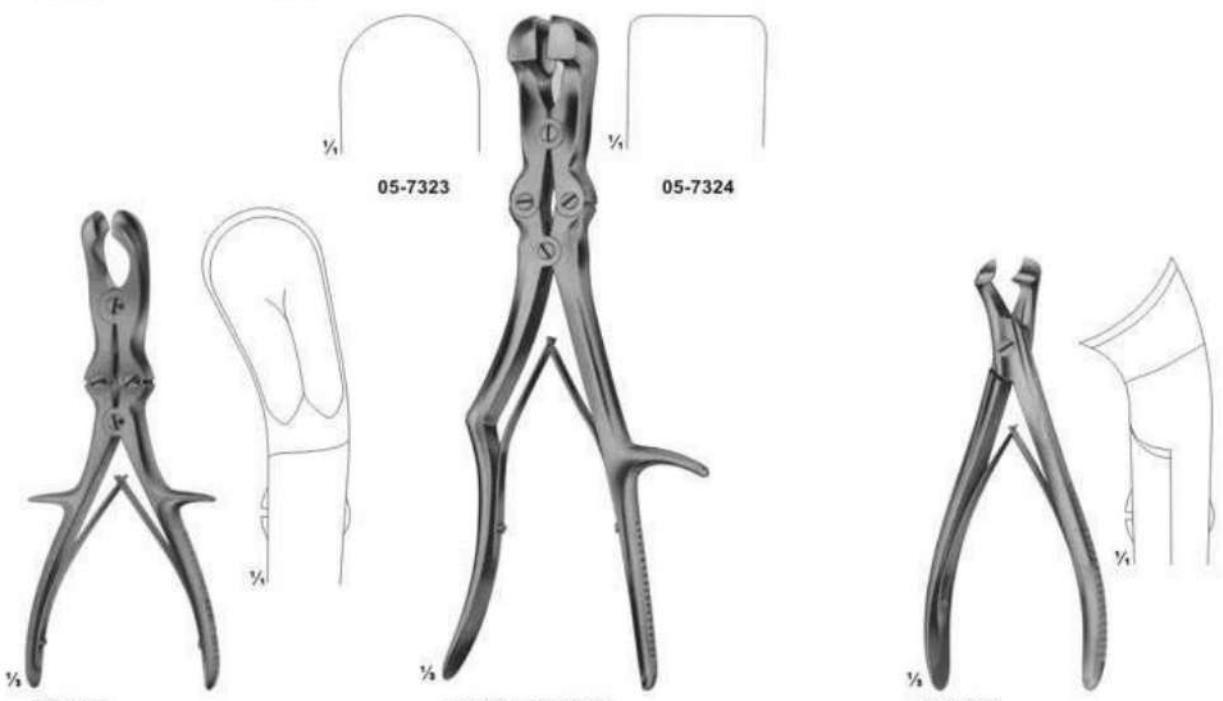

05-7322
SEMB
Rib Rongeur to shorten
the rib stumps
240 mm

05-7323 - 05-7324
SAUERBRUCH-CORYLLOS
Rib rongeurs to shorten
the rib stumps
310 mm

05-7325
MARKWALDER
Rib Rongeur to Round
the rib stumps
190 mm



05-7326 - 05-7327
DOYEN
for children
175 mm



05-7328 - 05-7329
DOYEN
for adults
175 mm



05-7330 - 05-7331
DOYEN
240 mm

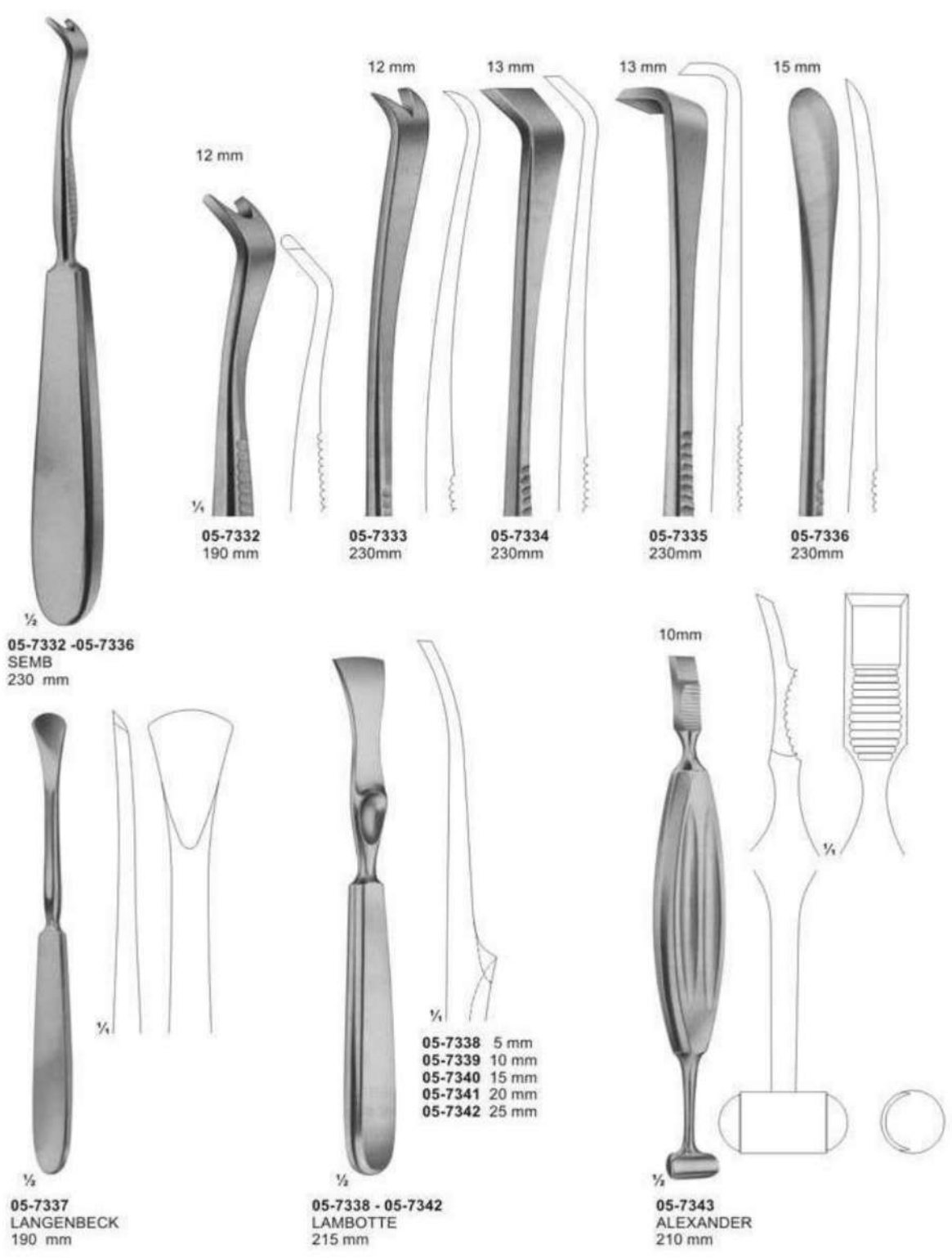



05-7344
FINOCHIETTO
Blades
18X21 mm



05-7345
HERTZLER
Blades
20X25 mm



05-7346
TUFFIER
Blades
43X53 mm

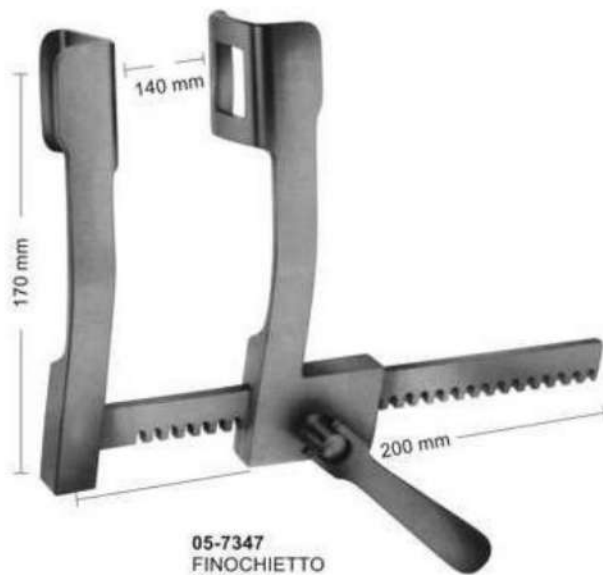

05-7347
FINOCHIETTO
Blades
36X45 mm

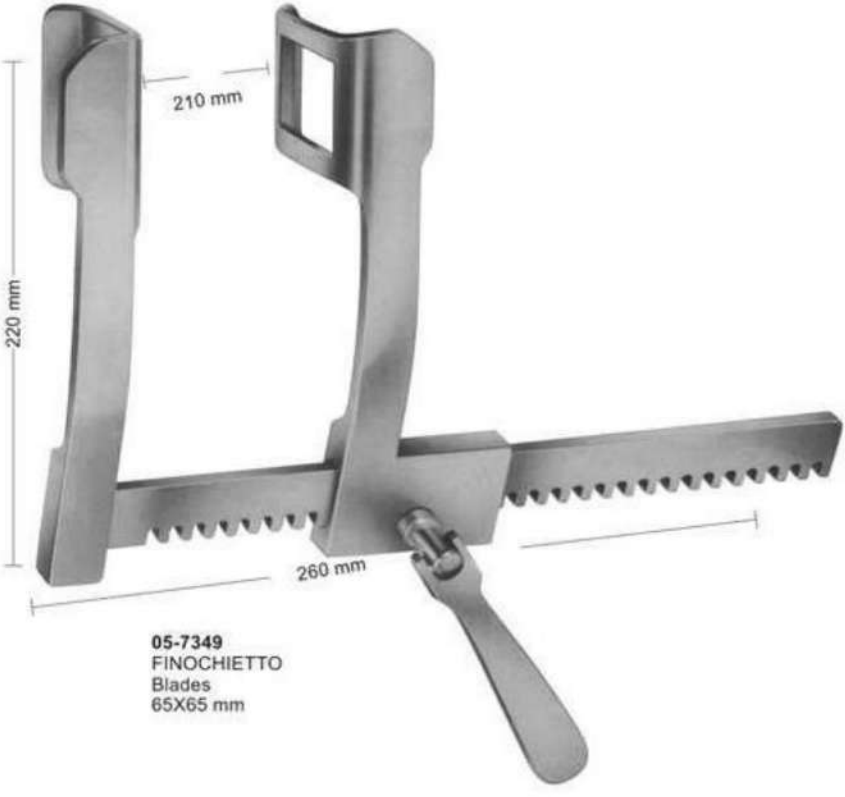
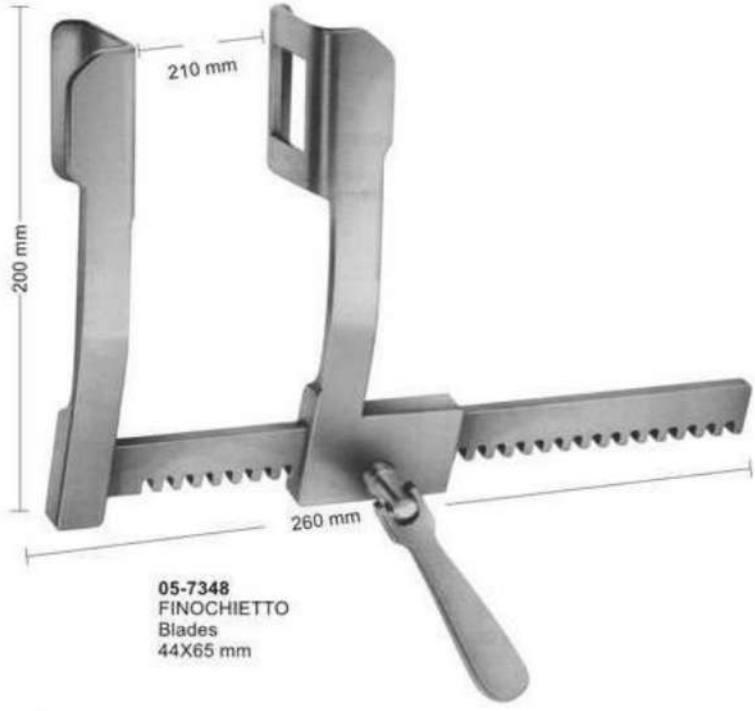

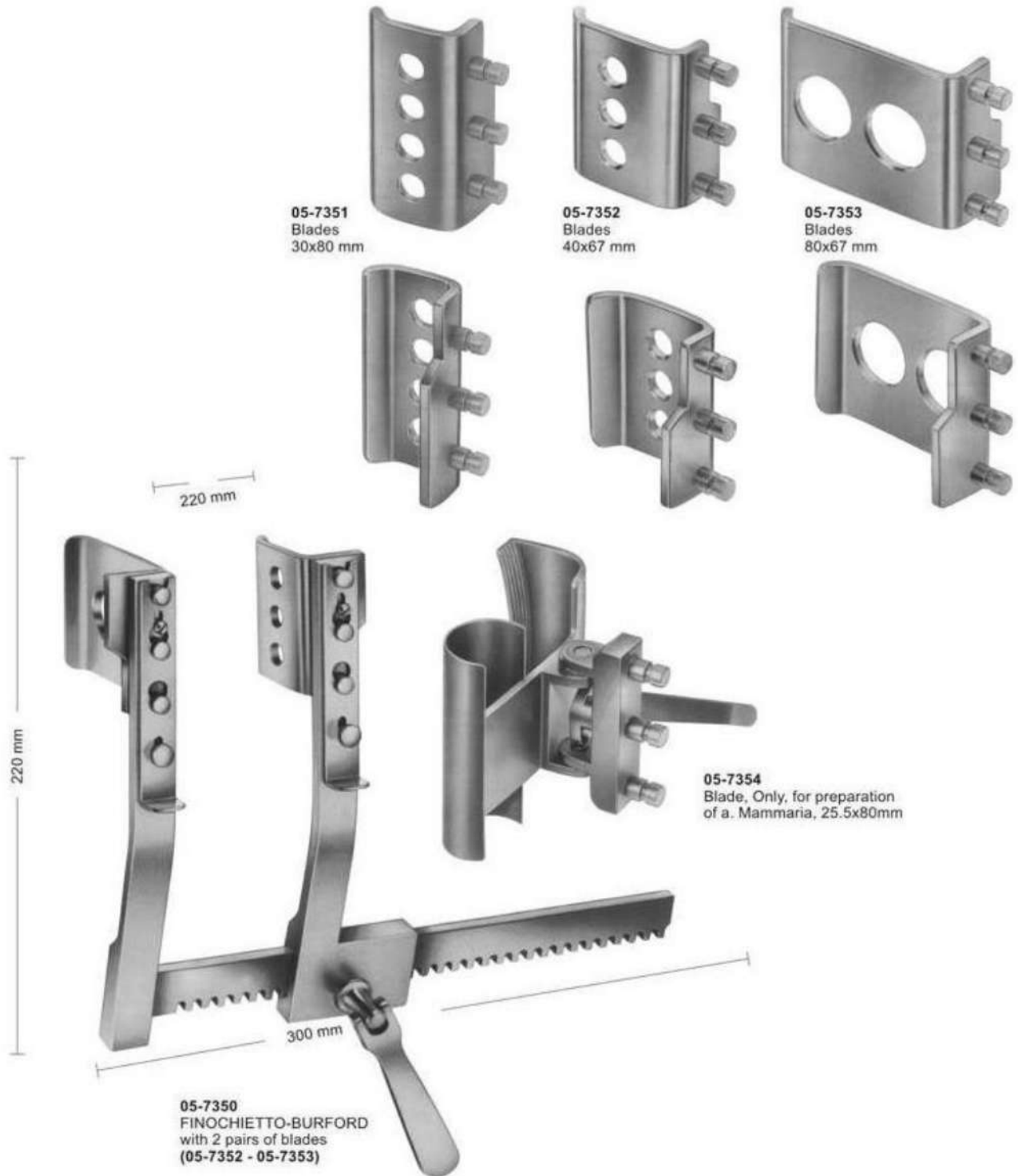

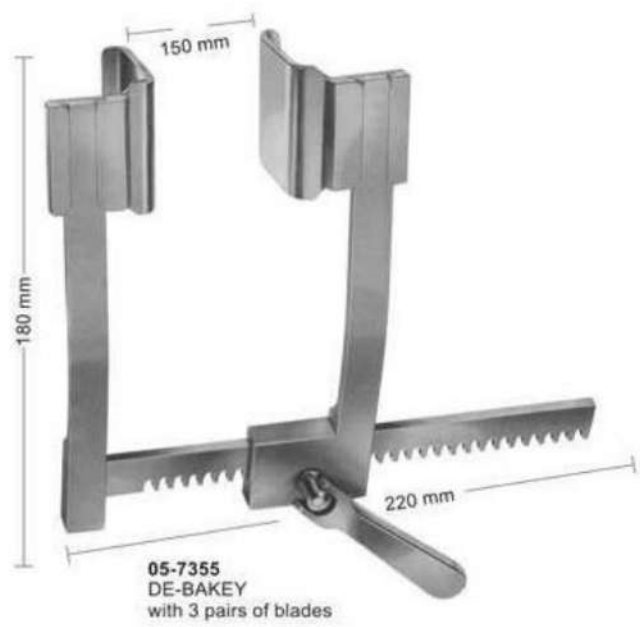

Components for **05-7355**
Spreader only Blades only
05-7357 30x30mm
05-7358 40x40mm
05-7359 50x50mm
The Blades are delivered in Pairs.

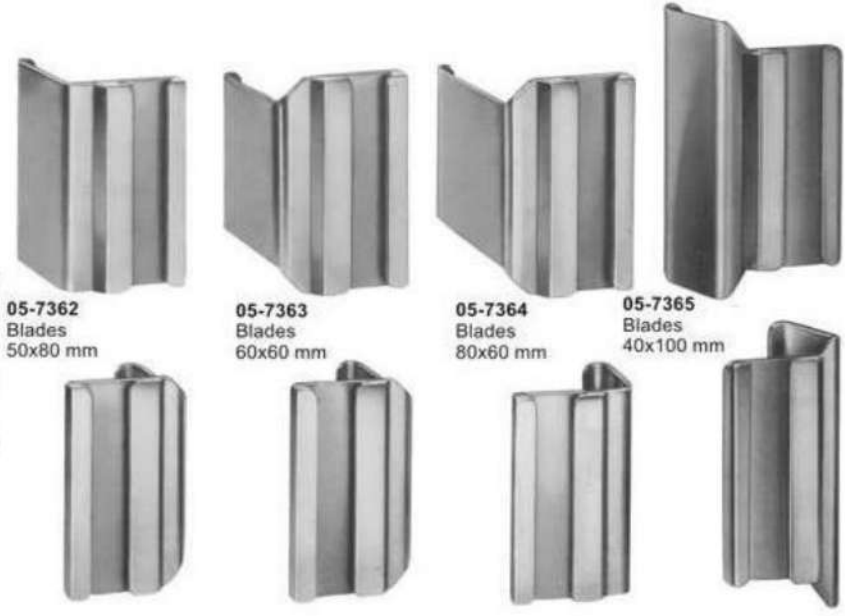
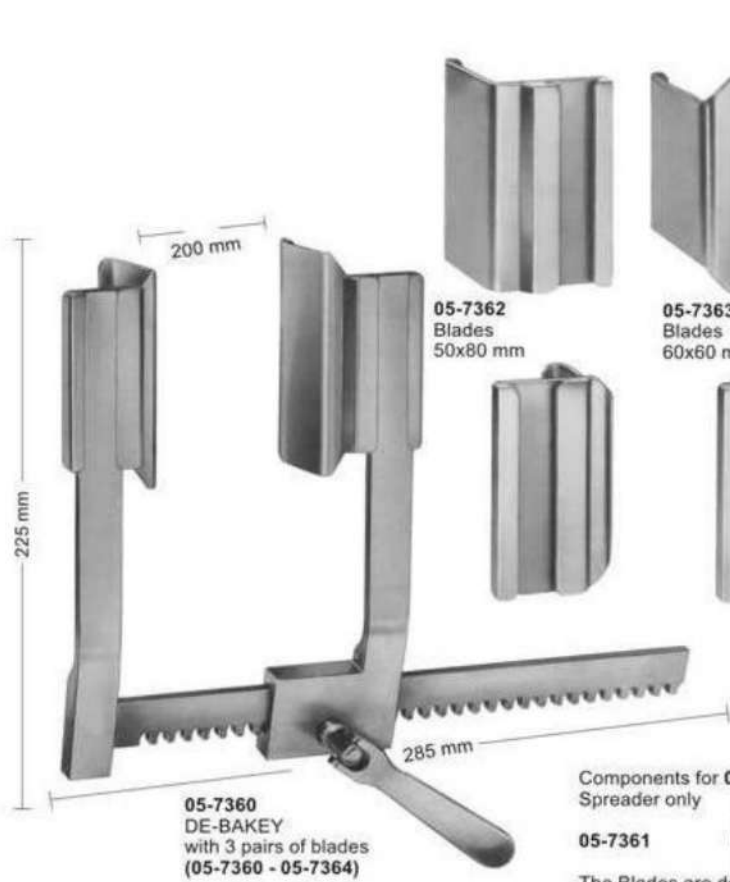

Components for **05-7360**
Spreader only Blades only
05-7362 50x80mm
05-7363 60x60mm
05-7364 40x100mm
The Blades are delivered in Pairs.



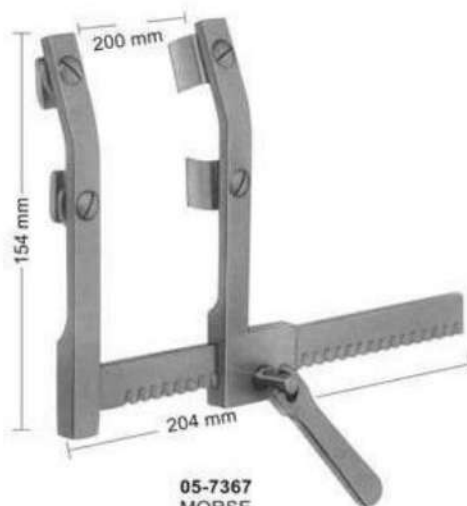

05-7367
MORSE
Sternotomy spreader
for children, with moveable
double blades each blade
12x20 mm

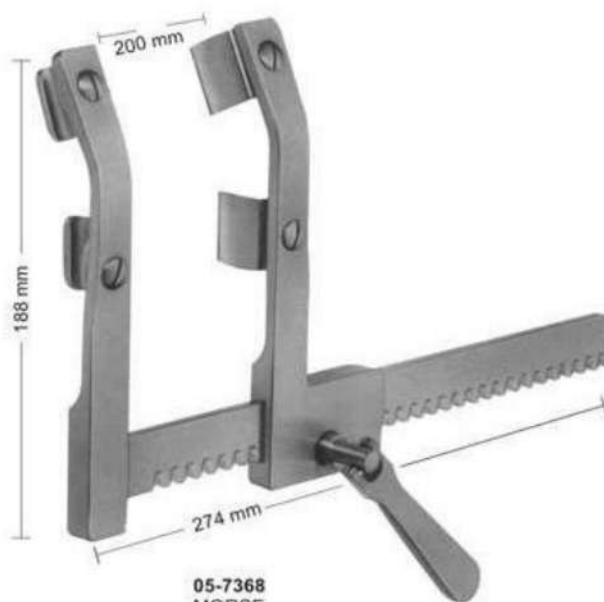

05-7368
MORSE
Sternotomy spreader
for adults, with moveable
double blades each blade
19x19 mm

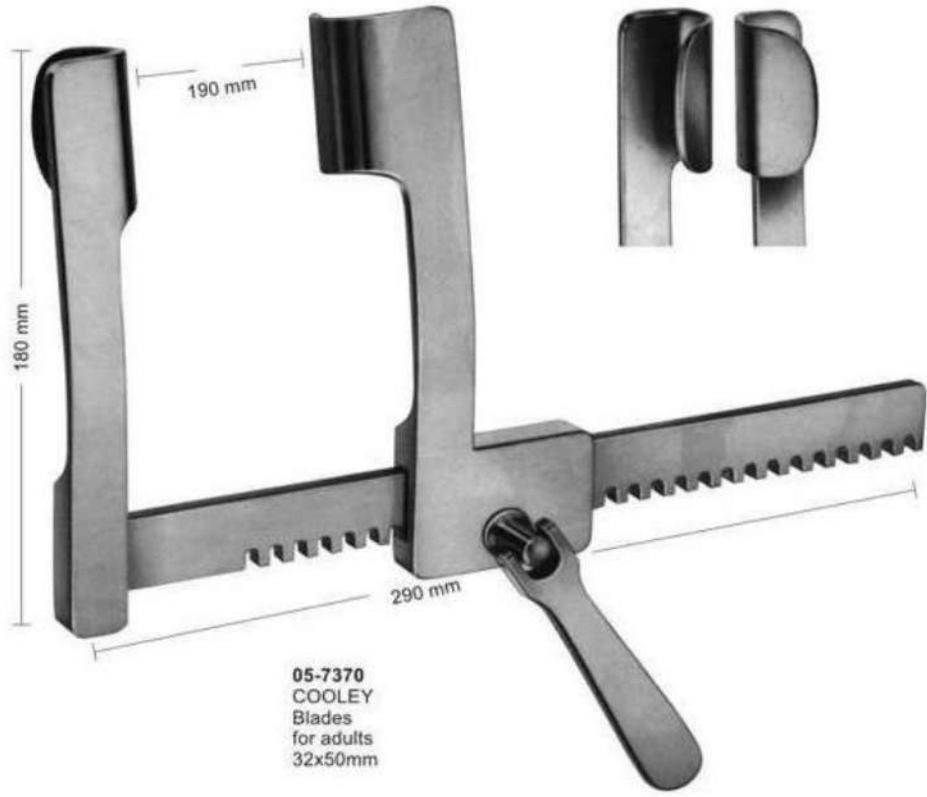
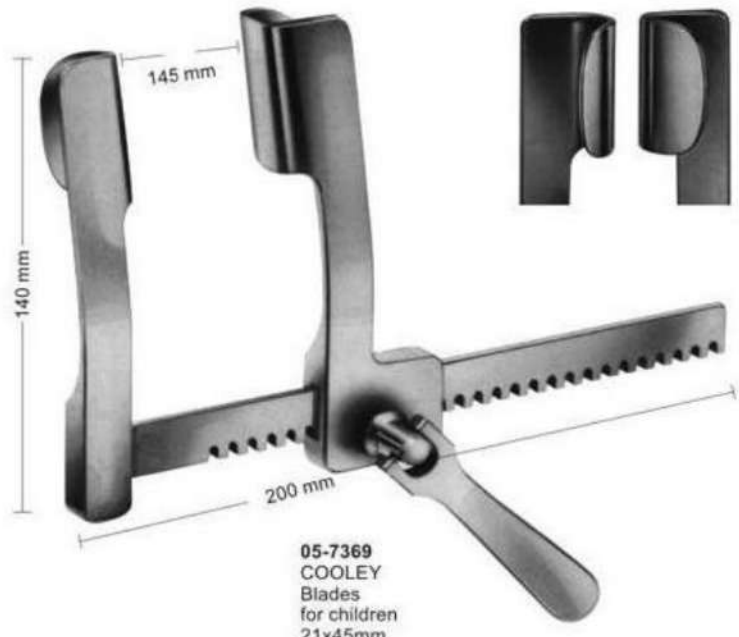



05-7371
Blades
75x75 mm



05-7373
Blades
42x65 mm

Blades with Ball Snap System
Delivery: in Pairs

05-7371 - 05-7373
Thoracic Retractor (Mercedes-Retractor)
complete consisting of:
05-7371 Retractor only
05-7372 1 Pair of blades 75x75 mm
05-7373 1 Pair of blades 42x65 mm



05-7374 SELLORS Rib spreader and contractor with swivel blades 200 mm



05-7375 BAILEY 150 mm



05-7376 - 05-7377 BAILEY 200 mm

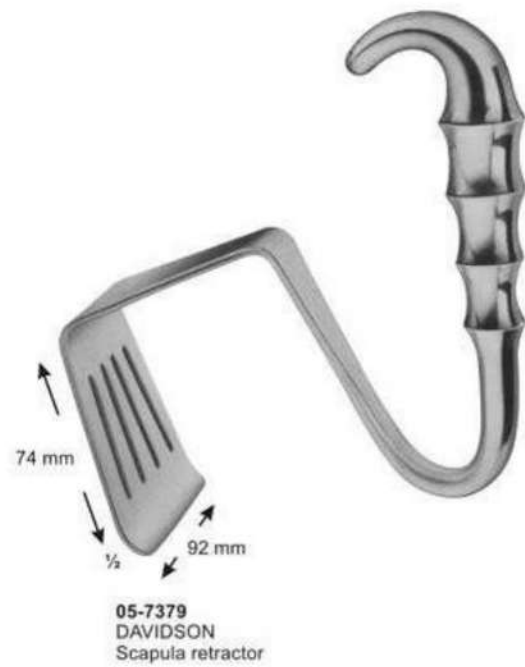
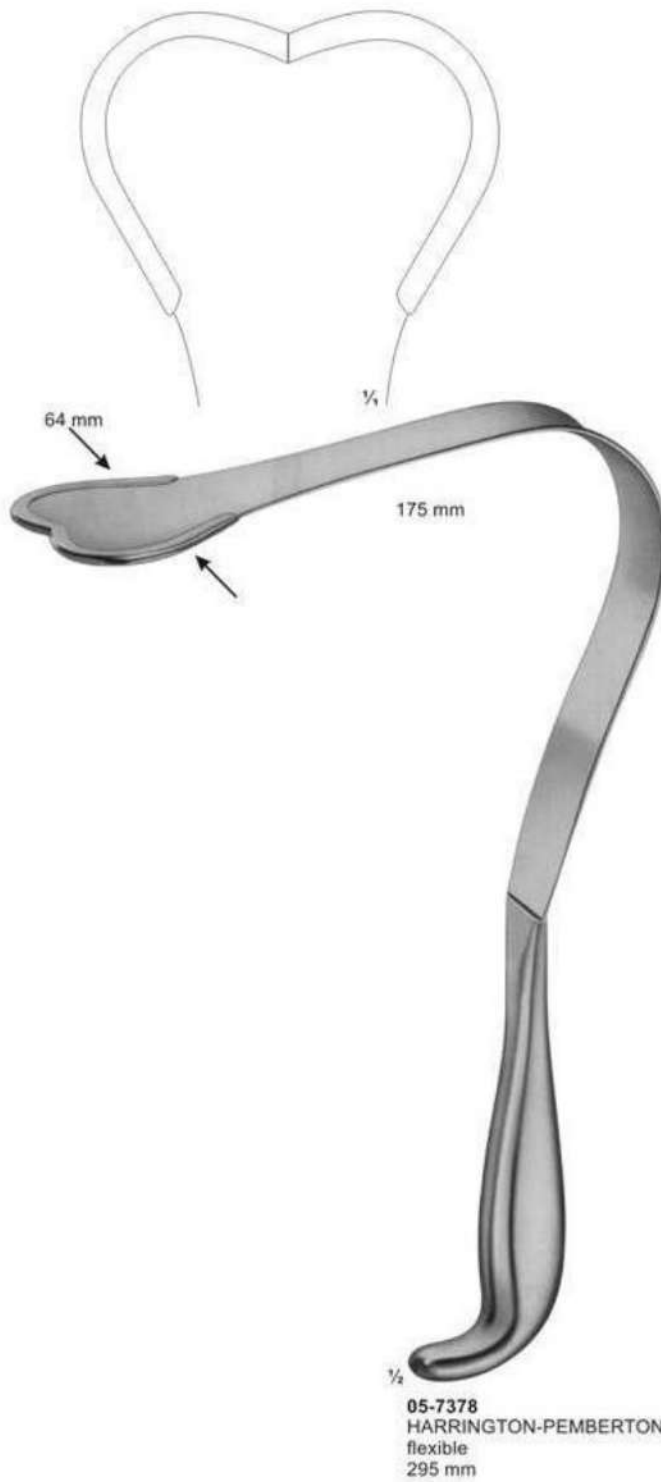

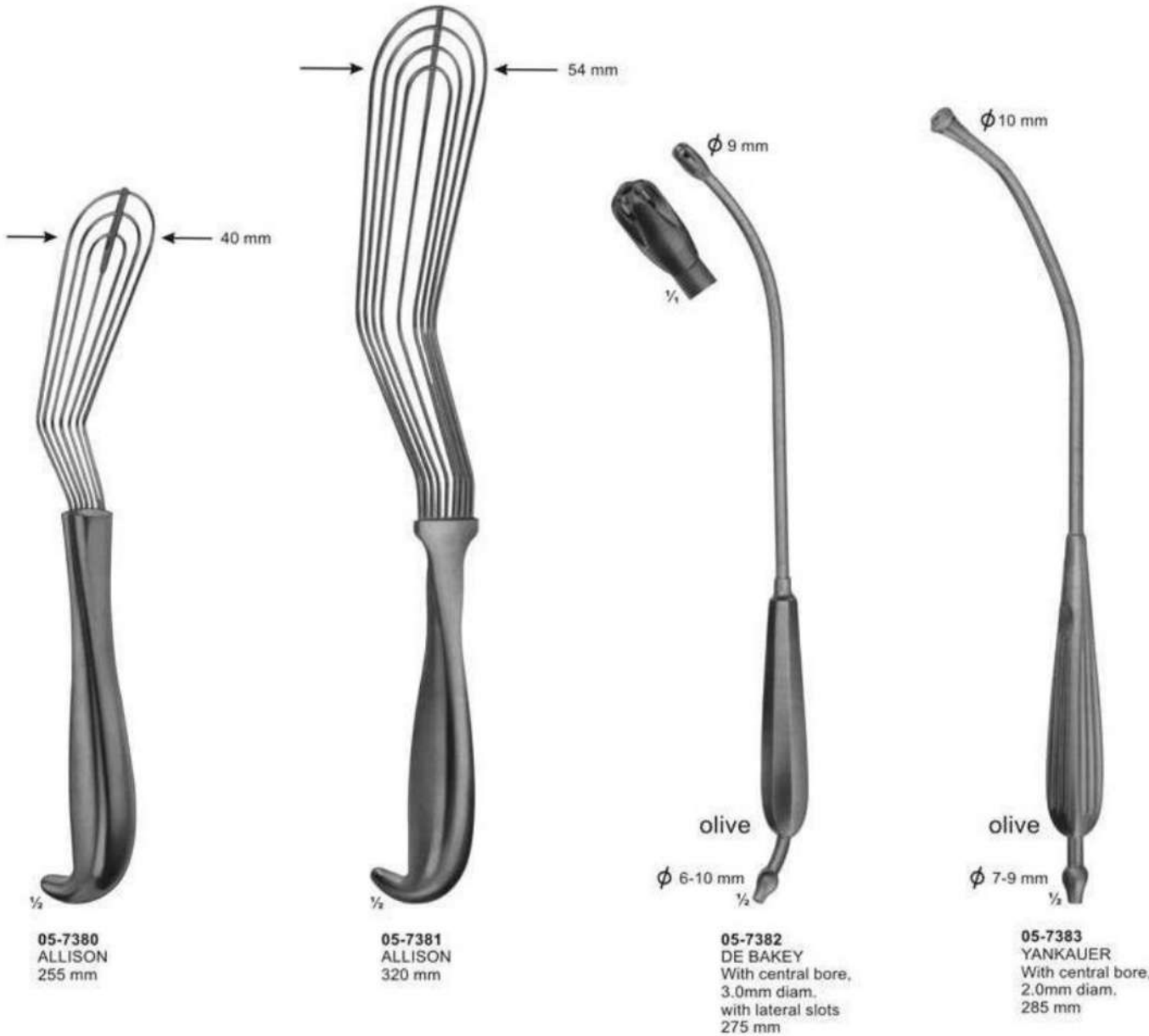

Angled positions for punchus

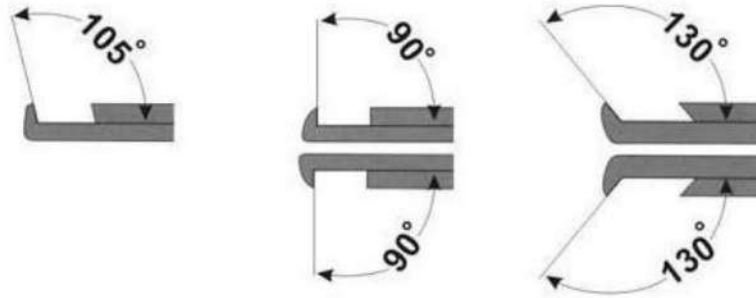

90° upwards cutting



05-7384 - 05-7385
CITELLI
05-7384 2mm
05-7385 3.5mm

90° upwards cutting

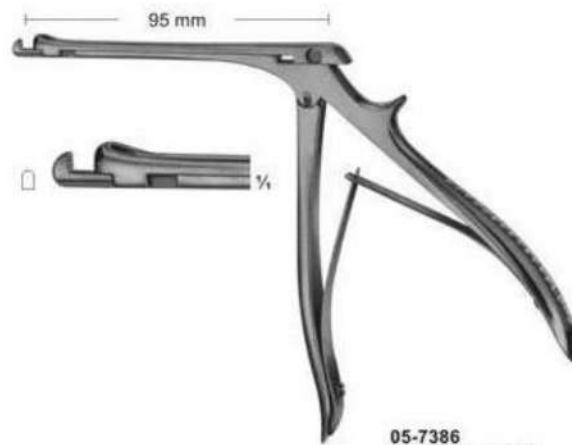

05-7386
CITELLI- BEYER
1,8 mm

90° upwards cutting



05-7387
4 mm



05-7388
5 mm



05-7387 - 05-7388
KERRISON

90° upwards cutting

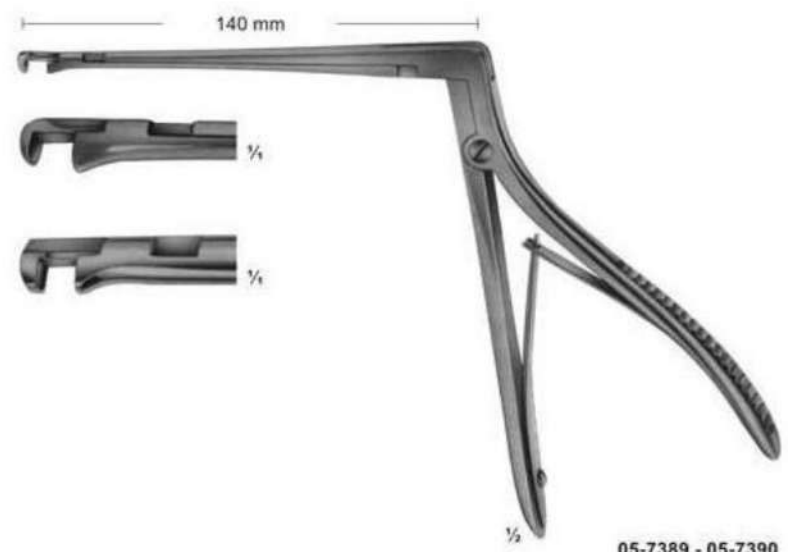

05-7389
3,3 mm



05-7390
4,0 mm



05-7389 - 05-7390
HAJEK-KOFLER

130°

upwards cutting

KERRISON-JACOBY

05-7391
1 mm



FERRIS-SMITH-KERRISON

05-7392
2 mm



05-7393
3 mm



05-7394
4 mm



05-7395
5 mm

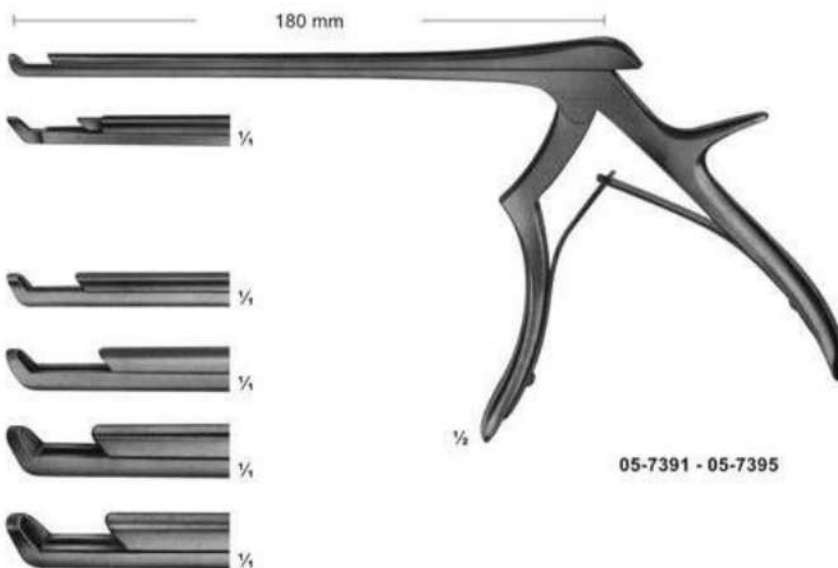

90°

upwards cutting

KERRISON-JACOBY

05-7396
1 mm



05-7397
2 mm



FERRIS-SMITH-KERRISON

05-7398
3 mm



05-7399
4 mm



05-7400
5 mm

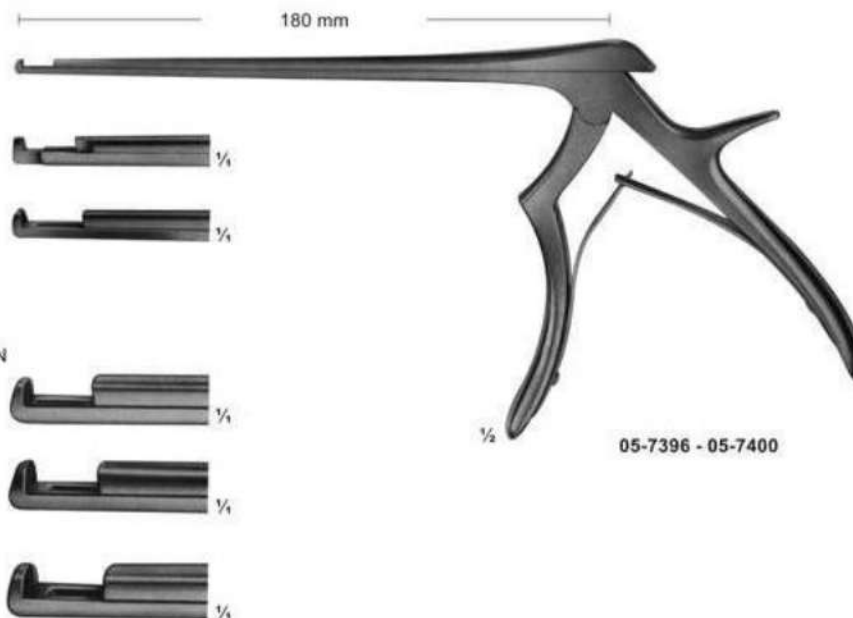

Angled positions for rongeurs

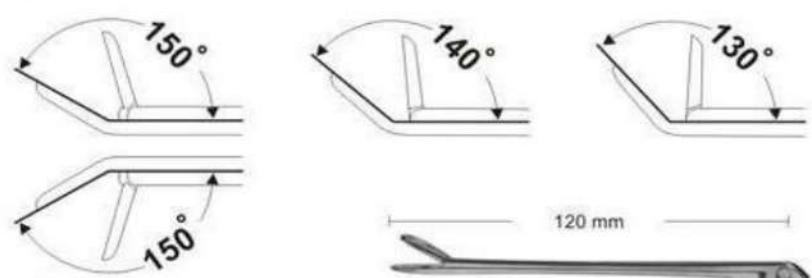

- 05-7401
3,0 mm
- 05-7402
3,6 mm
- 05-7403
4,2 mm
- 05-7404
4,8 mm
- 05-7405
5,8 mm

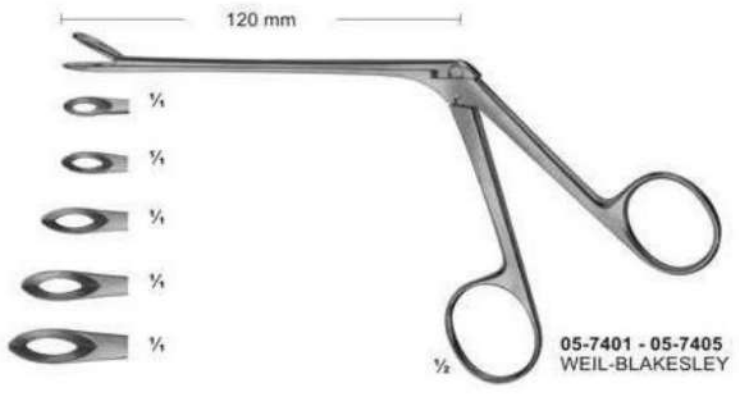

130°

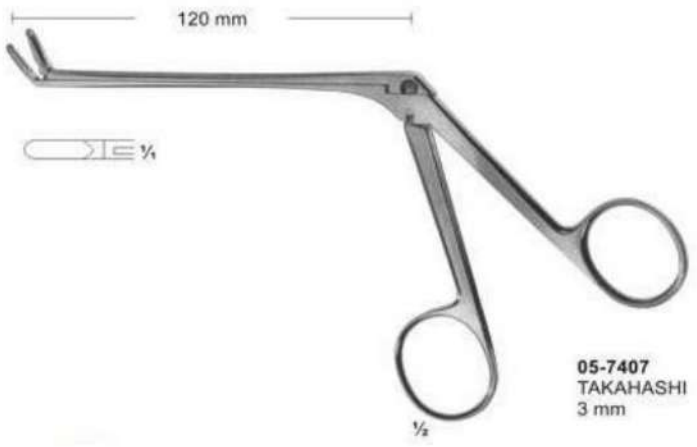

LOVE-GRUENWALD

05-7408
2 X 10 mm

05-7409
3 X 10 mm

SPURLING

05-7410
4 X 10 mm

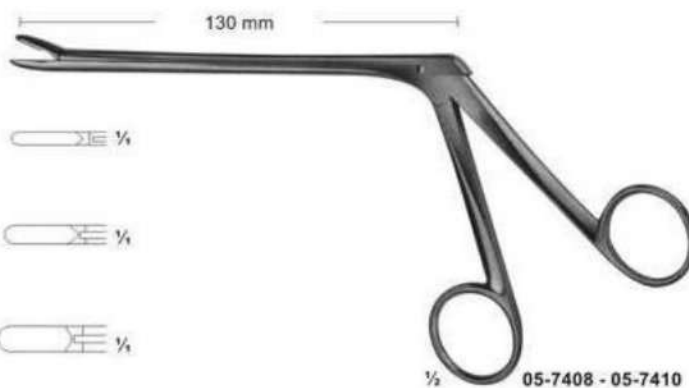

05-7411
2 mm

05-7412
3 mm

05-7413
4 mm

05-7414
5 mm

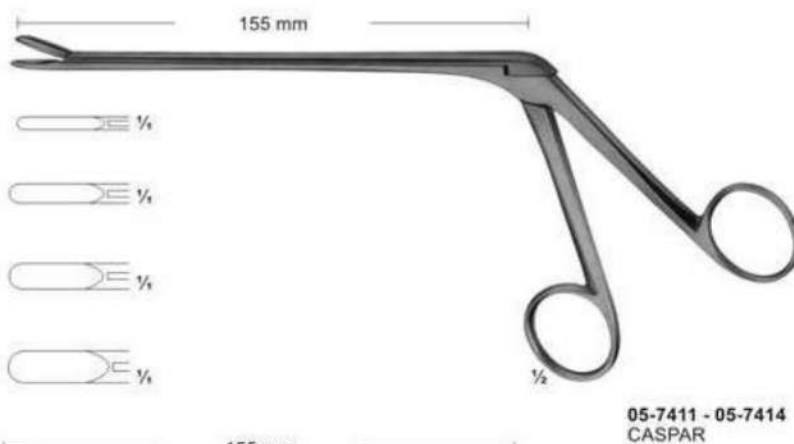

150°

05-7415
2 mm

05-7416
3 mm

05-7417
4 mm

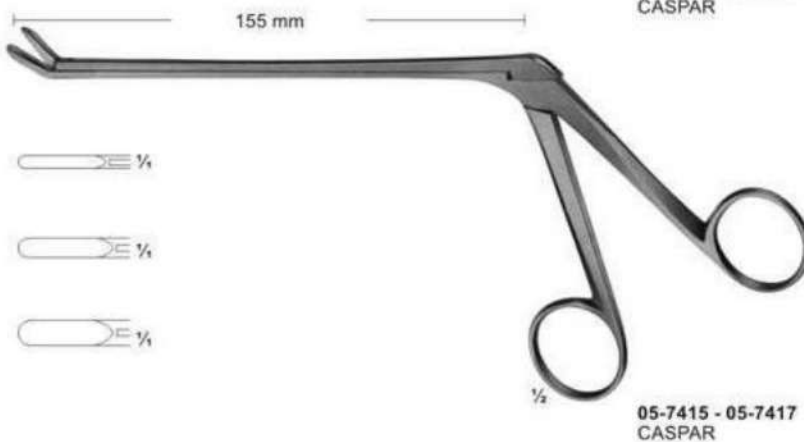

150°

Lower part of jaws movable

05-7418
2 mm

05-7419
3 mm

05-7420
4 mm



05-7418 - 05-7420
CASPAR

Length of shaft 140 mm	Length of shaft 160 mm	Length of shaft 185 mm	size of jaws
05-7421	05-7426	05-7431	2 X12 mm
05-7422	05-7427	05-7432	3 X12 mm
05-7423	05-7428	05-7433	4 X14 mm
05-7424	05-7429	05-7434	5 X14 mm
05-7425	05-7430	05-7435	6 X16 mm

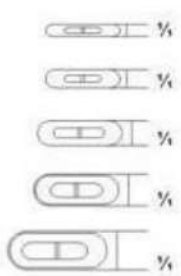

05-7421 - 05-7435
CASPAR

150°

Length of shaft 140 mm	Length of shaft 160 mm	Length of shaft 185 mm	size of jaws
05-7436	05-7439	05-7442	3 X12 mm
05-7437	05-7440	05-7443	4 X14 mm
05-7438	05-7441	05-7444	5 X14 mm



05-7436 - 05-7444
CASPAR

150°

Lower part of jaw movable

Length of shaft 140 mm	Length of shaft 160 mm	Length of shaft 185 mm	size of jaws
05-7445	05-7447	05-7449	3 X 12 mm
05-7446	05-7448	05-7450	4 X 14 mm

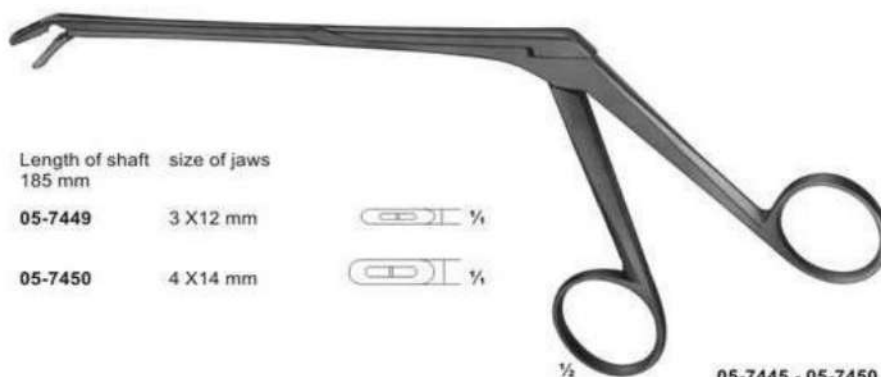

05-7445 - 05-7450
CASPAR

05-7451
2 X 10 mm
CUSHING

05-7452
3 X 10 mm
LOVE-GRUENWALD

05-7453
4 X 10 mm
SPURLING

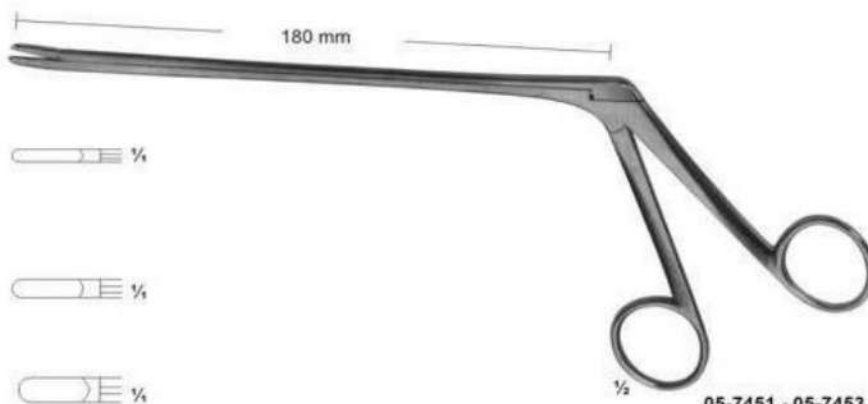

05-7451 - 05-7453

150°

05-7454
3 X 10 mm
LOVE-GRUENWALD

05-7455
4 X 10 mm
SPURLING



05-7454 - 05-7455

150°

Upper part of jaw movable

05-7456
3 X 10 mm
LOVE-GRUENWALD

05-7457
4 X 10 mm
SPURLING

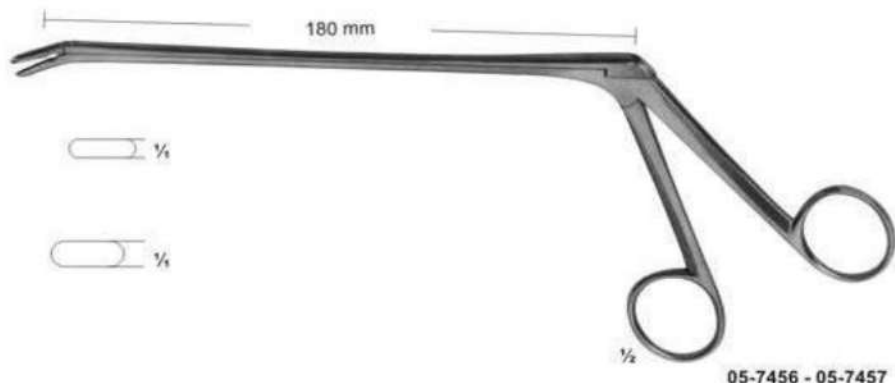

05-7456 - 05-7457

05-7458
∅ 7 mm



05-7458
OLDBERG

05-7459
YASARGIL
∅ 2,2 mm

05-7460
YASARGIL
∅ 3,5 mm



05-7459 - 05-7460

145 mm

05-7461
4 mm



Osteophyte Rongeur

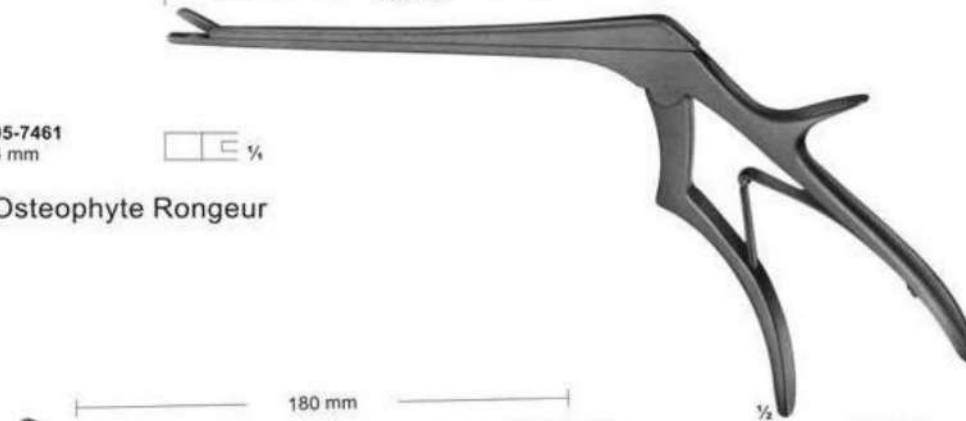

05-7461
CASPAR

180 mm

05-7462
4 mm



Osteophyte Rongeur

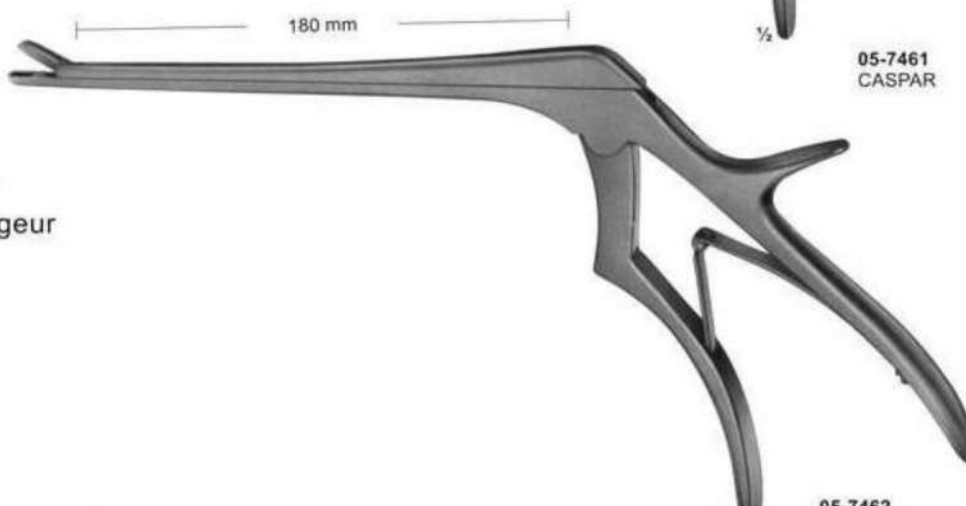

05-7462
CASPAR

200 mm

05-7463
5,5 mm



Very Heavy Pattern

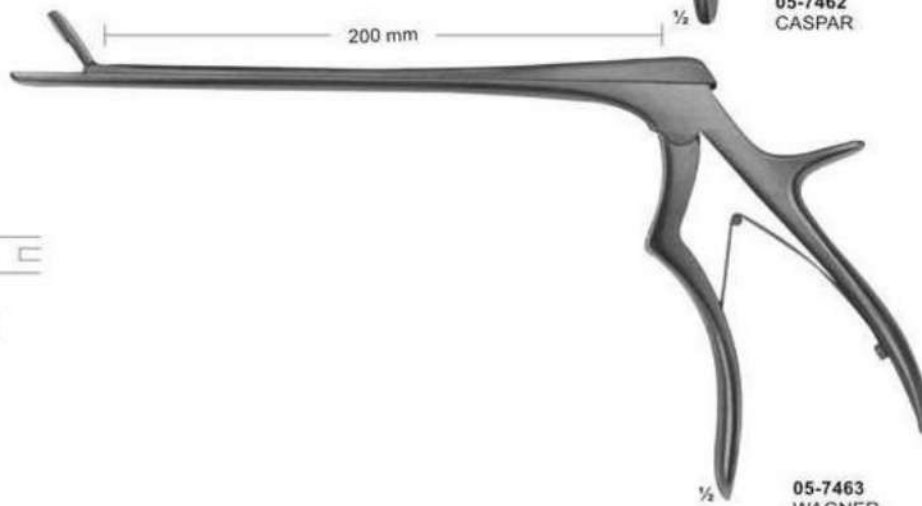

05-7463
WAGNER

Section - 06



Pages 319-392

- ★ Amputation, Elevators, Raspatories, Saws, Bone Livers, Bone Files & Curettes
- ★ Mallets, Tampers, Chisels, Gauges, Bone Holding Forceps, Bone Rongeurs, Bone Cutting Forceps, Meniscus Instruments
- ★ Wire Extension, Finger Nail Instruments

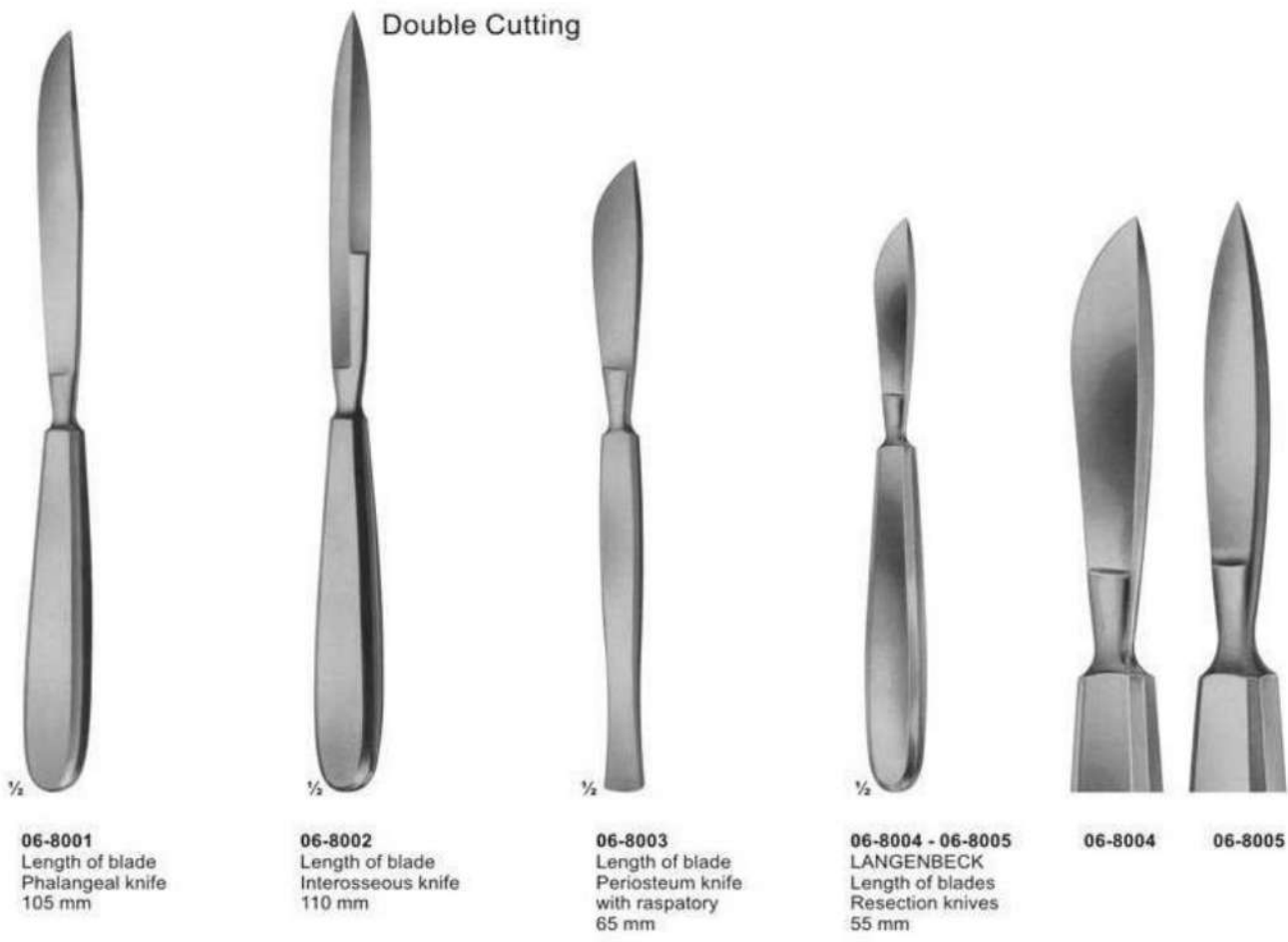

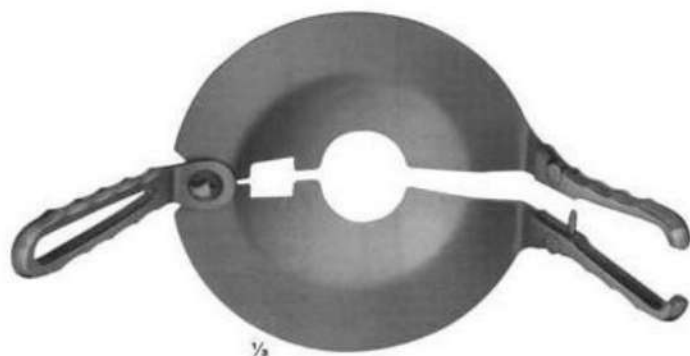

06-8006
PERCY
removeable handles

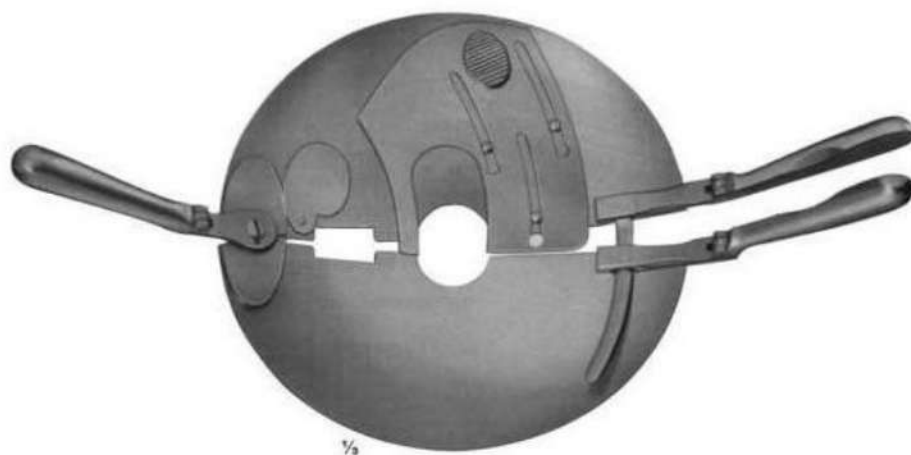

06-8007
PERCY
reversible handles



06-8008
CHARRIERE
 Length of blade
 215 mm
 complete with one saw
 blade each(**06-8009** and **06-8010**)
 350 mm

Spare saw blades, carbon steel
06-8009 12 mm
06-8010 20 mm



06-8011
RUST
 Length of blade
 235 mm
 complete with one saw
 blade each(**06-8013**, **06-8014**
 and 2 saw blades **06-8015**)
 390 mm
06-8012 Bow only

Spare saw blades, carbon steel
06-8013 6 mm
06-8014 8 mm
06-8015 12 mm
06-8016 20 mm

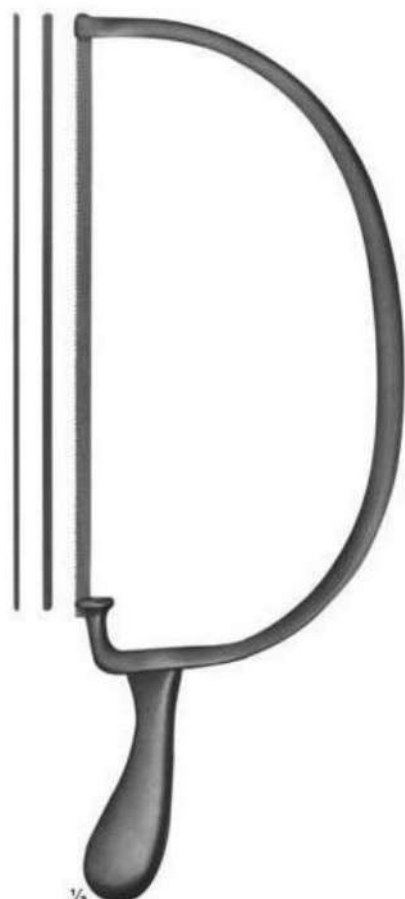

1/4

06-8017
BIER
Length of blade
270 mm
complete with one saw
blade each(**06-8018**, **06-8019** and **06-8020**)
420 mm

Spare saw blades, carbon steel
06-8018 4 mm
06-8019 6 mm
06-8020 8 mm



1/4

06-8021
CHARRIERE
Length of blade
180 mm
Spare saw blade,
carbon steel (**06-8022**)
270 mm

06-8023
CHARRIERE
Length of blade
240 mm
Spare saw blade,
carbon steel(**06-8024**)
340 mm



1/4

06-8025
SATTERLEE
Length of blade
200 mm
Spare saw blade,
carbon steel(**06-8026**)
200 mm



1/4

06-8027
LANGENBECK
Length of blade
115 mm
Metacarpal saw
235 mm

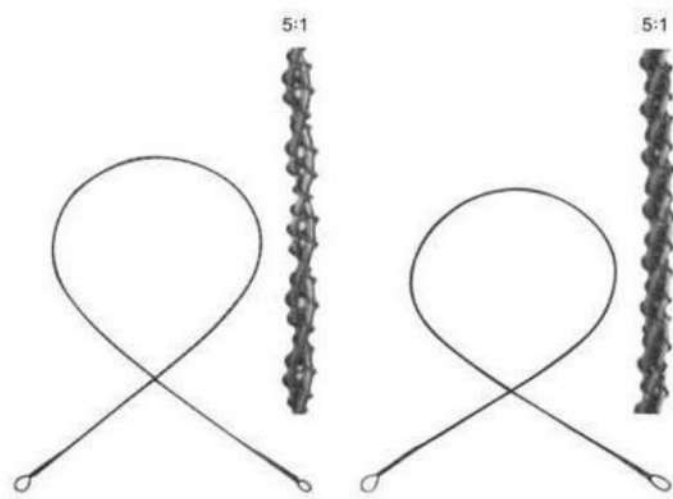

06-8028 - 06-8031
OLIVECRONA
06-8028 300 mm
06-8029 400 mm
06-8030 500 mm
06-8031 700 mm

06-8032 - 06-8035
GIGLI
06-8032 300 mm
06-8033 400 mm
06-8034 500 mm
fine, 6 wires twisted
06-8035 500mm
coarse, 4 wires twisted



06-8036
GIGLI
Handle



06-8037
LEBSCHE
Conductor for
wire saws, malleable
250 mm

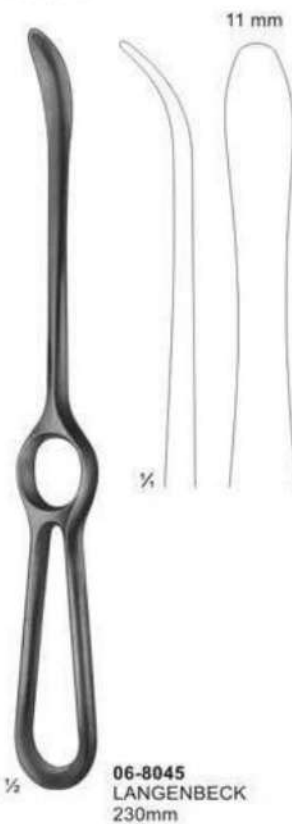
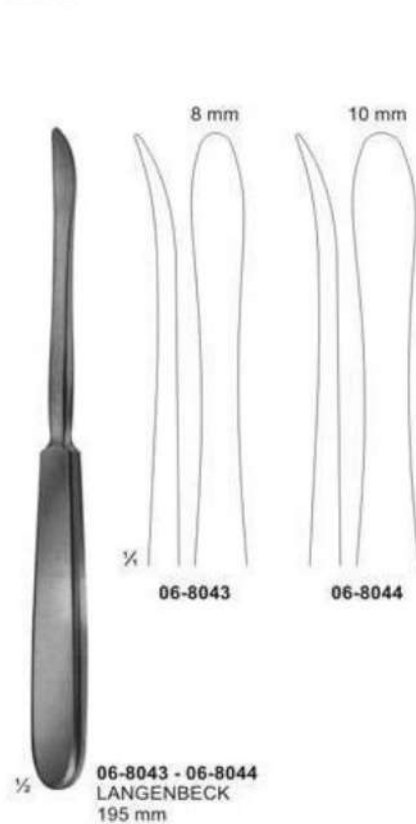
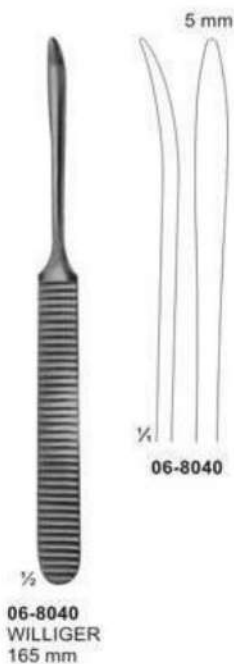
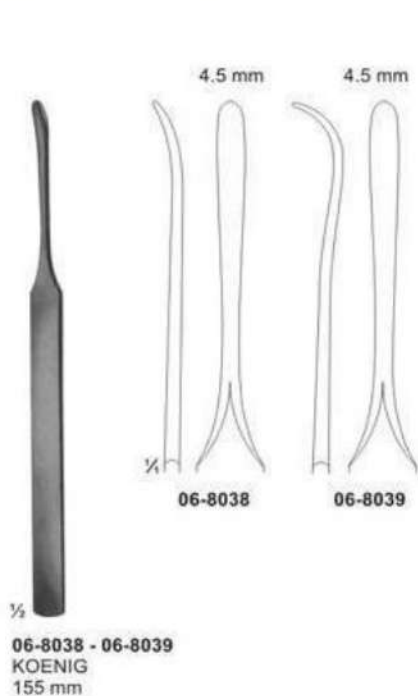



06-8046
140mm

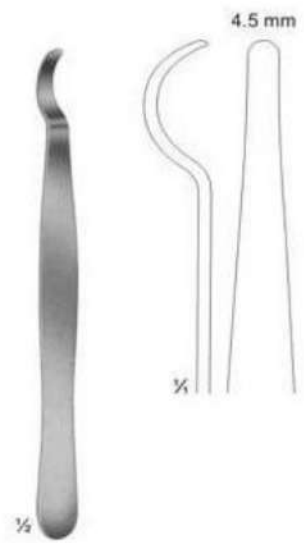

06-8047
150mm

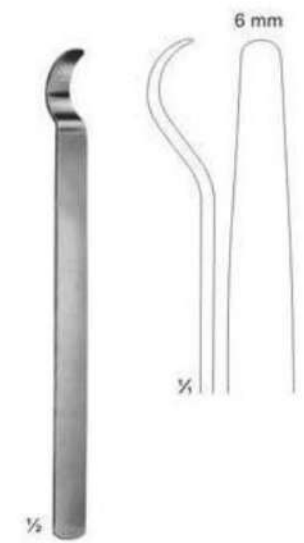

06-8048
150mm

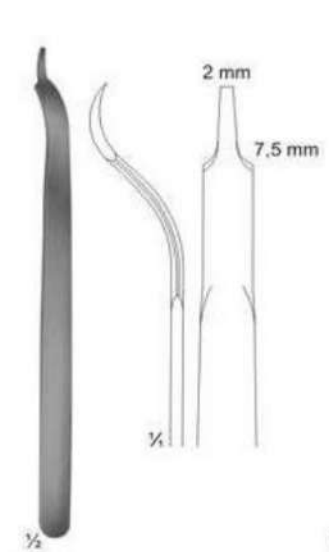

06-8049
BUCK-GRAMCKO
150mm



06-8050
160mm



06-8051
160mm

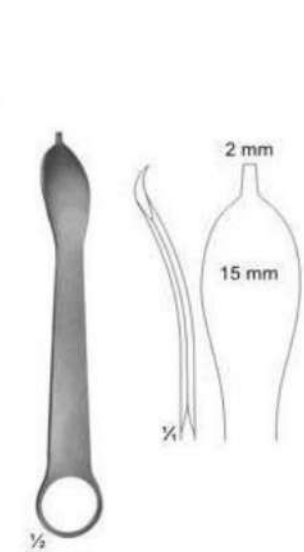

06-8052
125mm

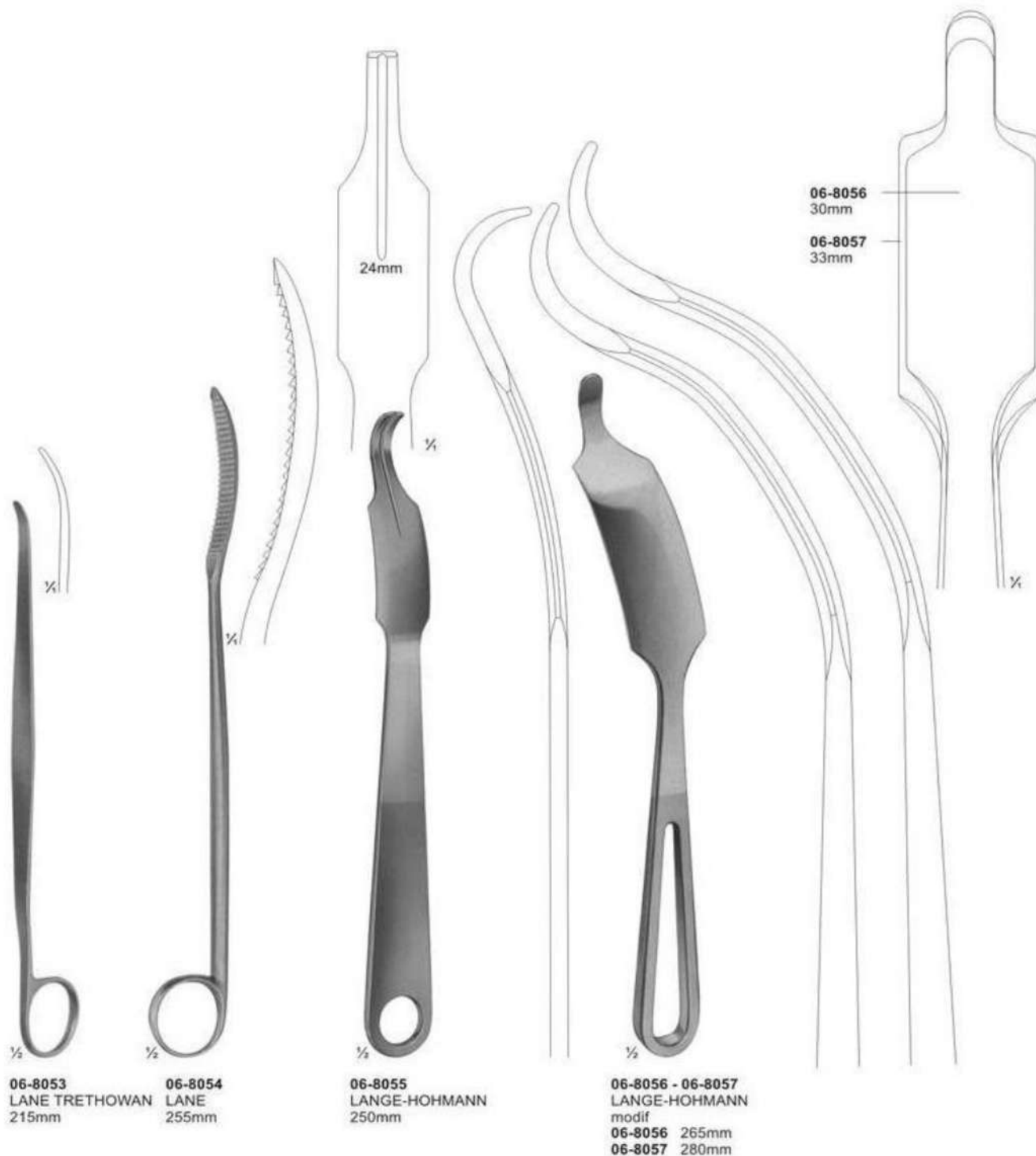



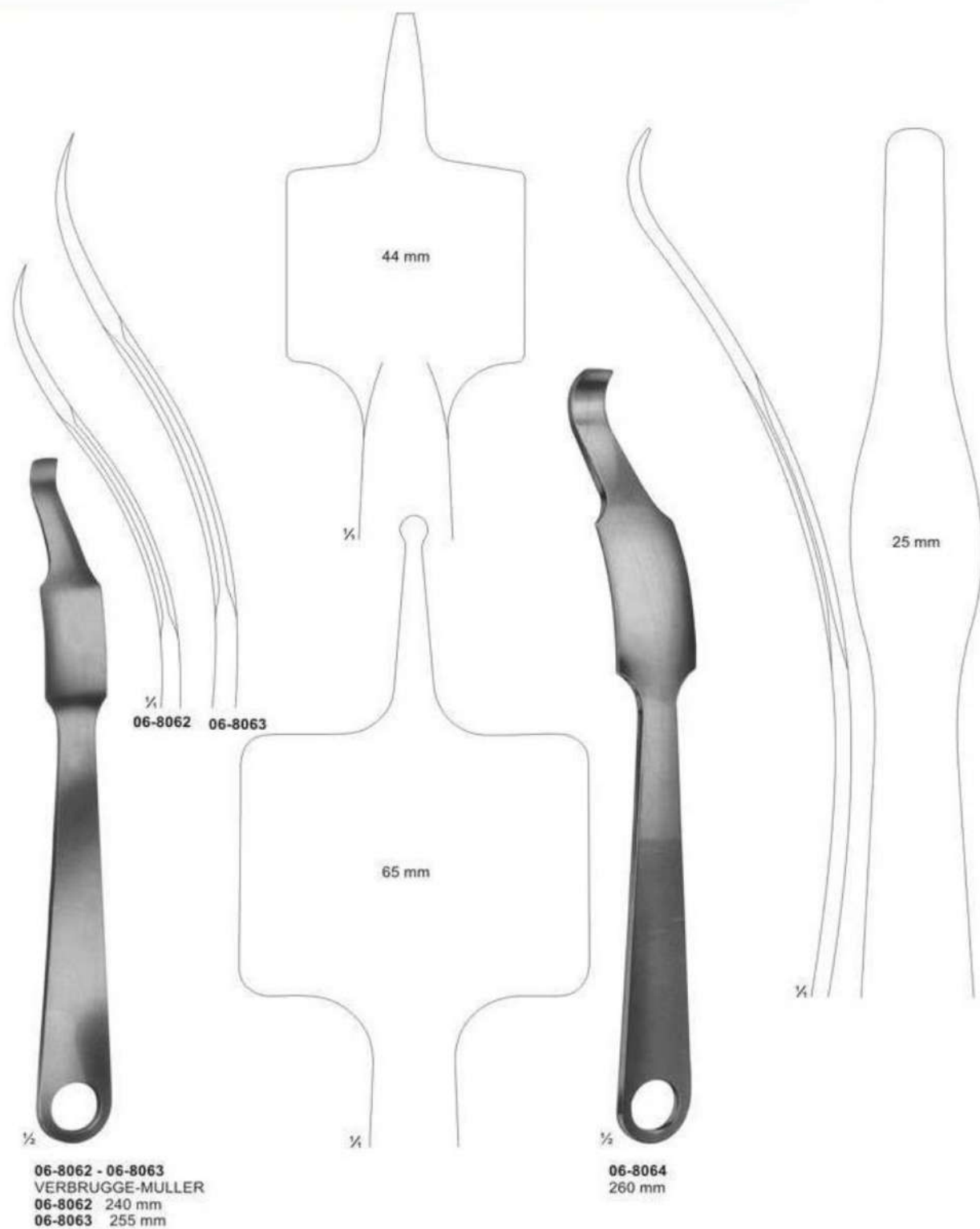

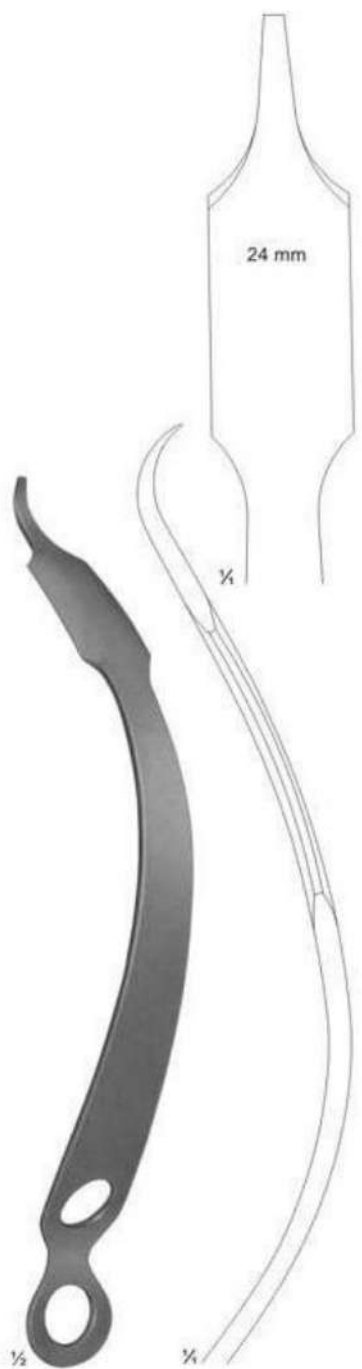

06-8065
HOHMANN-ALDINGER
270 mm



06-8066
SCHUMACHER mod. WAGNER
345 mm

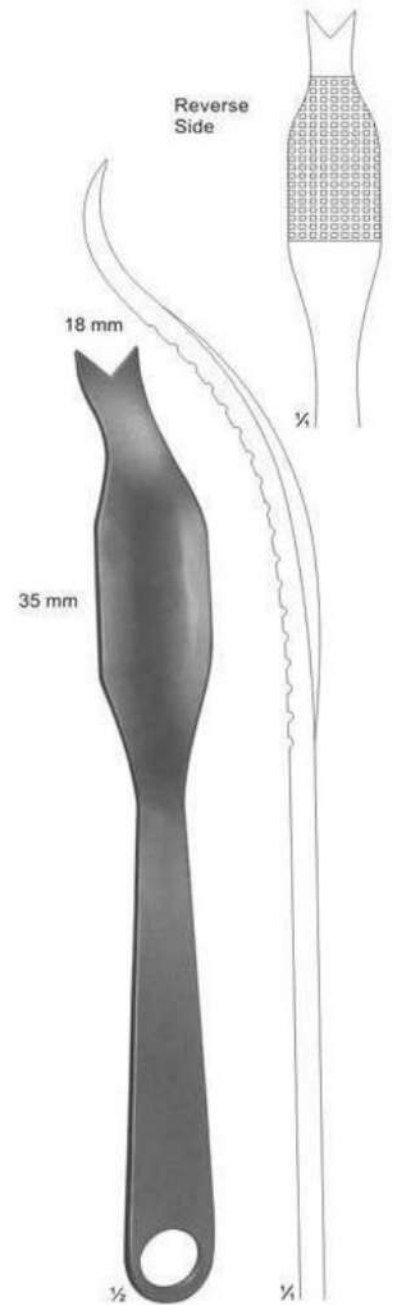

06-8067
SCHUMACHER
290 mm

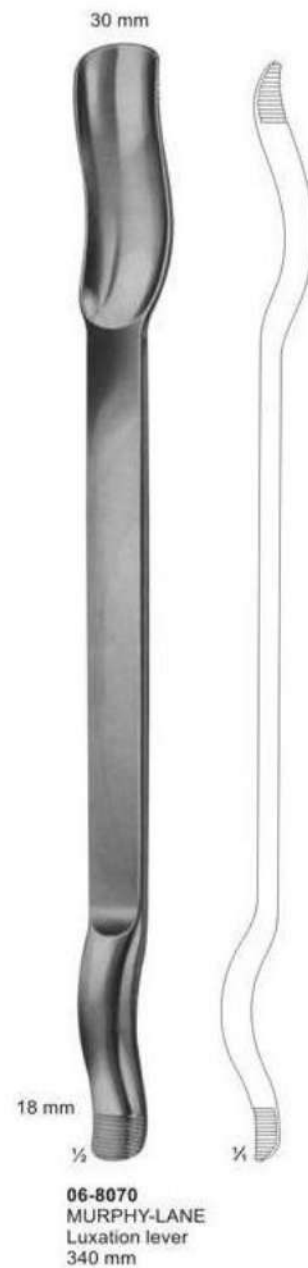

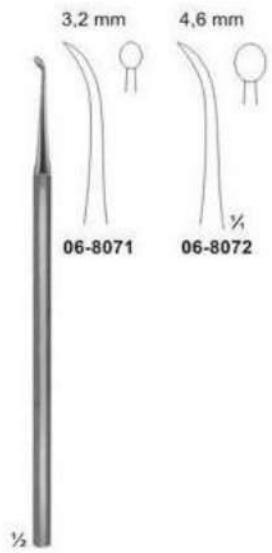

06-8071 - 06-8072
PARTSCH
150 mm

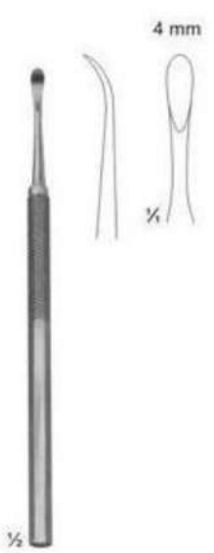

06-8073
PARTSCH mod. LANGE
145 mm



06-8074
MC KENTY
155 mm

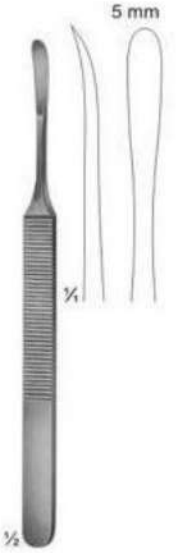

06-8075
KOENIG
155 mm

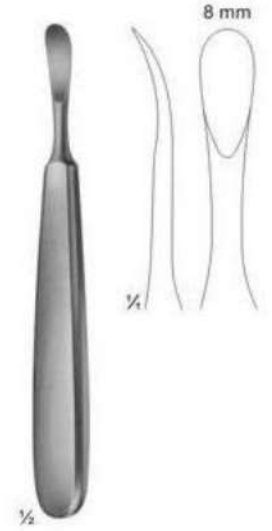

06-8076
TRELAT
150 mm

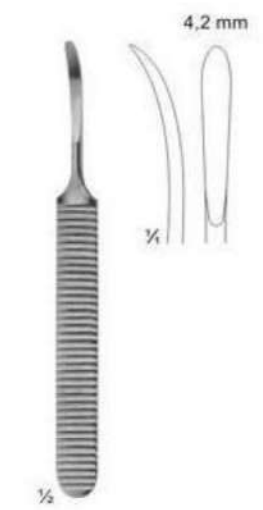

06-8077
WILLIGER
140 mm

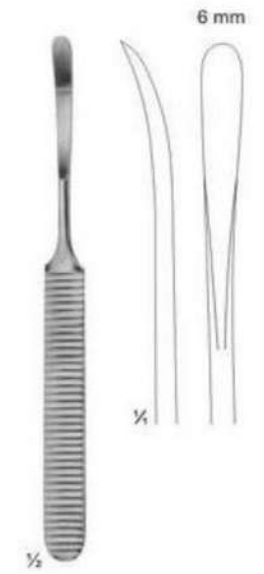

06-8078
WILLIGER
160 mm



06-8079
JOSEPH
170 mm

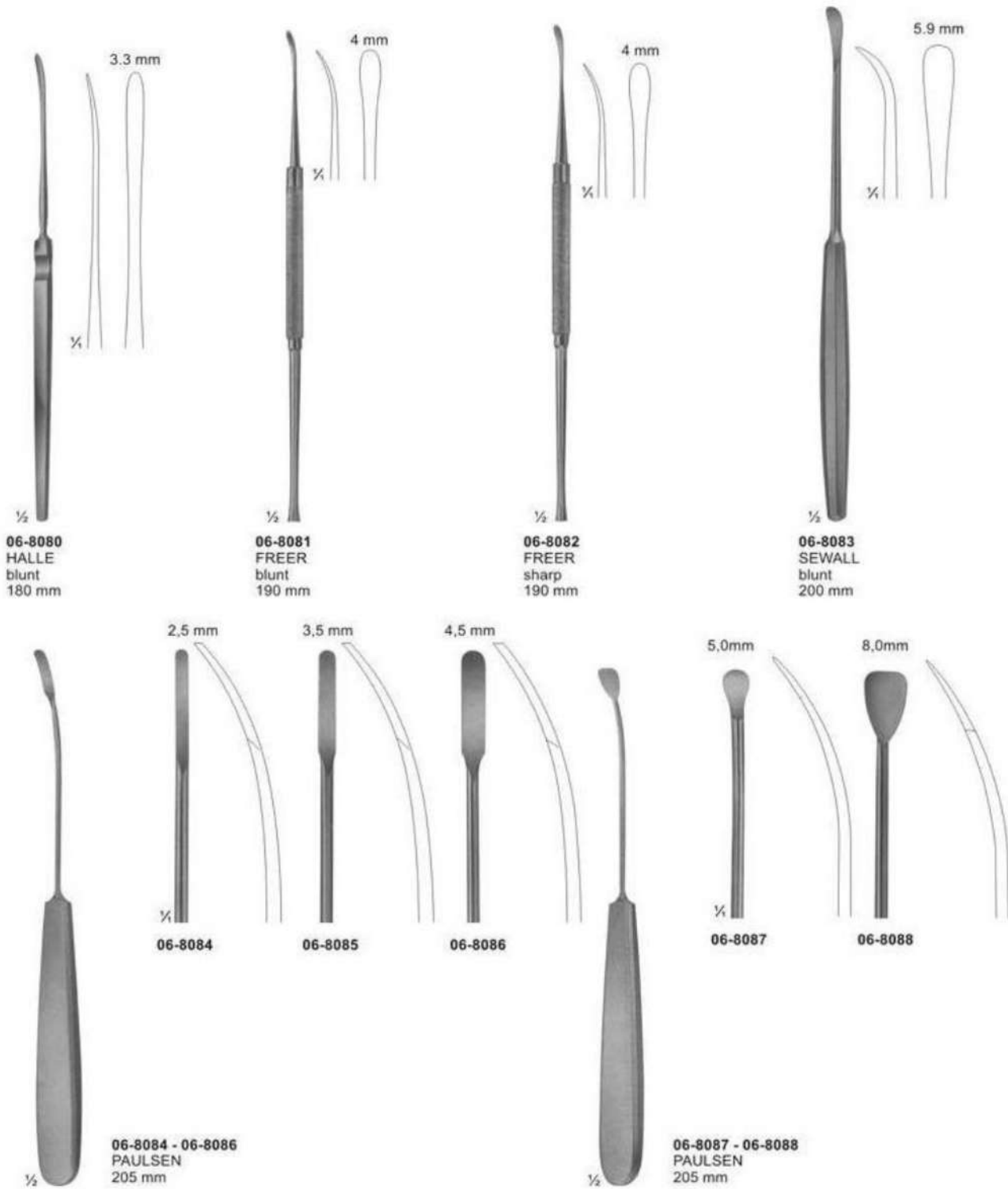



06-8089
KILLIAN
sharp/blunt
185 mm

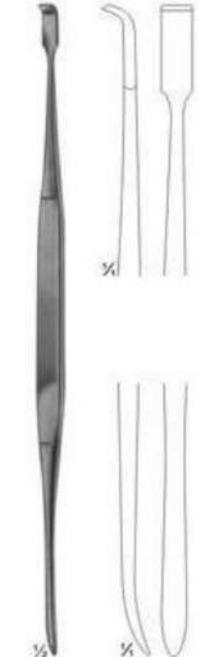

06-8090
HOWARTH
sharp/blunt
215 mm



06-8091
KILLIAN
sharp/blunt
185 mm

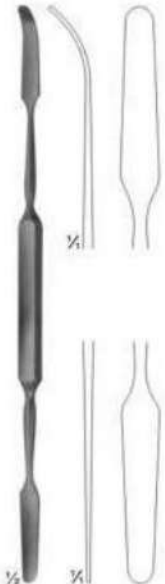

06-8092
MAC DONALD
blunt/blunt
185 mm

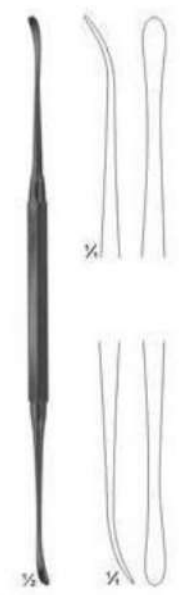

06-8093
FREER
sharp/blunt
185 mm

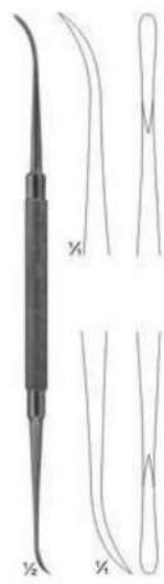

06-8094
FREER-YASARGIL
sharp/sharp
185 mm



06-8095
COTTLE
sharp/sharp
200 mm



06-8096
MEAD
sharp/sharp
165 mm



06-8097
MOLT
sharp/sharp
180 mm

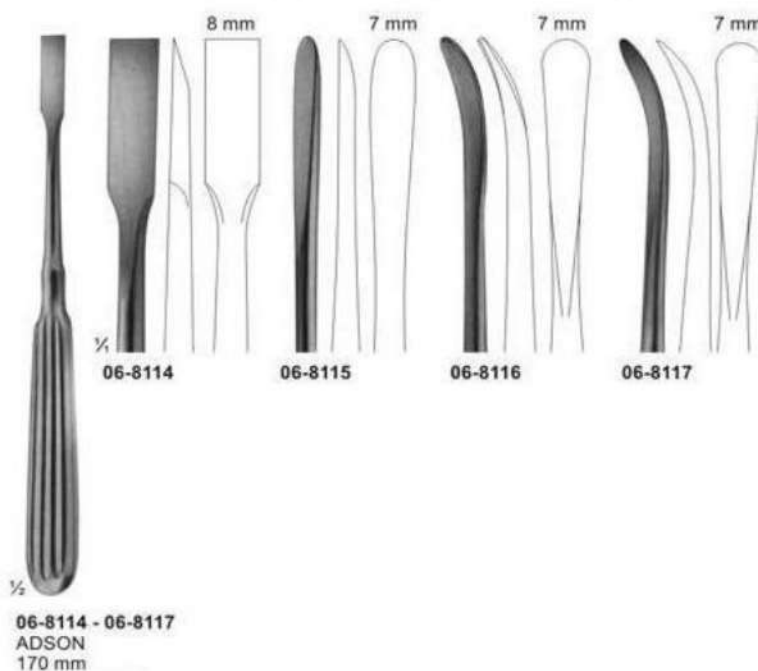
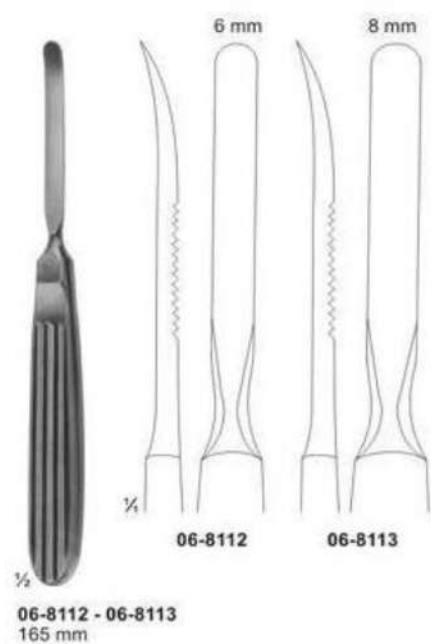
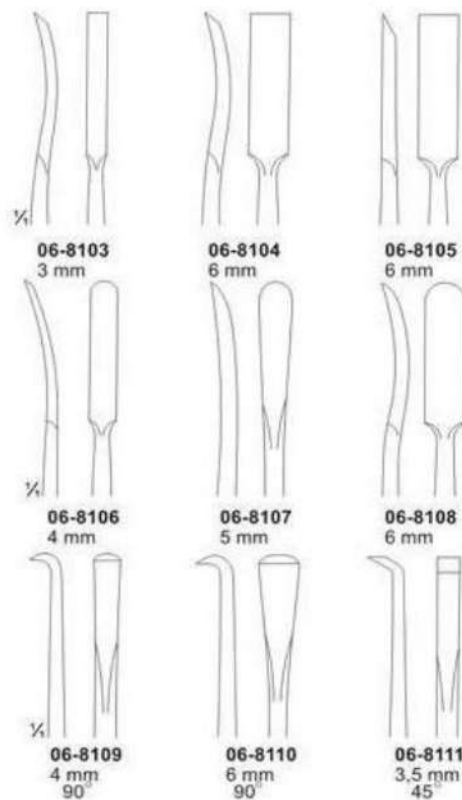
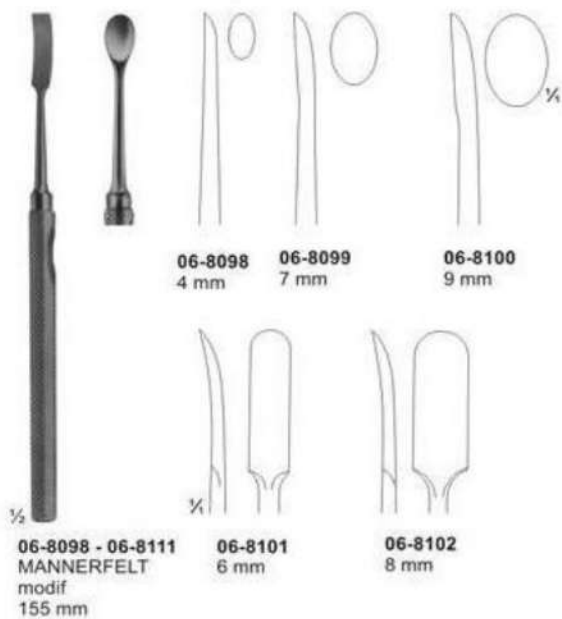

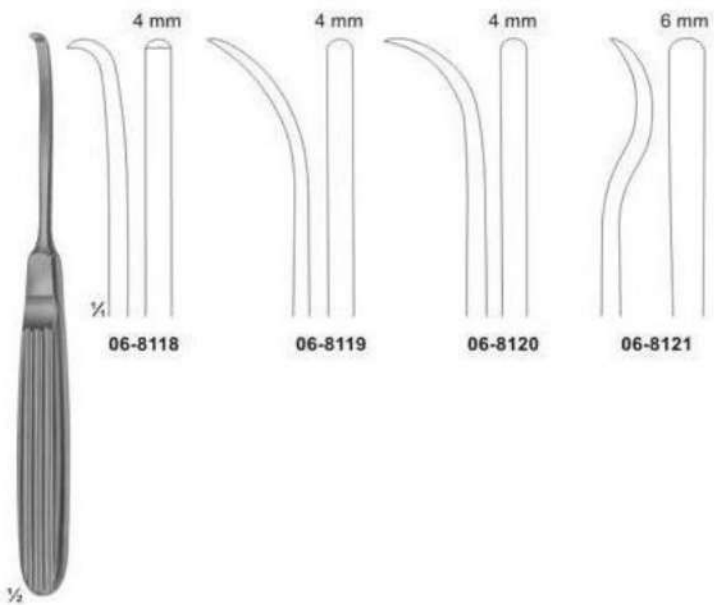

06-8118 - 06-8121
MUEHLING
170 mm

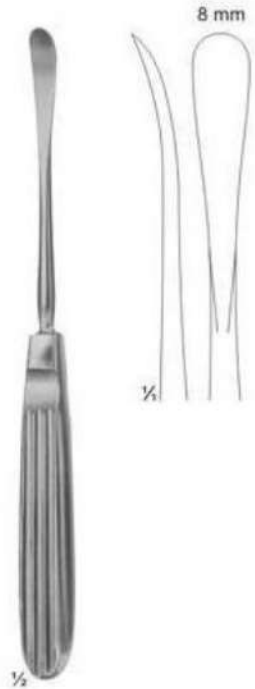

06-8122
COTTLE
195 mm

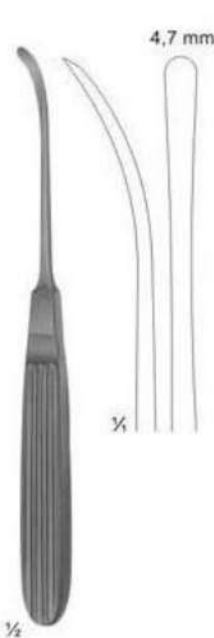

06-8123
LANDOLT
175 mm

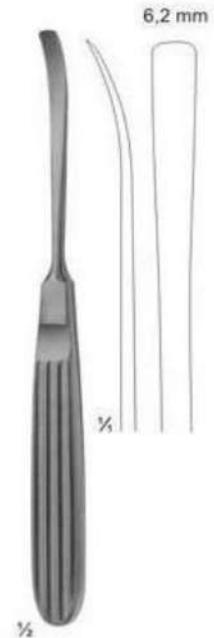

06-8124
CASPAR
180 mm

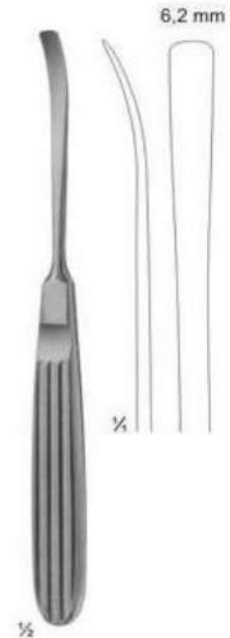

06-8125
CASPAR
180 mm

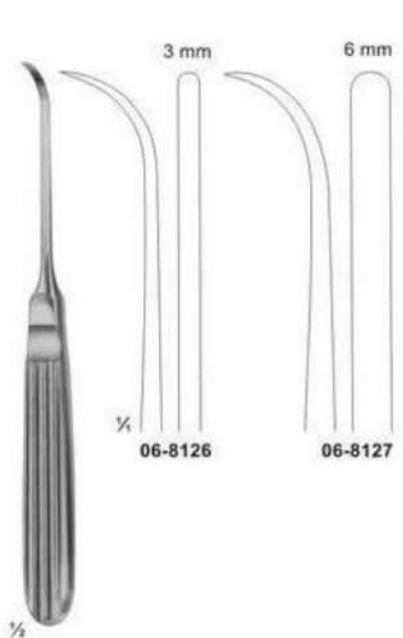

06-8126 - 06-8127
170 mm



06-8128
FARABEU
140 mm



06-8129
FARABEU
140 mm



06-8130
JANSEN
165 mm

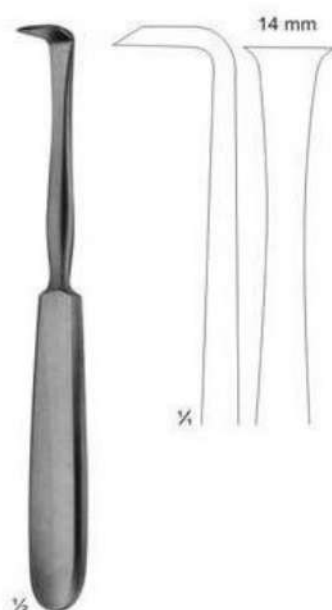

06-8131
LANGENBECK
180 mm

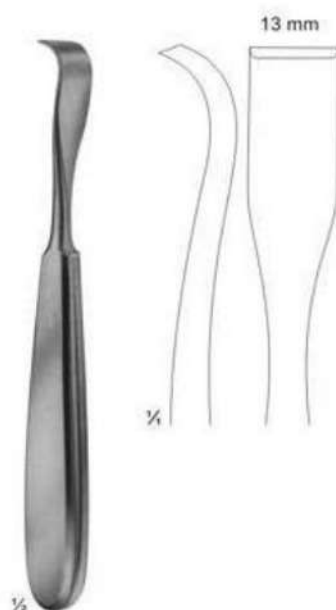

06-8132
SCHNEIDER
175 mm

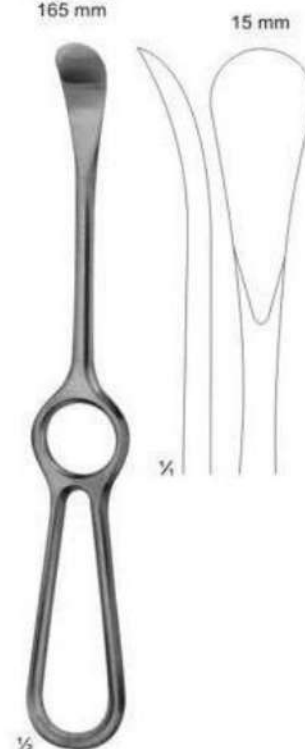

06-8133
SEDILOT
215 mm

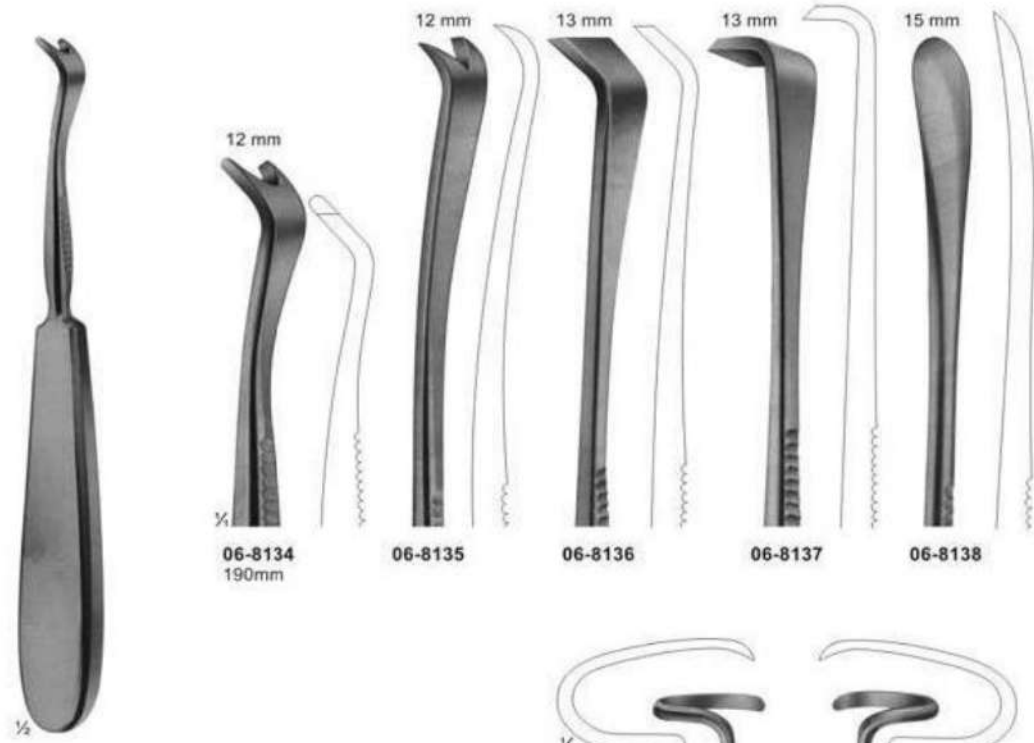

06-8134 190mm 06-8135 06-8136 06-8137 06-8138

06-8134 - 06-8138
SEMB
230 mm



06-8143 06-8144



06-8139 - 06-8140
DOYEN for children
06-8141 - 06-8142
for adults 175 mm

06-8143 - 06-8144
DOYEN
240 mm

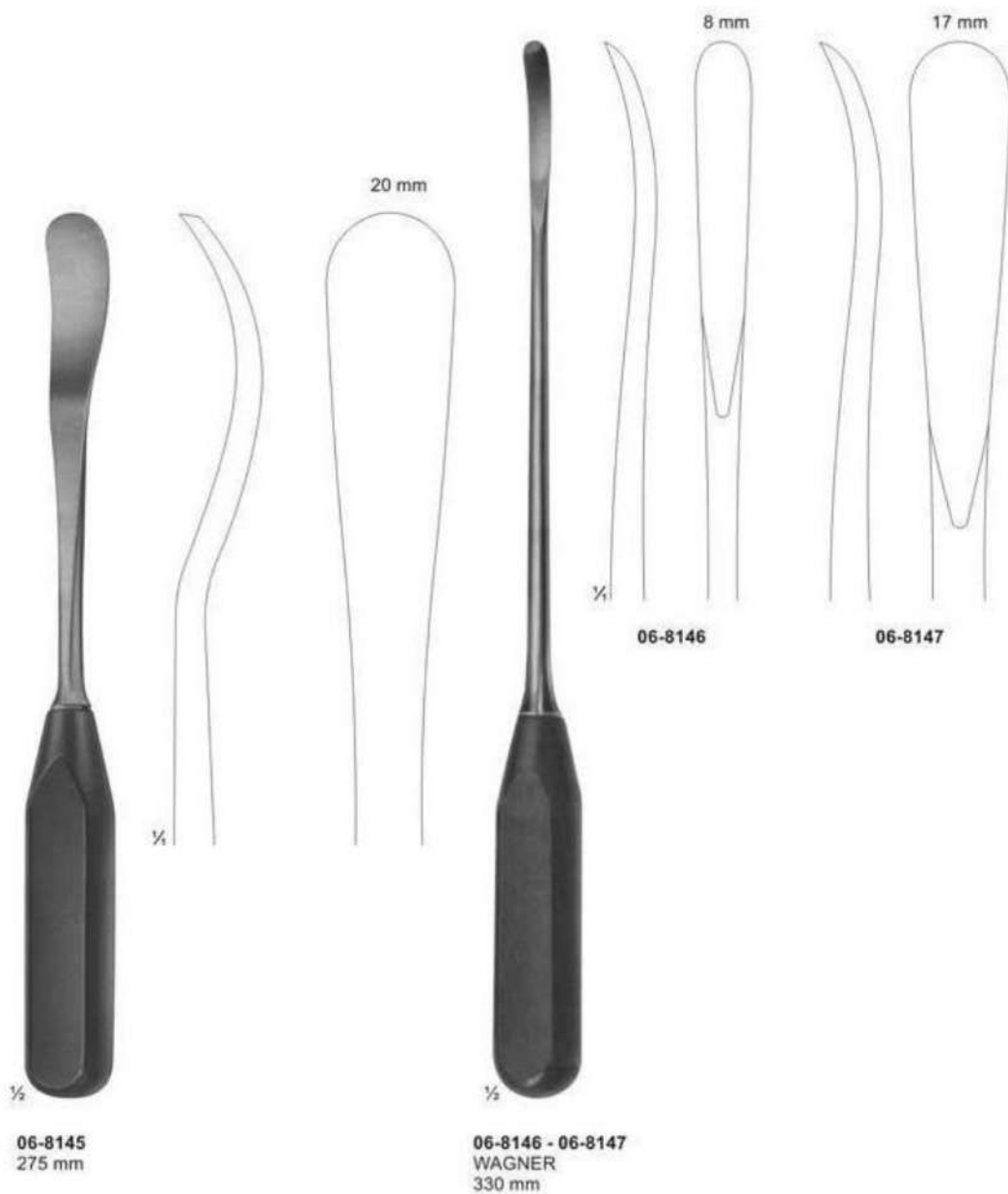



7.5 mm

9 mm

1/2

06-8148

06-8149

06-8148
JOSEPH
fine, chequered

06-8149
coarse, chequered
165 mm



9 mm

1/2

06-8152

MALTZ
down stroke
180 mm

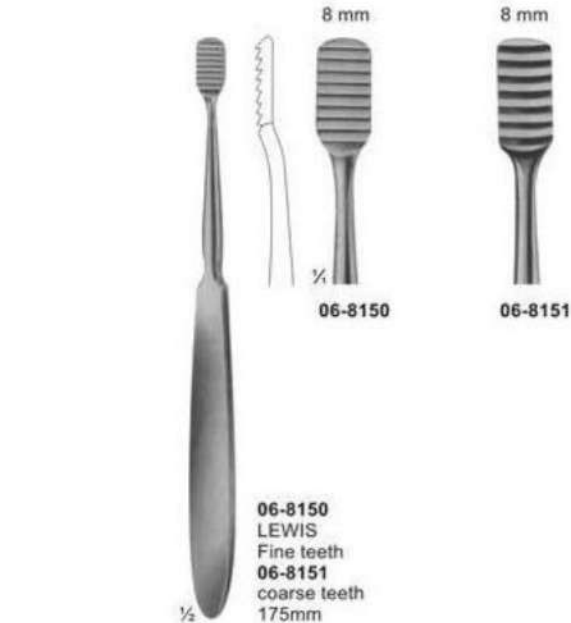

8 mm

8 mm

1/2

06-8150

06-8151

06-8150
LEWIS
Fine teeth
06-8151
coarse teeth
175mm



9 mm

9 mm

1/2

06-8153

06-8154

1/2

06-8153
AUFRICT
up stroke
06-8154
down stroke
220 mm



6.5 mm

1/2

1/2

06-8155
GALLAHER
190 mm

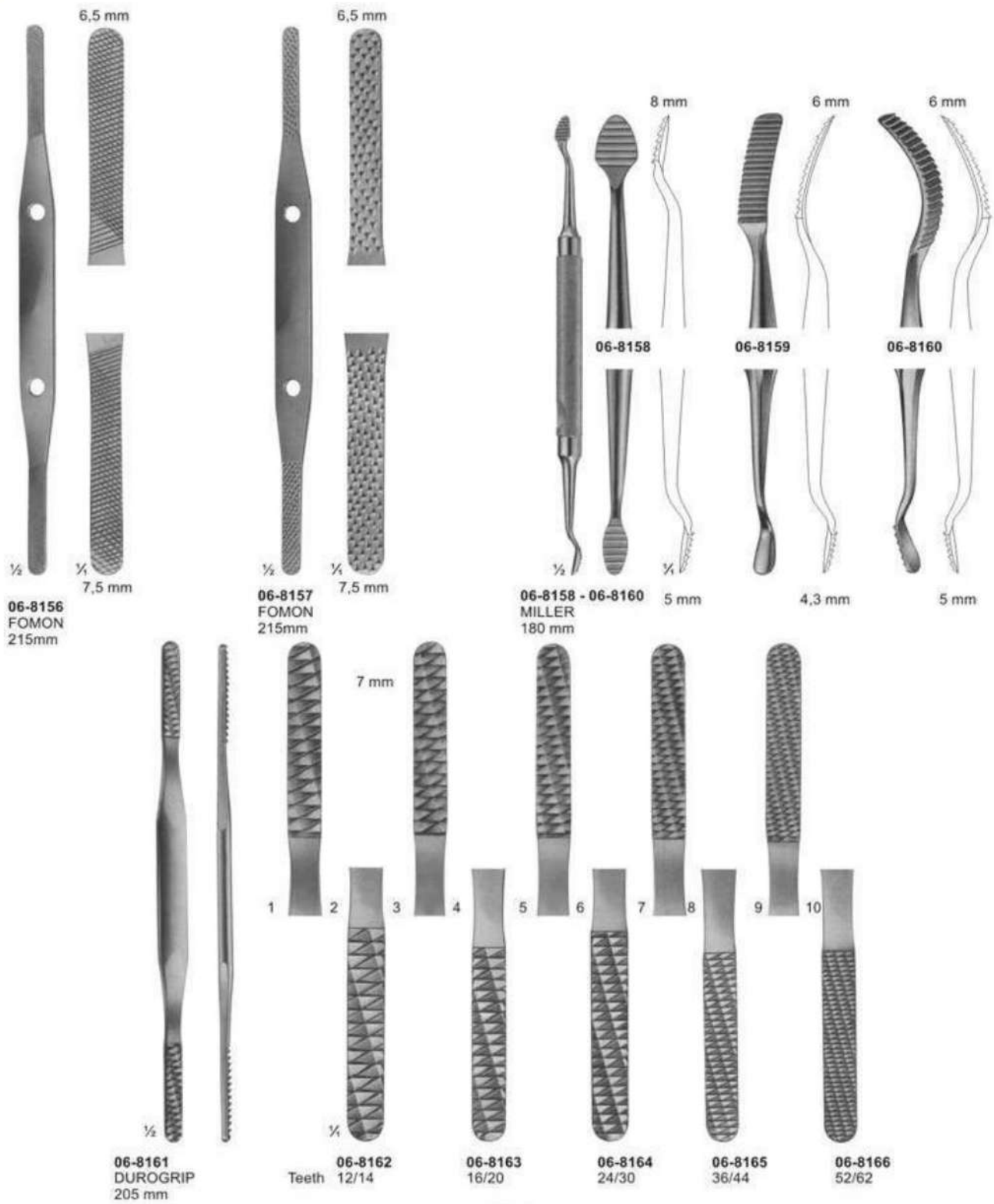

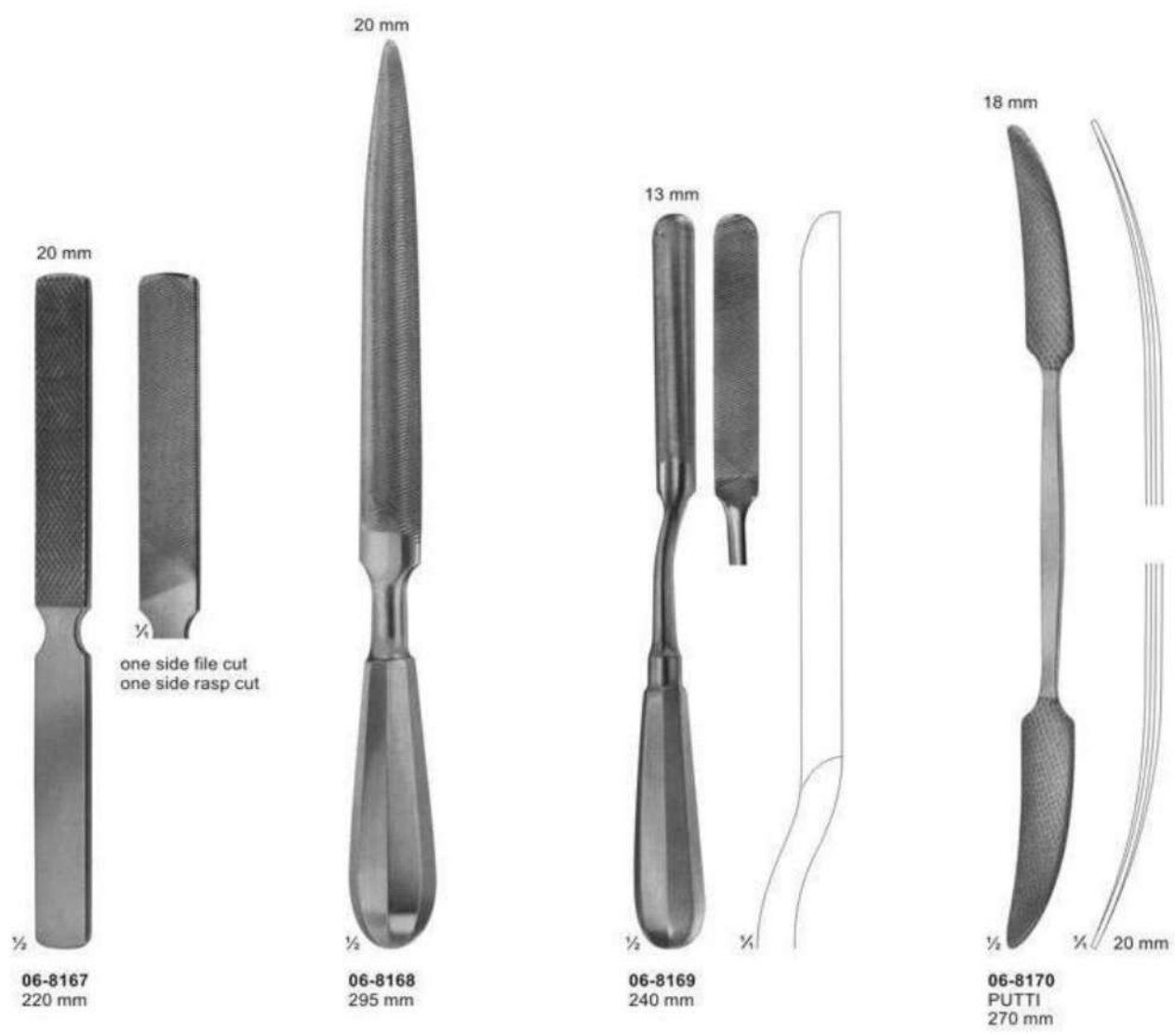

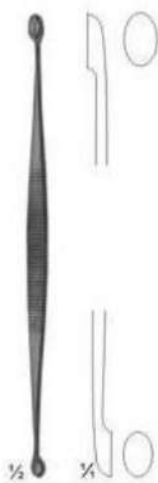

06-8171
JACOBSON
140 mm



06-8172
MARTINI
140 mm



06-8173
MARTINI
140 mm



06-8174
WILLIGER
145 mm



06-8175
JANSEN
160 mm



06-8176
BARTH
180 mm



06-8177
VOLKMANN
130 mm



06-8178
VOLKMANN
145 mm



06-8179
VOLKMANN
170 mm

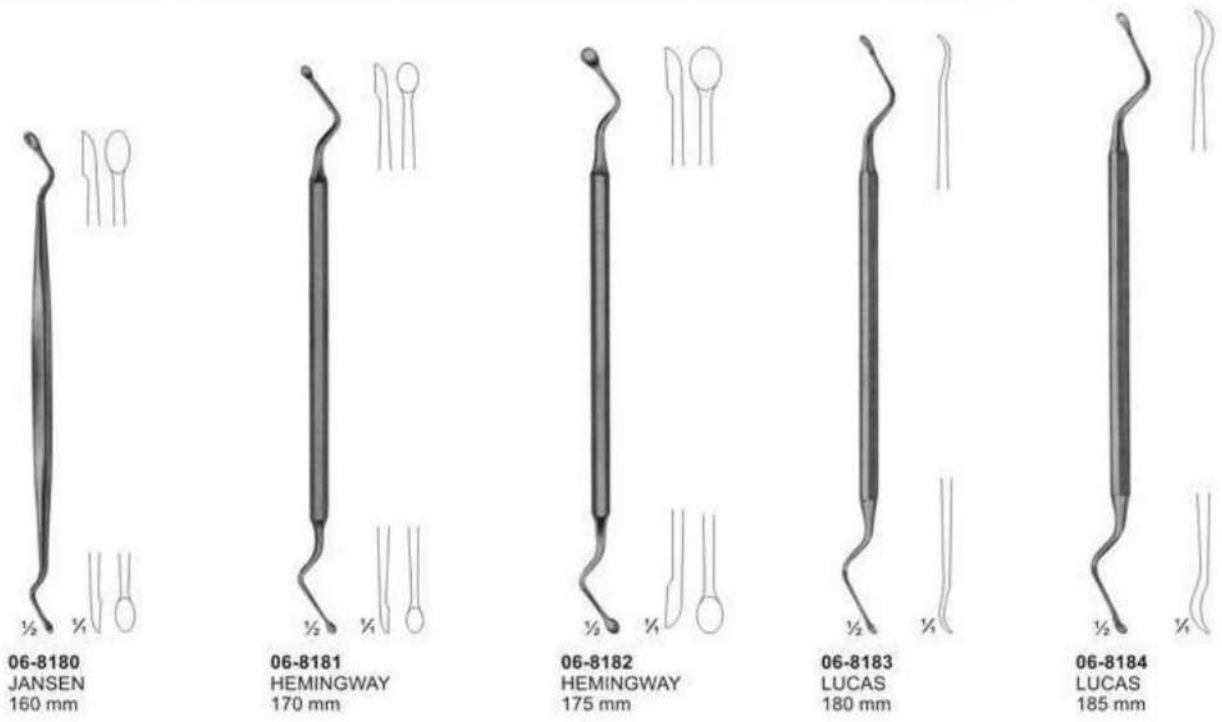

06-8180
JANSEN
160 mm

06-8181
HEMINGWAY
170 mm

06-8182
HEMINGWAY
175 mm

06-8183
LUCAS
180 mm

06-8184
LUCAS
185 mm



06-8185 - 06-8187
KERPEL
145 mm

06-8186 - 06-8188
KERPEL
145 mm

06-8189
UFFENORDE
170 mm

06-8190
UFFENORDE
170 mm

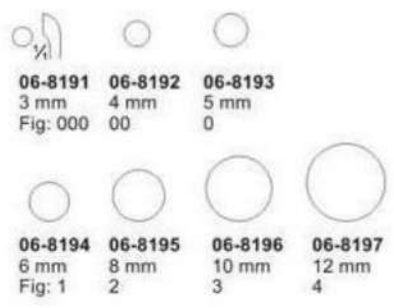
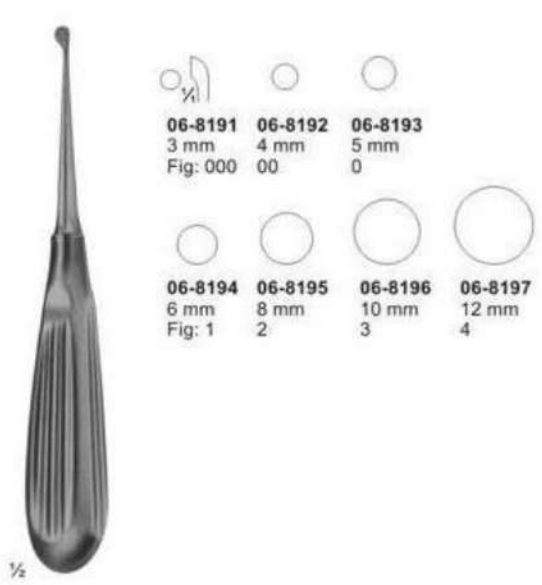

06-8191 - 06-8197
BRUNS
165 mm

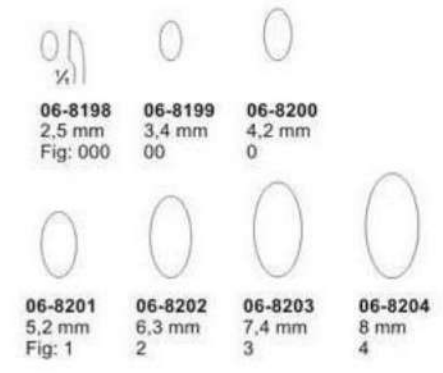

06-8198 - 06-8204
SCHEDE
170 mm

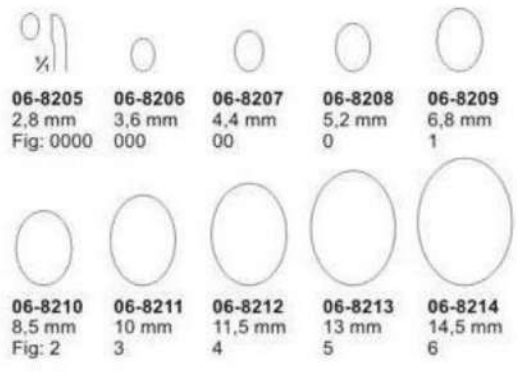
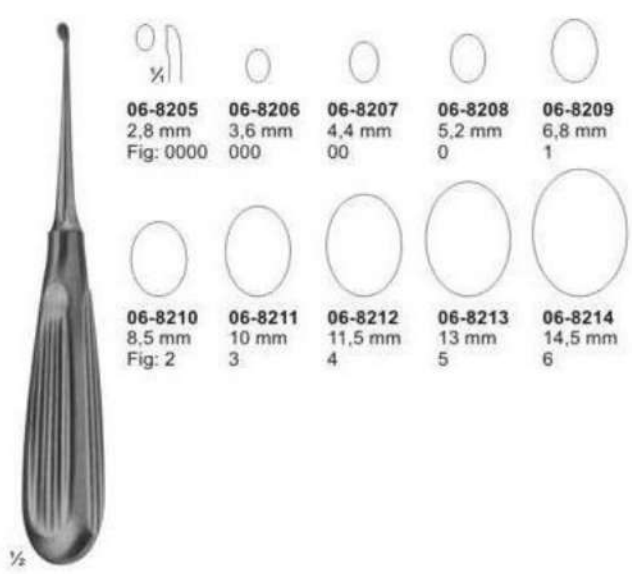

06-8205 - 06-8214
VOLKMANN
170 mm

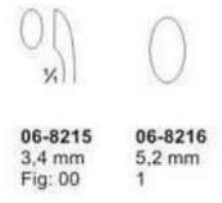

06-8215 - 06-8216
WILLIGER
170 mm



06-8217 - 06-8221
LEMPERT
215 mm

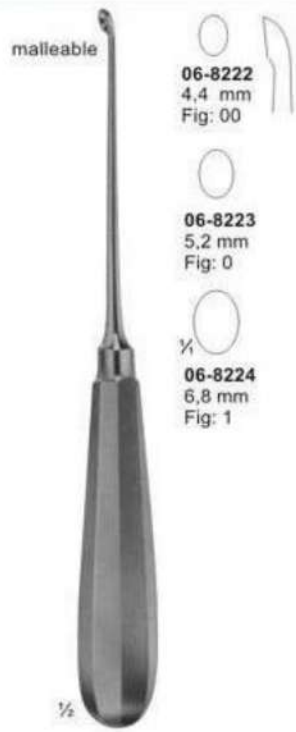

06-8222 - 06-8224
HALLE
215 mm

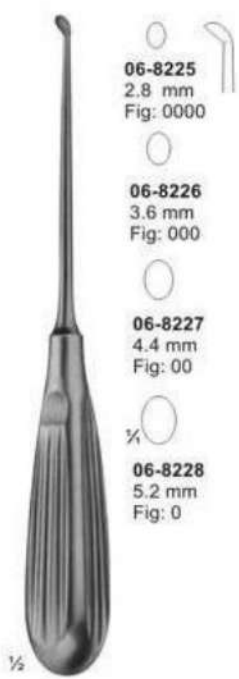

06-8225 - 06-8228
DAUBENSPECK
200 mm

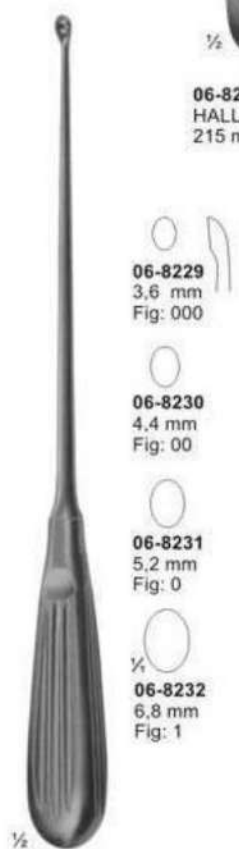

06-8229 - 06-8232
250 mm



06-8233 - 06-8236
250 mm



06-8237 - 06-8239
BUSHE 250 mm

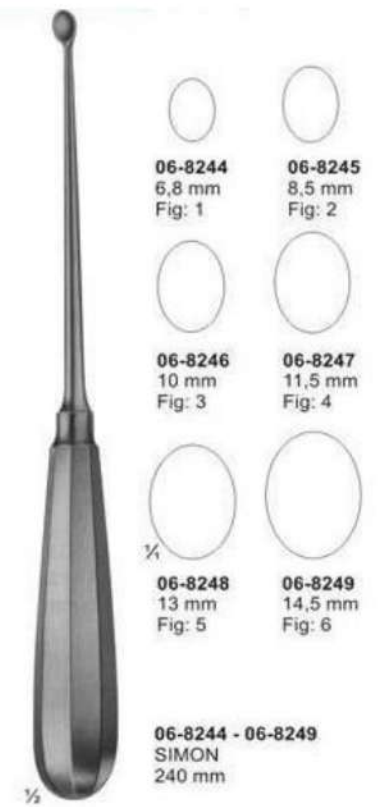

can be sterilized in a steam sterilizer upto 3 bar over pressure (143 C).



4,4 mm
Fig. 00
06-8259

6,8 mm
Fig. 1
06-8260

8,5 mm
Fig. 2
06-8261

10 mm
Fig. 3
06-8262

$\frac{1}{2}$

06-8259 - 06-8262
270 mm



2,8 mm
Fig. 0000
06-8263

3,6 mm
Fig. 000
06-8264

5,2 mm
Fig. 0
06-8265

10,0 mm
Fig. 3
06-8266

2,8 mm
Fig. 0000
06-8267

3,6 mm
Fig. 000
06-8268

5,2 mm
Fig. 0
06-8269

10,0 mm
Fig. 3
06-8270

$\frac{1}{2}$

06-8263 - 06-8270
SYPERT
380 mm



06-8271
MEAD
185 g
with interchangeable
plastic disks
190 mm
06-8272
pair of spare disks



06-8273
140 g
with interchangeable
plastic disks
185 mm
06-8274
pair of spare disks



06-8275
COTTLE
240 g
1 Side flat
1 Side convex
185 mm



06-8276
165 g
lead filled head
190 mm



06-8277
HAJEK
140 g
220 mm



06-8278
215 g
with interchangeable
plastic disks
245 mm
06-8279
pair of spare disks

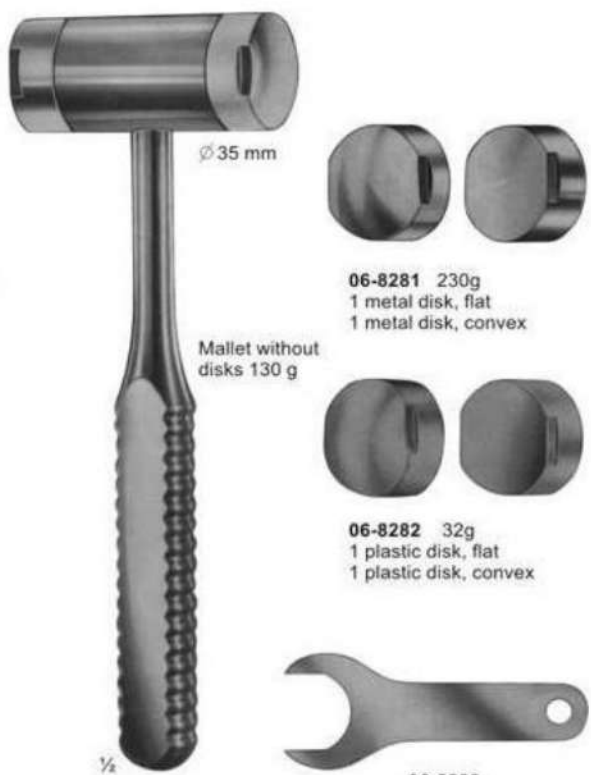

06-8280 - 06-8283
WAGNER
complete with:
1 pair of metal disks (**06-8281**) and
1 pair of plastic disks(**06-8282**) and
1 wrench (**06-8283**)
235 mm

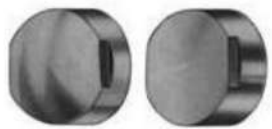

06-8281 230g
1 metal disk, flat
1 metal disk, convex



06-8282 32g
1 plastic disk, flat
1 plastic disk, convex



06-8283
Wrench



∅ 45 mm

½

06-8284 300g
BERGMANN
245 mm



∅ 30 mm

½

06-8285 300g
BERGMANN
235 mm



∅ 40 mm

½

06-8286 550g
OMBREDANNE
240 mm



∅ 40 mm

½

06-8287
HEATH
copper filled head
700 g
185 mm



06-8288
HAASE
100 mm



06-8289 - 06-8290
PASSOW
120 mm



06-8291 - 06-8293
CASPAR
200 mm

- **06-8291**
∅ 3 mm
- **06-8292**
∅ 5 mm
- **06-8293**
∅ 8 mm



06-8294 - 06-8296
200 mm

- **06-8294**
∅ 12 mm
- **06-8295**
∅ 14 mm
- **06-8296**
∅ 16 mm



06-8297 4mm
FREER
Chisel
160 mm



06-8298 4mm
FREER
Chisel, curved
160 mm



06-8299 6mm
FREER
Gouge
150 mm



06-8300 3.4mm
Scaphoid gouge,
downwards curved
135 mm



06-8301 3.4mm
Scaphoid gouge,
upwards curved
135 mm



06-8302 - 06-8304
MANNERFELT modif
Osteotomes
06-8302 4 mm
06-8303 6 mm
06-8304 8 mm
155 mm

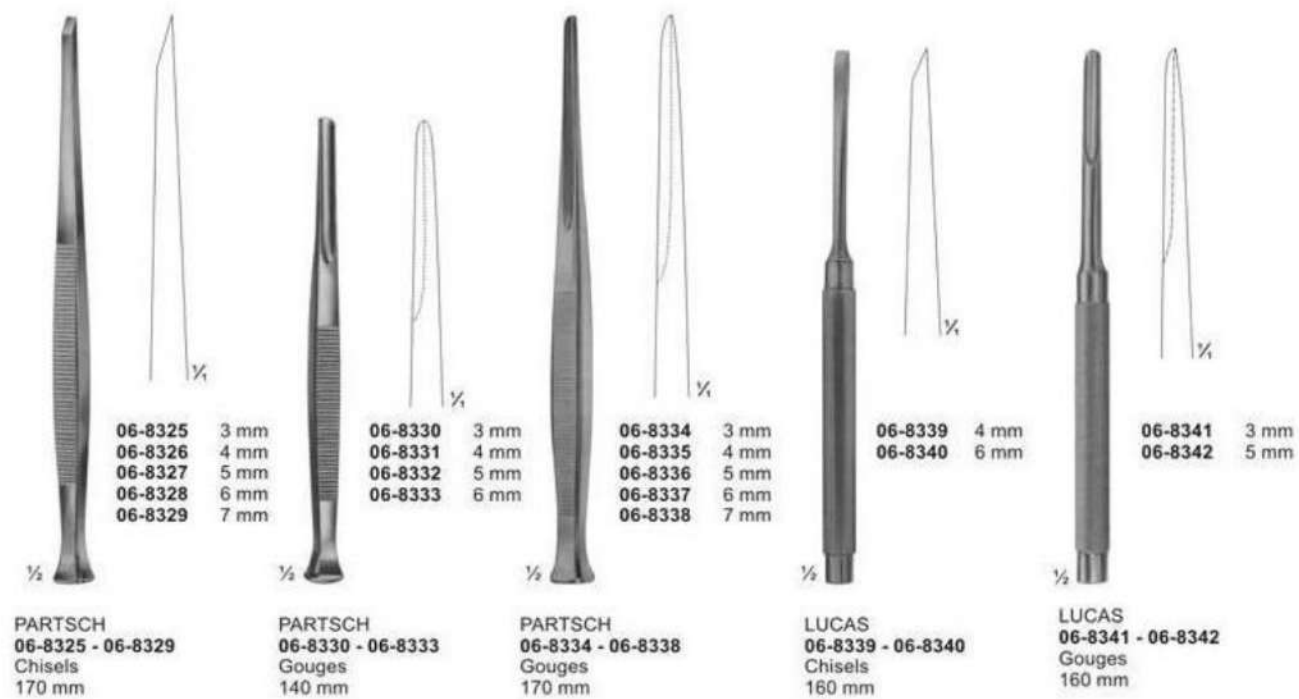
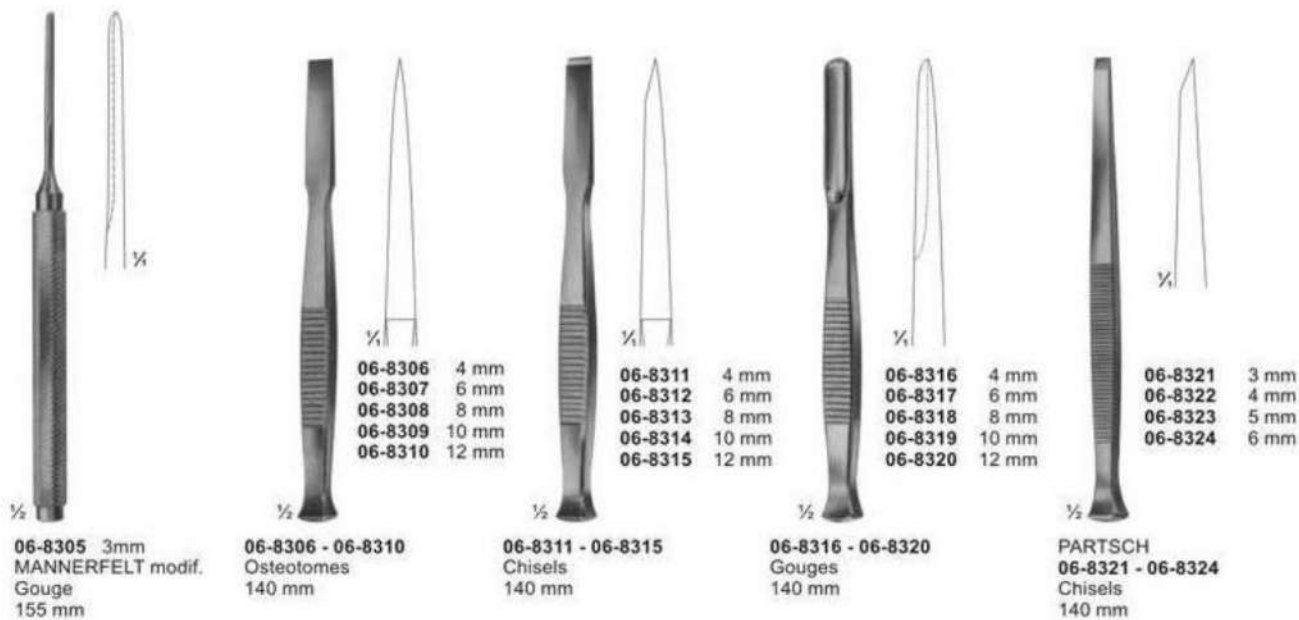

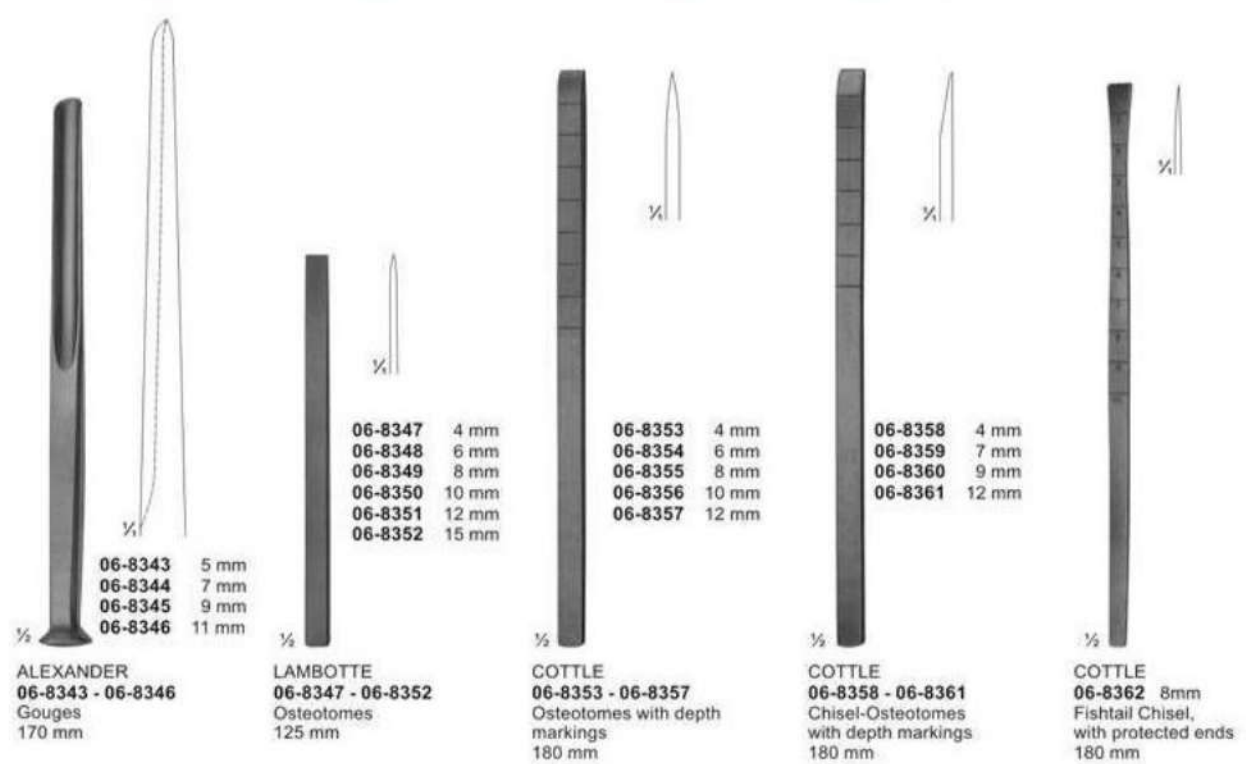

Model	Part Numbers	Dimensions
ALEXANDER 06-8343 - 06-8346 Gouges 170 mm	06-8343	5 mm
	06-8344	7 mm
	06-8345	9 mm
	06-8346	11 mm
LAMBOTTE 06-8347 - 06-8352 Osteotomes 125 mm	06-8347	4 mm
	06-8348	6 mm
	06-8349	8 mm
	06-8350	10 mm
	06-8351	12 mm
06-8352	15 mm	
COTTLE 06-8353 - 06-8357 Osteotomes with depth markings 180 mm	06-8353	4 mm
	06-8354	6 mm
	06-8355	8 mm
	06-8356	10 mm
	06-8357	12 mm
COTTLE 06-8358 - 06-8361 Chisel-Osteotomes with depth markings 180 mm	06-8358	4 mm
	06-8359	7 mm
	06-8360	9 mm
	06-8361	12 mm
COTTLE 06-8362 Fishtail Chisel, with protected ends 180 mm		8 mm

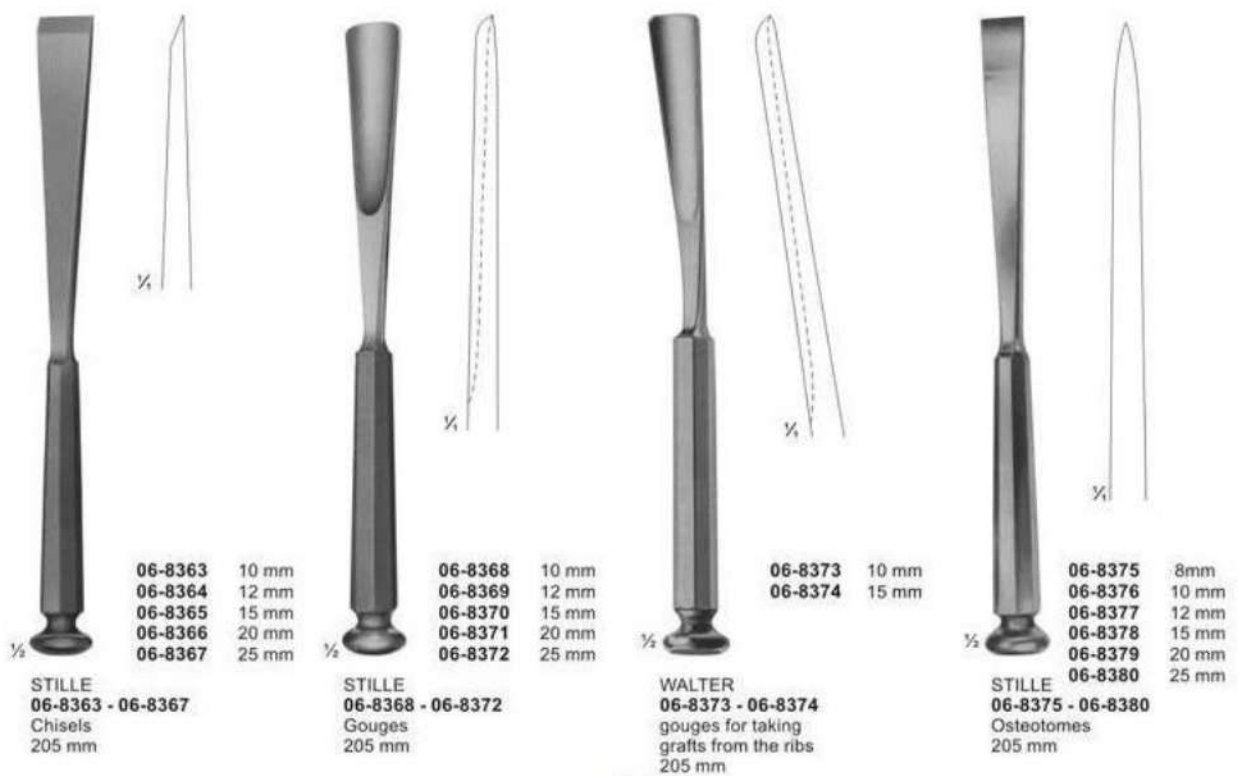

Model	Part Numbers	Dimensions
STILLE 06-8363 - 06-8367 Chisels 205 mm	06-8363	10 mm
	06-8364	12 mm
	06-8365	15 mm
	06-8366	20 mm
	06-8367	25 mm
STILLE 06-8368 - 06-8372 Gouges 205 mm	06-8368	10 mm
	06-8369	12 mm
	06-8370	15 mm
	06-8371	20 mm
	06-8372	25 mm
WALTER 06-8373 - 06-8374 gouges for taking grafts from the ribs 205 mm	06-8373	10 mm
	06-8374	15 mm
STILLE 06-8375 - 06-8380 Osteotomes 205 mm	06-8375	8 mm
	06-8376	10 mm
	06-8377	12 mm
	06-8378	15 mm
	06-8379	20 mm
06-8380	25 mm	









STILLE
06-8381 - 06-8385
Osteotomes
205 mm

STILLE
06-8386 - 06-8390
Osteotomes, curved
205 mm

LAMBOTTE
06-8391 - 06-8402
Osteotomes
245 mm

LAMBOTTE
06-8403 - 06-8408
Osteotomes, curved
245 mm

 <p> 06-8409 4 mm 06-8410 6 mm 06-8411 8 mm 06-8412 10 mm 06-8413 12 mm </p> <p> LEXER-MINI 06-8409 - 06-8413 Osteotomes 180 mm </p>	 <p> 06-8414 4 mm 06-8415 6 mm 06-8416 8 mm 06-8417 10 mm 06-8418 12 mm </p> <p> LEXER-MINI 06-8414 - 06-8418 Gouges 180 mm </p>	 <p> 06-8419 5 mm 06-8420 7 mm 06-8421 10 mm 06-8422 15 mm 06-8423 20 mm 06-8424 25 mm 06-8425 30 mm </p> <p> LEXER 06-8419 - 06-8425 Gouges 220 mm </p>
 <p> 06-8426 5 mm 06-8427 7 mm 06-8428 10 mm 06-8429 15 mm 06-8430 20 mm 06-8431 25 mm 06-8432 30 mm </p> <p> LEXER 06-8426 - 06-8432 Osteotomes 220 mm </p>	 <p> 06-8433 9mm Gouge for removing broken screws 220 mm </p>	 <p> 06-8434 5,5 mm 06-8435 9,0 mm </p> <p> ZIELKE 06-8434 - 06-8435 Gouges for scoliosis-operations 230 mm </p>





06-8442
Reposition forceps,
for small fragments
135 mm



06-8443
HAASE
Reposition forceps,
for mandibular
fractures
165 mm



06-8444
REILL
Reposition forceps,
170 mm



06-8445
Reposition forceps
205 mm



06-8446
MEYER
Reposition forceps
for fingers, with drill
guide for KIRSCHNER
wires up to diam. 1.0 mm
170 mm



06-8447
Patella forceps
185 mm



06-8448
Forceps with
ratchet fixation
140 mm



06-8449
Forceps with
thread fixation
170 mm



06-8450
Forceps with
thread fixation
235 mm

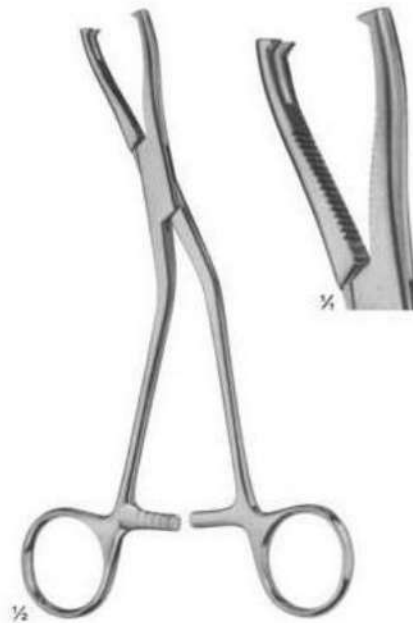

06-8451
DINGMANN modif
185 mm



06-8452
Sequestrum
forceps
200 mm



06-8453
VAN BUREN
Sequestrum
forceps
225 mm



06-8454
LANGENBECK
205 mm



06-8455
FERGUSSON
205 mm

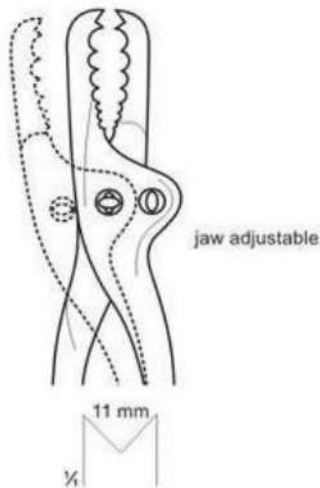

06-8456
SEMB
190 mm



06-8457
FARABEU
230 mm



06-8458
FARABEU
255 mm



06-8459
FARABEU-LAMBOTTE
255 mm





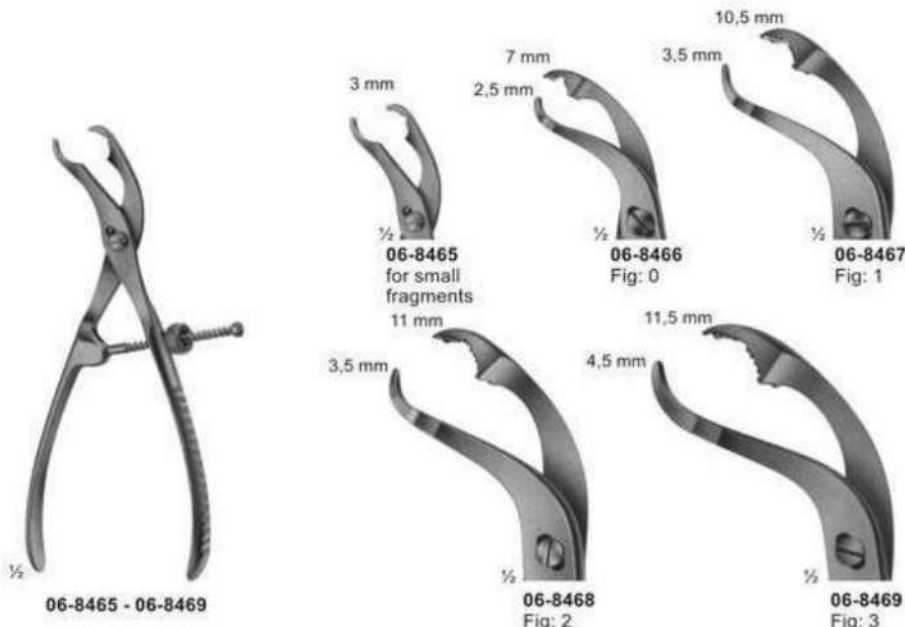

- 06-8465 145 mm
- 06-8466 190 mm
- 06-8467 240 mm
- 06-8468 260 mm
- 06-8469 280 mm

Self-centering forceps with thread fixation

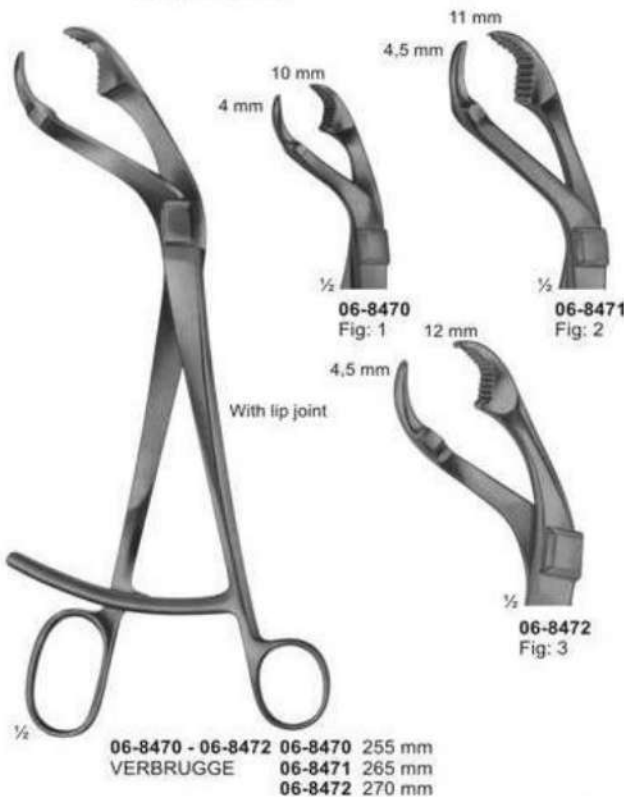

- 06-8470 255 mm
- 06-8471 265 mm
- 06-8472 270 mm





06-8474 - 06-8475
LOWMAN
06-8474 170 mm
06-8475 205 mm



06-8476
LOWMAN-GERSTER
210 mm



06-8477
LOWMAN-HOGLUND
175 mm

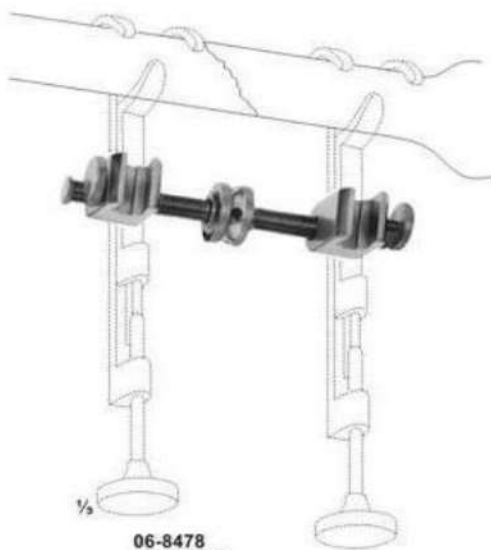

06-8478
GERSTER
Traction bar for 06-8474 - 06-8477



06-8479 - 06-8480
Synovectomy rongeur
width of jaws 1.2 mm
130 mm



06-8481 - 06-8482
Synovectomy rongeur
width of jaws 2.0 mm
130 mm



06-8483
STELLBRINK
Synovectomy rongeur
175 mm



06-8484
STELLBRINK
Synovectomy rongeur
170 mm



06-8485
LUER-FRIEDMANN
145 mm



06-8486
140 mm



06-8487
LUER
150 mm



06-8488
LUER
155 mm



06-8489
BLUMENTHAL
155 mm



06-8490
BLUMENTHAL
150 mm



06-8491 - 06-8492
JANSEN
175 mm



06-8493
BANE-HARTMANN
175 mm



06-8494
ALEXANDER
140 mm



06-8495
JANSEN
190 mm

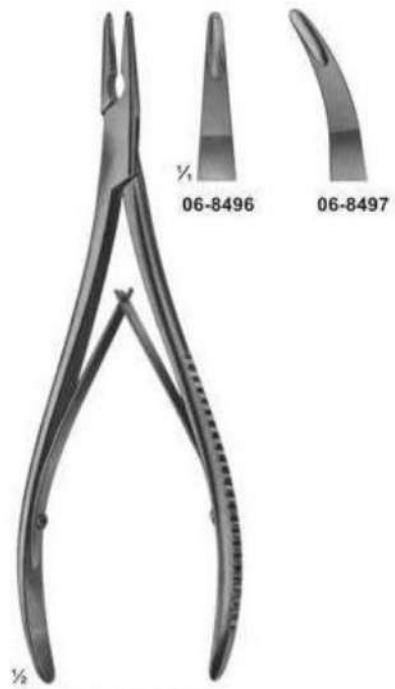

06-8496 - 06-8497
LEMPERT
200 mm

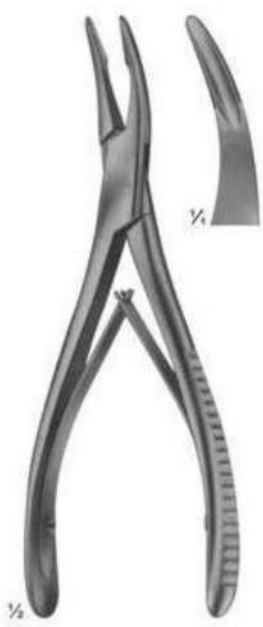

06-8498
BEYER
180 mm



06-8499
MEAD
165 mm



06-8500
MEAD
165 mm

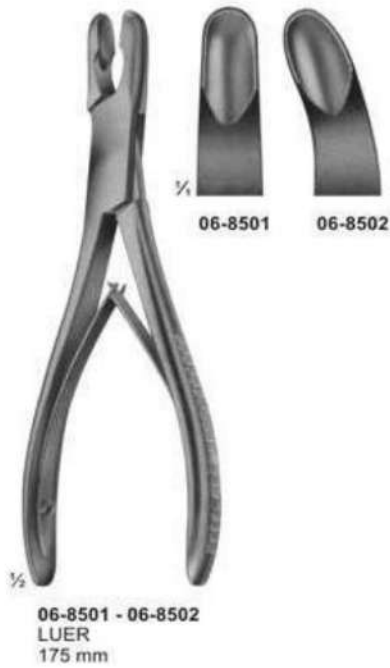



06-8509
RUSKIN
190 mm



06-8510
ROETTGEN-RUSKIN
240 mm



06-8511 - 06-8512
ECHLIN
230 mm



06-8513
STILLE
235 mm



06-8514
LEKSELL-STILLE
240mm



06-8515
STILLE-RUSKIN
240mm



06-8516
LUER-STILLE
225 mm



06-8517
LUER-STILLE
225 mm



06-8518
LUER-STILLE
270 mm



06-8519
SEMB
240 mm



06-8520
STAMM
150 mm



06-8521
KAZANJIAN
185 mm



06-8522 - 06-8525
LISTON



06-8522
140 mm



06-8523
170 mm



06-8525
220 mm



06-8526 - 06-8528
LISTON



06-8526
170 mm

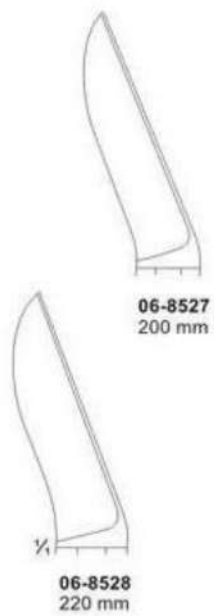

06-8527
200 mm

06-8528
220 mm



06-8529
BOEHLER
145 mm



06-8530
RUSKIN-LISTON
190 mm



06-8531
RUSKIN-LISTON
190 mm



06-8532
LISTON
curved on flat
240 mm

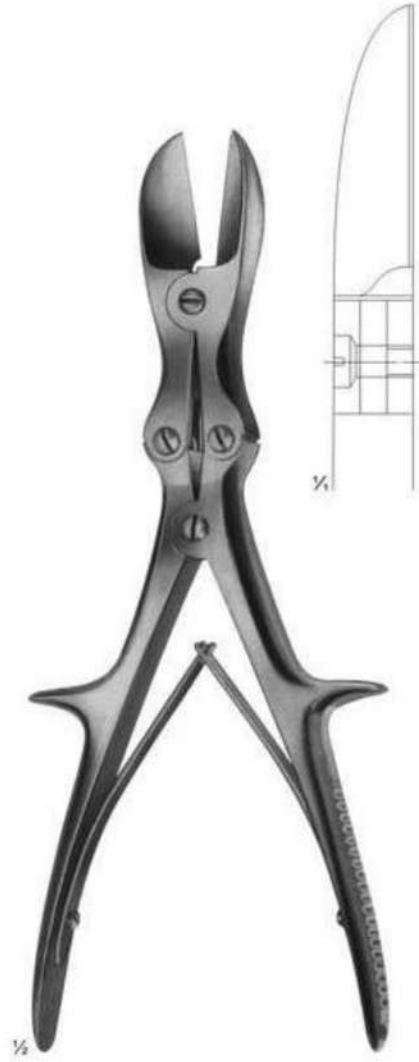

06-8533
LISTON
straight
280 mm

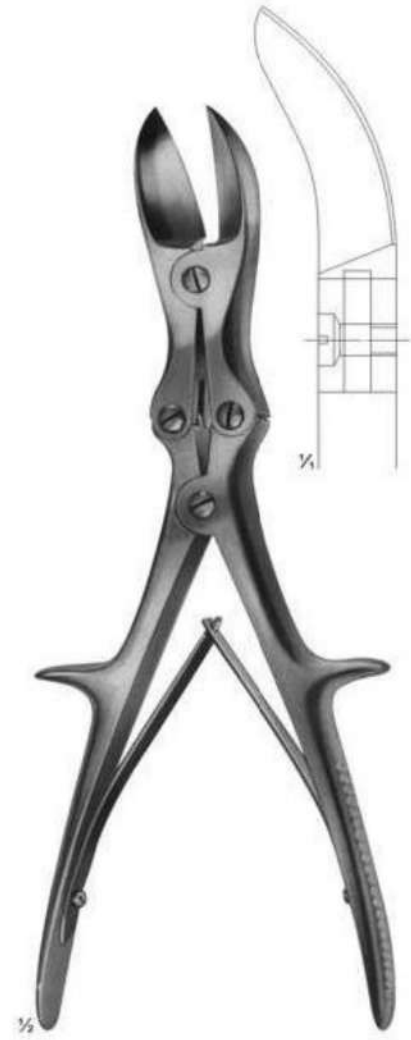

06-8534
LISTON
curved on flat
280 mm

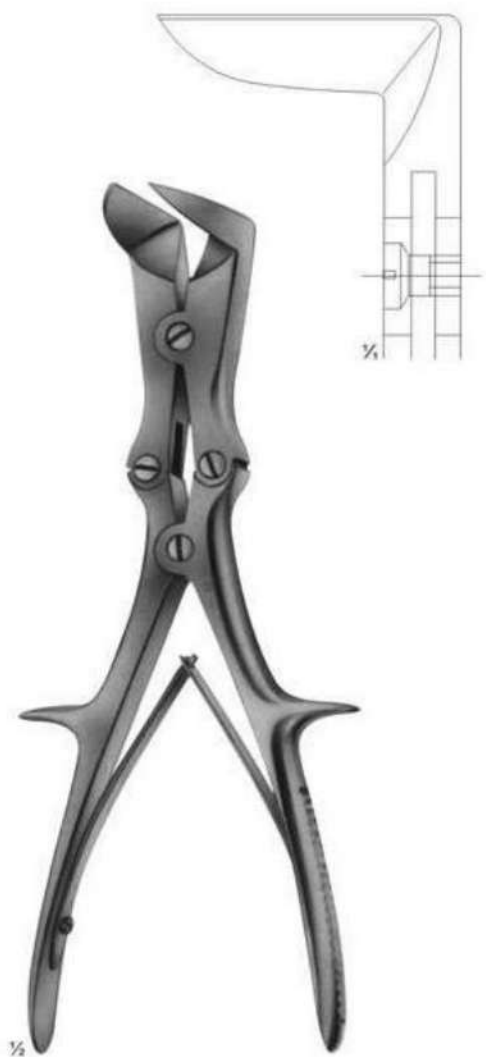

06-8535
LISTON-STILLE
265 mm

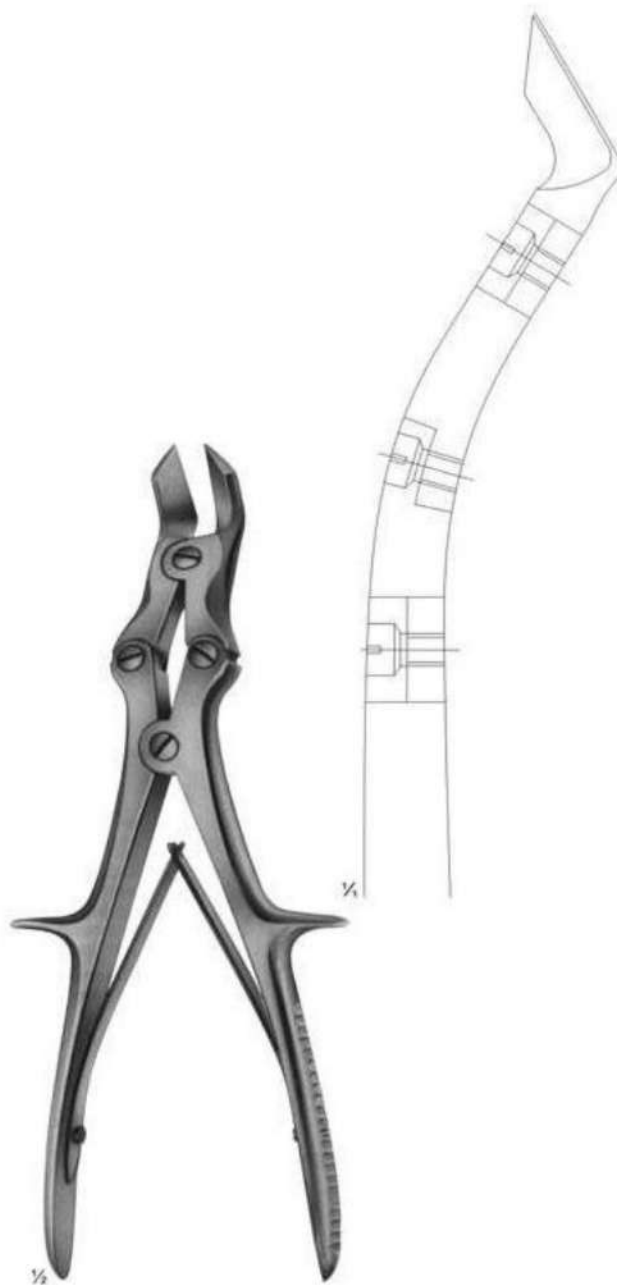

06-8536
LISTON-KEY-HORSLEY
(TUDOR EDWARDS)
255 mm





1/2
06-8543
170 mm



1/2
06-8544
NEFF
215 mm



1/2
06-8545
NEFF
215 mm



1/2
06-8546
WAGNER
215 mm

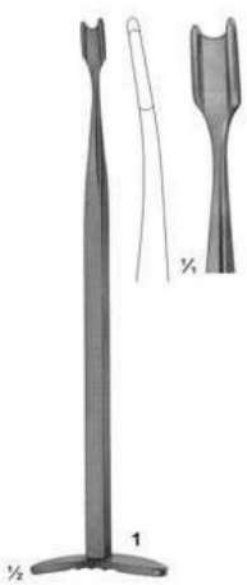

06-8547 SMILLIE 170 mm

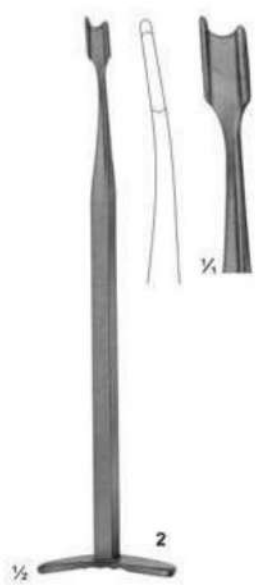

06-8548 SMILLIE 170 mm

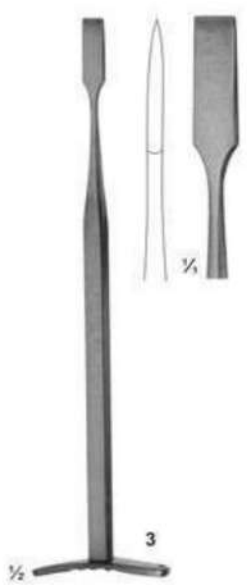

06-8549 SMILLIE 170 mm

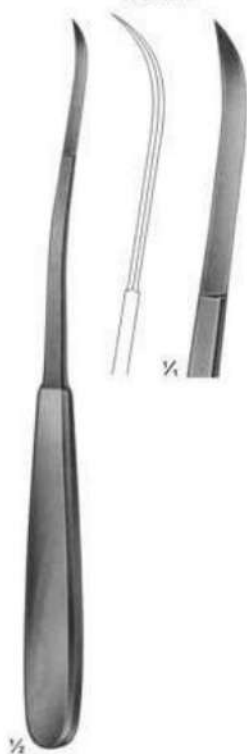

06-8550 SALENIUS 220 mm



06-8551 SALENIUS 220 mm



06-8552 CANAD. MODELL 200 mm



06-8553 CANAD. MODELL 200 mm

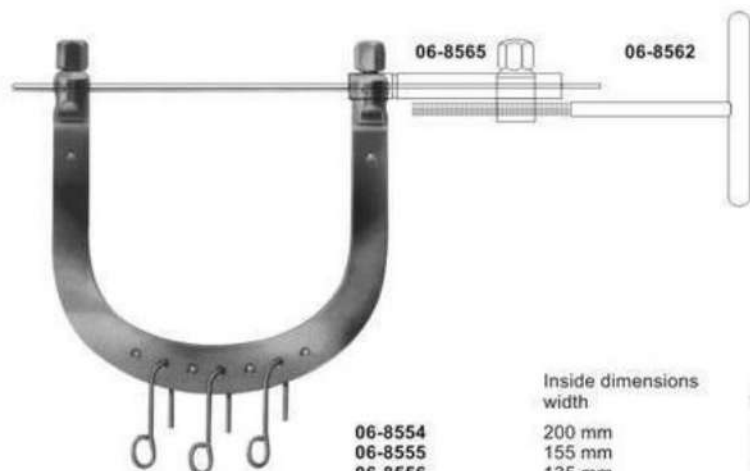

06-8554 - 06-8560
KIRSCHNER
 Wire traction bows,
 to be used with
 KIRSCHNER-wires
 up to 2.5 mm diam.,
 With 3 hooks,
 stainless steel

- 06-8554**
- 06-8555**
- 06-8556**
- 06-8557**
- 06-8558**
- 06-8559**
- 06-8560**

Inside dimensions	width	depth
	200 mm	155 mm
	155 mm	155 mm
	135 mm	130 mm
	120 mm	120 mm
	105 mm	100 mm
	95 mm	110 mm
	95 mm	70 mm

- for the hip
- for the femur
- for the knee
- for the knee
- for the knee
- for the calcaneus
- for the arm and elbow



06-8561
 Wrench, double - ended,
 for wire traction bows



06-8562
 Wire tightener, with
 clamping jaws



06-8563
 Traction hook only,
 large size



06-8564
 Traction hook only,
 small size



06-8565
 Fixation clamp, to secure clamping
 jaws of **06-8562** stainless steel

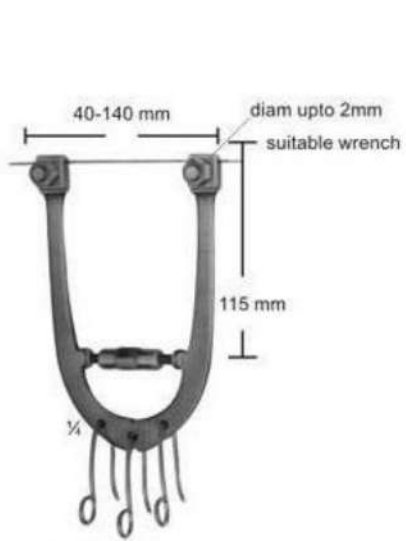

06-8566
Wire traction bow, adjustable, with 3 hooks, small size

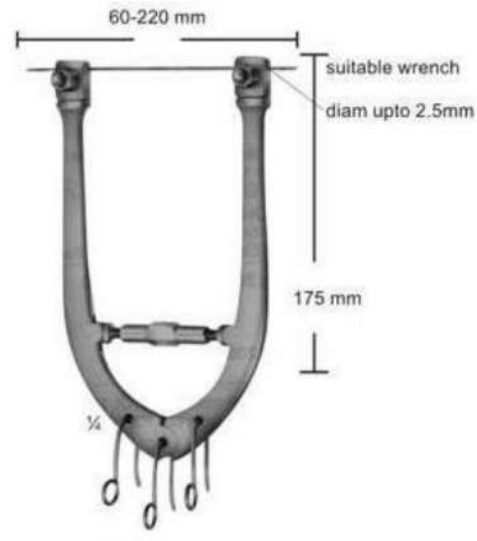

06-8567
Wire traction bow, adjustable, with 3 hooks, large size

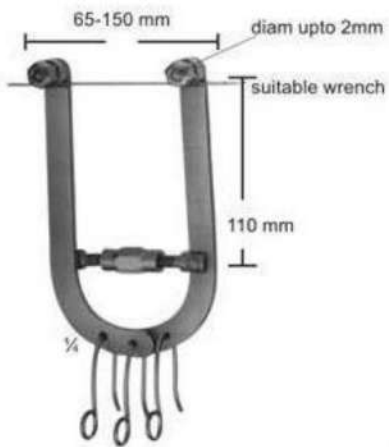

06-8568
Wire traction bow, adjustable, with 3 hooks, small size for elbow and calcaneus, for adolescents



06-8569	max. 105 mm
06-8570	max. 160 mm
06-8571	max. 200 mm
06-8569	80-95 mm
06-8570	90-120 mm
06-8571	140-170 mm
diam upto	
06-8569	1,6 mm
06-8570	2,0 mm
06-8571	2,5 mm

06-8569 - 06-8571
KIRSCHNER
Wire traction bows, modified, adjustable in width, holds wire securely, with 1 hook



06-8572
Fixation disc, slotted



06-8574
Fixation disc, slotted



06-8573
idem, aluminum, transparent to X-rays



06-8575
Screw driver, for above fixations discs



Boehler traction bows, to be used with STEINMANN pins, 4mm diam	Boehler traction bows, to be used with STEINMANN pins, 5mm diam	Inside width	For
06-8576 with pin (09-8588)		16x9cm	Arm
06-8577 without pin	06-8582 without pin		
06-8578 with pin (09-8590)		21x11cm	Femur and knee
06-8579 without pin	06-8583 without pin		
06-8580 with pin (09-8592)		21x15cm	Femur and knee
06-8581 without pin			



06-8584 - 06-8598
STEINMANN
triangular shaft ended and trocar point

diam \varnothing	4,0 mm	5,0 mm
Length		
80 mm	06-8584	
100 mm	06-8585	
120 mm	06-8586	
140 mm	06-8587	
150 mm	06-8588	06-8594
160 mm	06-8589	
180 mm	06-8590	06-8595
200 mm	06-8591	06-8596
210 mm	06-8592	
250 mm	06-8593	06-8597
300 mm		06-8598



06-8599
SCHWARZ
Traction bow for fingers,
to be used with KIRSCHNER-
wire up to 1.6 mm diam.



06-8600
Small distractor
as a repositioning device for
distraction and compression of small bones,
for wires with 3.0 mm diam.



06-8601
Protection cap
for 4,0 mm STEINMANN Pins



06-8602
Protection cap
for 5,0 mm STEINMANN Pins



06-8603
REILL
Drilling chuck, cannulated, for shanks from 2.0 - 2.5 mm diam 115 mm



06-8604
Drilling chuck, cannulated, for shanks from 0.8 - 2.0 mm diam 150 mm



06-8605
Drilling chuck, cannulated, for shanks up to 4.5 mm diam with key 140 mm

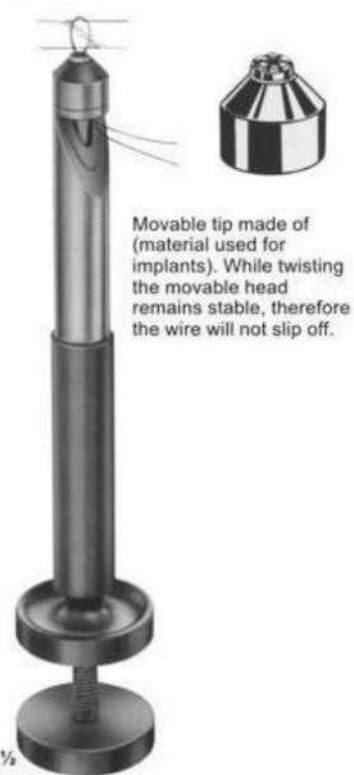

Movable tip made of (material used for implants). While twisting the movable head remains stable, therefore the wire will not slip off.

06-8606
LOUTE
Wire tightener, improved pattern, with movable tip, for wires up to 1.0 mm diam. 220 mm

Chuck jaws made of material used for implants



06-8607
Drilling chuck, cannulated, for shanks up to 6.35 mm diam., To be tightened by hand 100 mm



06-8608
Drilling chuck, cannulated, for shanks up to 4.5 mm diam., And for triangular shaft width across flats 4.7 mm (schanz screws, steinmann pins). with key **06-8609**



06-8610
Drilling chuck, cannulated, for shanks up to 6.35 mm diam., With key (**06-8611**) 160 mm

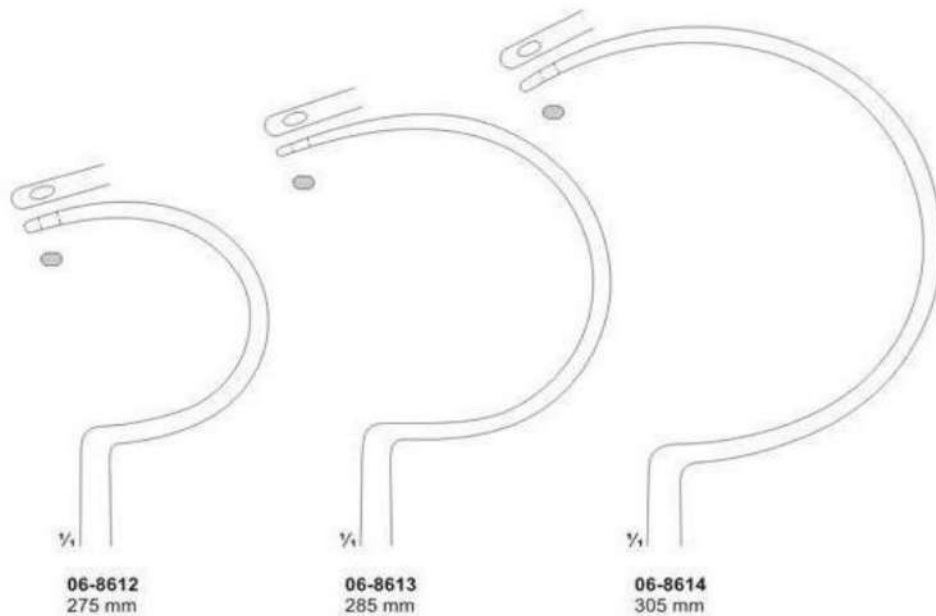

06-8612 - 06-8614
DEMEL
Wire guides



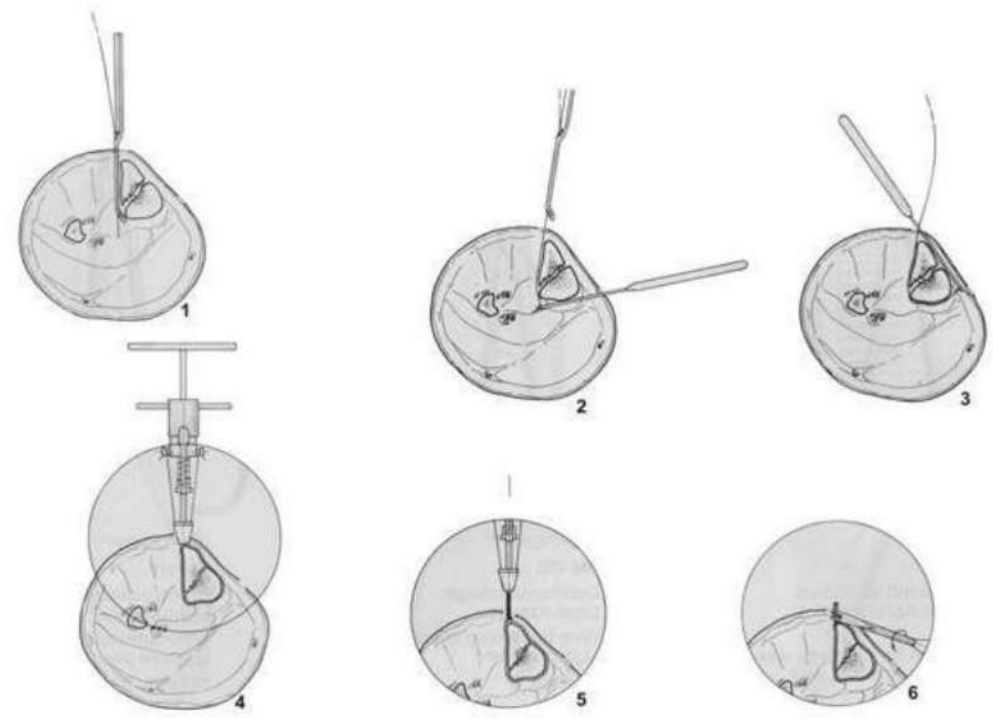

06-8618
JORDAN
Wire tightener



06-8619
JORDAN
Wire twister
170 mm



06-8620
JORDAN
Wire catcher
180 mm



06-8621
JORDAN
Probe, cannulated
170 mm



06-8622
DUROGRIP
Holding forceps for cerclage wire, with lateral jaws to avoid wire slipping off
170 mm



06-8623
DUROGRIP
Wire, tightening pliers, Ligature pliers
150 mm



06-8624
DUROGRIP
Wire, tightening pliers, Ligature pliers
150 mm



06-8625
with serrated jaws
140 mm



06-8626
one jaw smooth, one jaw serrated
140 mm



06-8627
with serrated jaws
06-8628
with longitudinal and transversal grooves
170 mm



06-8629
190 mm



06-8630
130 mm

06-8631
180 mm



06-8630 - 06-8631
Extraction pliers
for boring wires



06-8632
Flat-nosed pliers,
parallel
185 mm

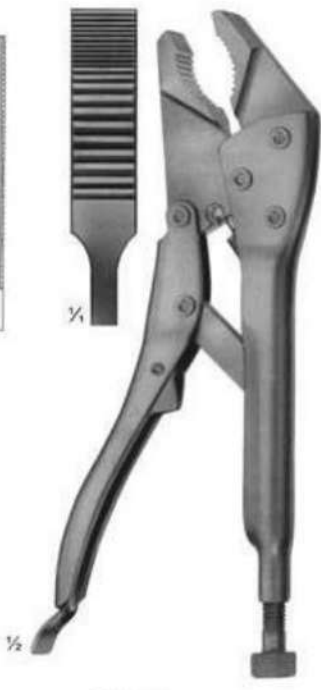

06-8633
Vise grip
200 mm

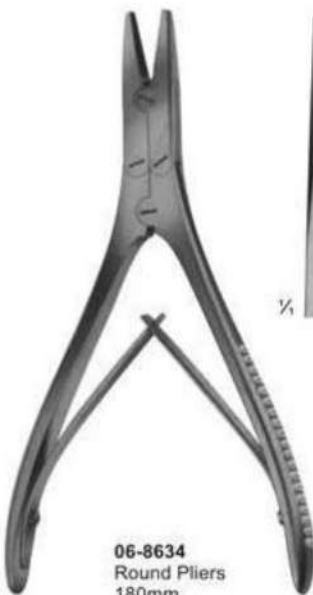

06-8634
Round Pliers
180mm



06-8634 - 06-8637

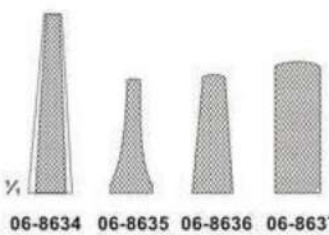

06-8635 145 mm
06-8636 180 mm
06-8637 180 mm
Extraction pliers for wires



06-8638
Bending pliers
for wires up to
1.8 mm diam.



06-8639 ANGLE
130 mm
06-8640 DUROTIP ANGLE
130 mm

for soft wire
up to diam.
for hard wire
up to diam.

0,5 mm 0,6 mm
0,3 mm 0,4 mm

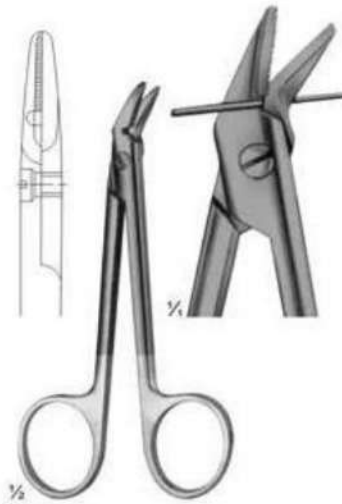

06-8641 120 mm
06-8642 DUROTIP 120 mm

for soft wire
up to diam.
for hard wire
up to diam.

1,2 mm 1,2 mm
0,8 mm 0,8 mm

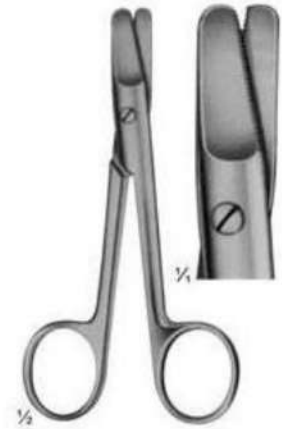

06-8643
HARVEY
125 mm

0,4 mm
0,3 mm



06-8644
150 mm

for soft wire
up to diam.
for hard wire
up to diam

1,5 mm
1,0 mm



06-8645
160 mm

1,5 mm
1,2 mm



06-8646
140 mm
DUROTIP
1,5 mm

1,0 mm



06-8647
180 mm

for soft wire up to diam. 2,0 mm
For hard wire up to diam 1,5 mm
specially hardened cutting edges, front and lateral cutting action

06-8648
REILL
175 mm

for soft wire up to diam. 2,0 mm
For hard wire up to diam 1,6 mm
specially hardened cutting edges, for cutting off wires close to the bone

DUROTIP

06-8649
235 mm

for soft wire up to diam. 3,0 mm
For hard wire up to diam 2,2 mm

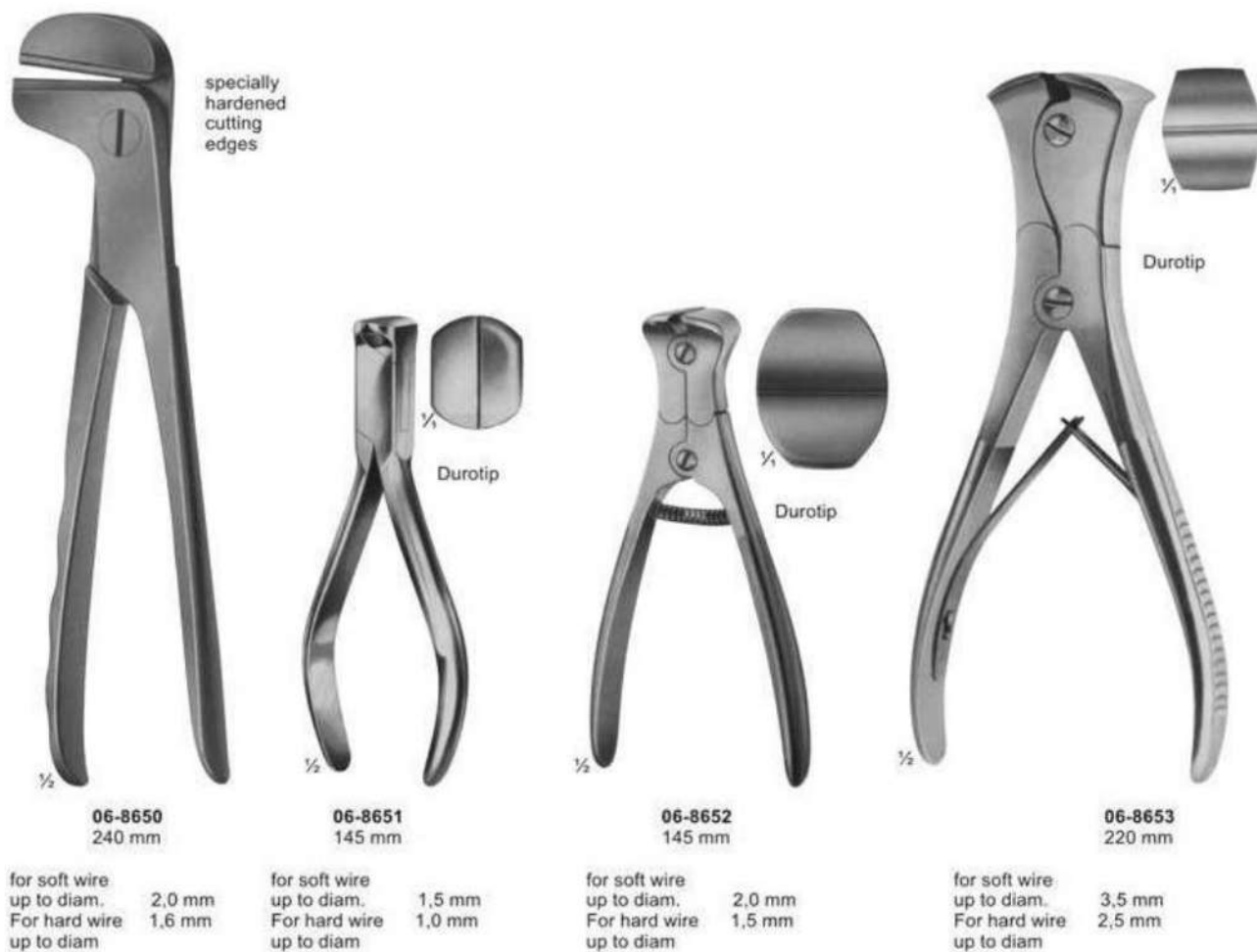



06-8654
320 mm

for soft wire
up to diam. 3,0 mm
For hard wire
up to diam 3,0 mm



Cutter for cutting off
KIRSCHNER wires,
Tibia head screws,
bolts, pins, up to 3 mm diam.



DUROTIP

06-8655
Cutter for cutting off
KIRSCHNER wires,
Tibia head screws,
bolts, pins, up to 6 mm diam.
470 mm



06-8656
Nail extracting
forceps
135 mm



06-8657
Nail extracting
forceps
145 mm



06-8658
Finger nail drill
with 3 drill points

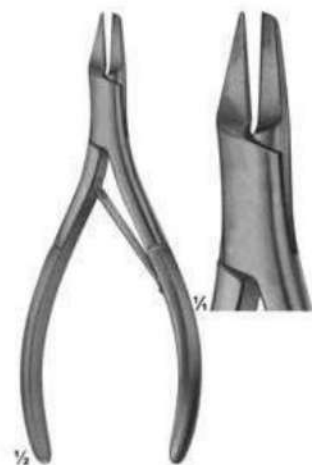

06-8662
Nail splitting
forceps
135 mm



06-8663
SYSTRUNK
Scissors, for splitting
finger nails
130 mm



06-8664
Finger ring saw
150 mm

Spare blade
06-8665

Plaster Knives



with ebony handle

07-9001
HOPKINS
200 mm



07-9002
ESMARCH
180 mm

Plaster Saw



07-9003
ENGEL
160 mm

Bandage and First-Aid scissors



07-9004 - 07-9012 145mm

07-9004	black	07-9008	yellow
07-9005	red	07-9009	white
07-9006	blue	07-9010	orange
07-9007	light green	07-9011	voilet
		07-9012	bright pink



07-9013 - 07-9021 180mm

07-9013	black	07-9017	yellow
07-9014	red	07-9018	white
07-9015	blue	07-9019	orange
07-9016	light green	07-9020	voilet
		07-9021	bright pink

For small plaster dressings



Special features:
The construction of the open jaws avoids tiresome clogging by plaster remnants and allows furthermore an easy cleaning.
The shears do not glide off the plaster owing to the deep teething on the jaws.
The knives with hollow grinding have a better cutting ability and therefore less force is required.
The knives are guided by ball bearings.



07-9029
STILLE
260 mm



07-9030
STILLE
360 mm

Blade with reinforced back



07-9032
STILLE
230 mm

07-9033
Spare blade



07-9034
STILLE
370 mm

07-9035
Spare blade



07-9036
STILLE
240 mm

07-9037
Spare blade

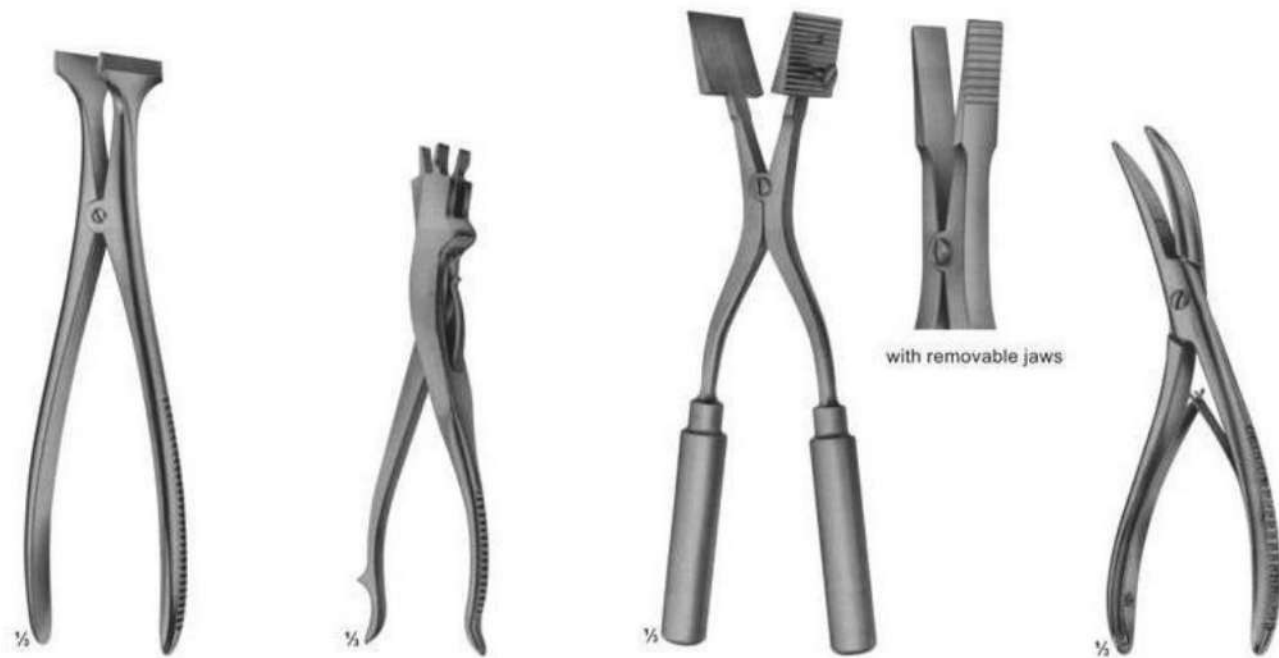

07-9038
HENNIG
270 mm

07-9039
MOD. USA
230 mm

07-9040
290 mm

07-9041 - 07-9042
WOLFF
07-9041 180 mm
07-9042 240 mm
plaster breakers

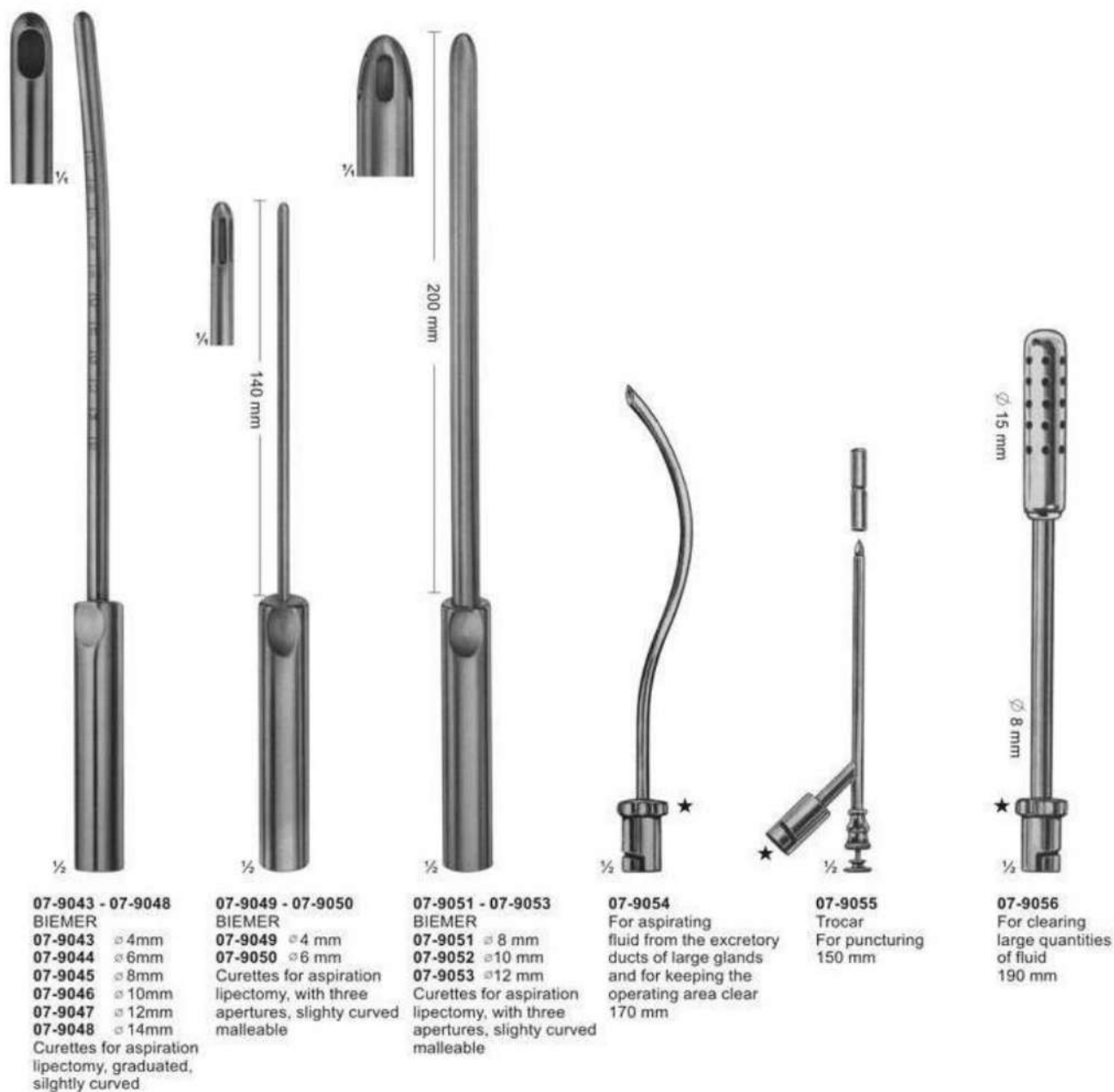

07-9057 150mm
Suction handle, with vacuum regulator and finger cut-off, brass, mirror-finish chromium-plated



olive
Ø 9 mm

07-9058 170mm
Suction handle, with hand regulation valve and quick-shutter, brass, mirror-finish chromium-plated



★ Both suction handles have bayonet fitting olive and can be used for the suction cannulae. Ø 9 mm



07-9059
Trocar
For puncturing
170 mm



★ **07-9060**
Hollow needle, sharp
150 mm



★ **07-9061**
double curved
For general surgery
230 mm



★ **07-9062**
For tonsillectomy, oral and laryngeal operations
190 mm



★ **07-9063**
For tonsillectomy, oral and laryngeal operations
220 mm

★ With bayonet fitting to be used with suction handles (07-9057 - 07-9058)

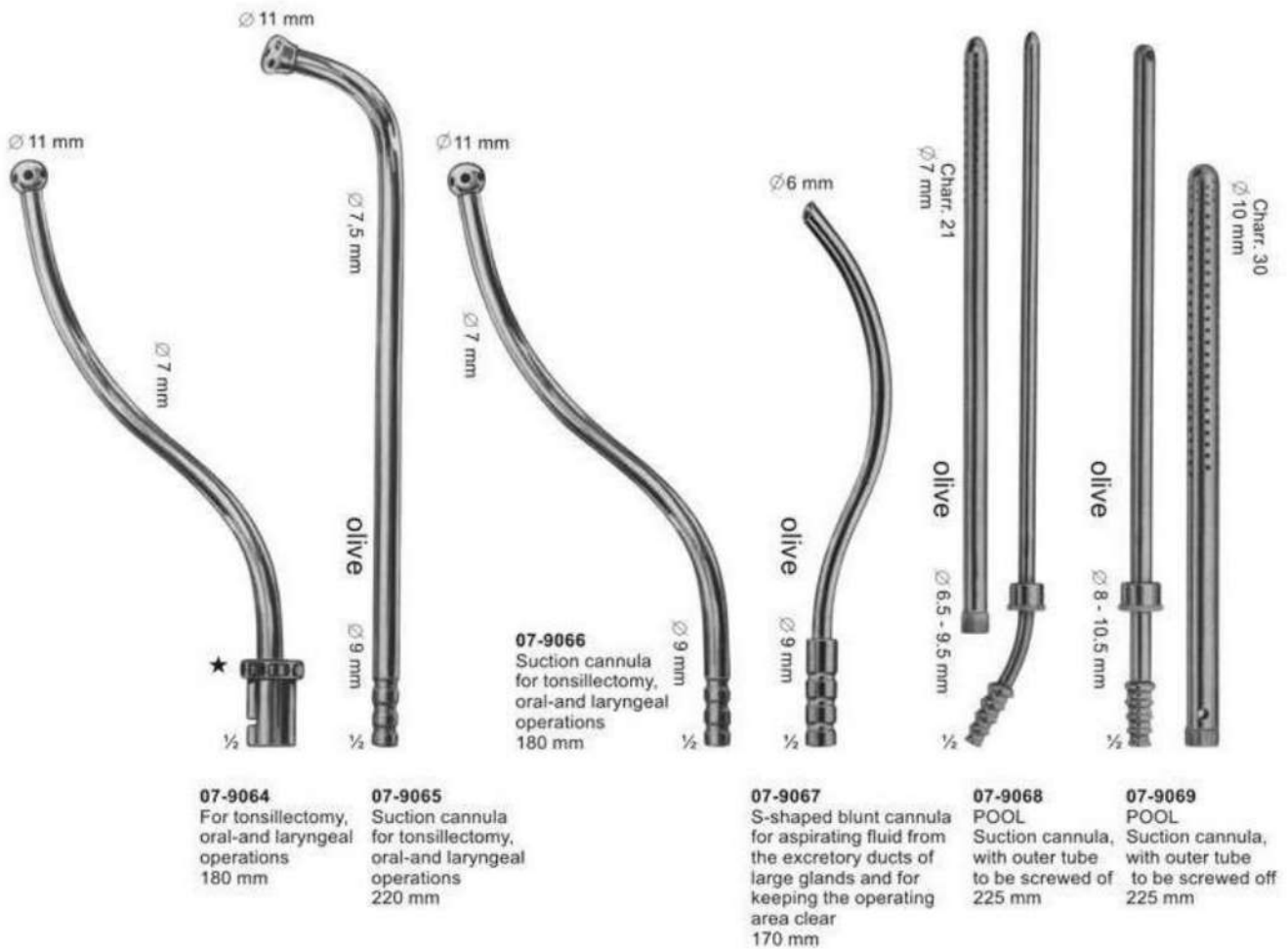

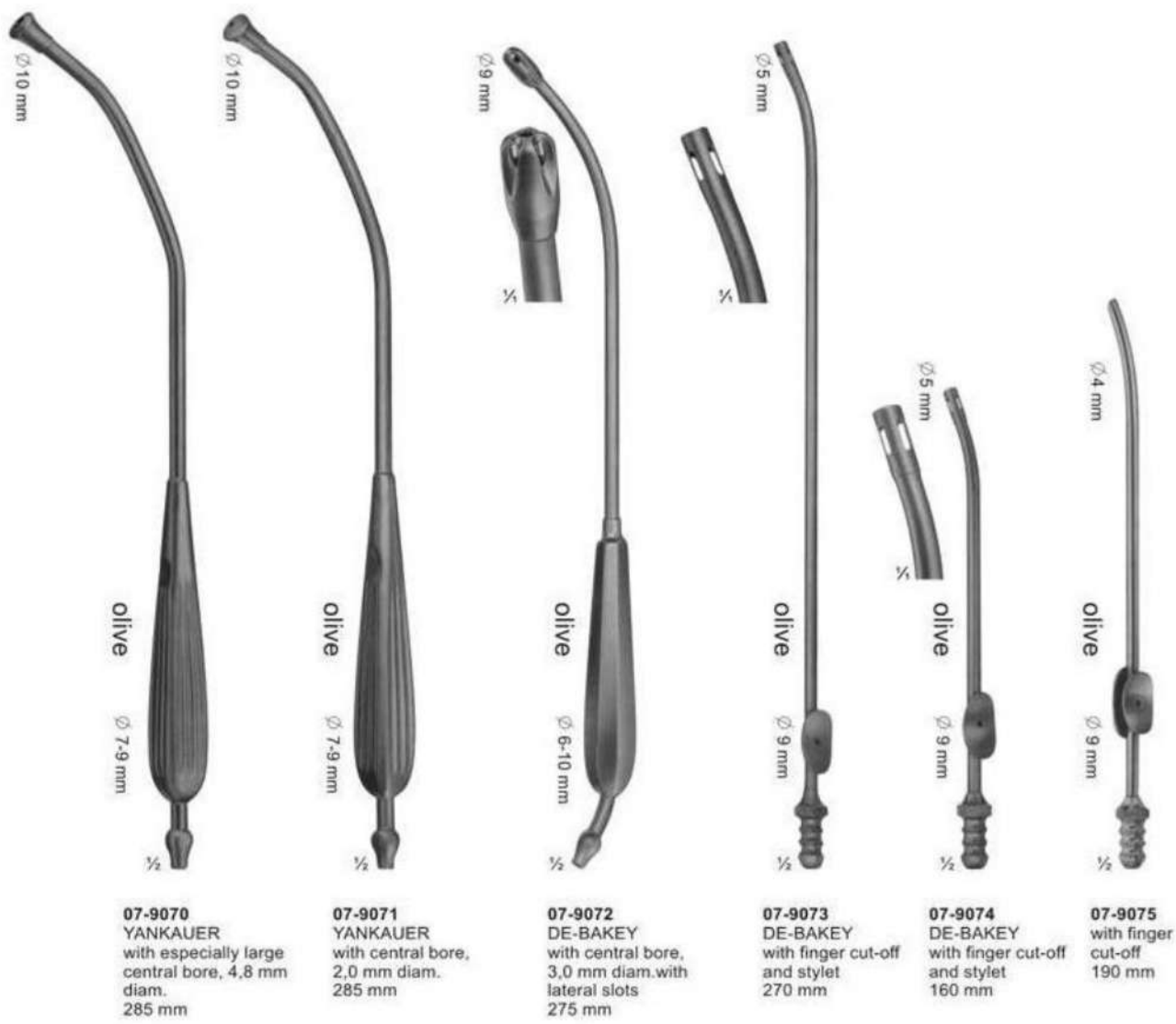

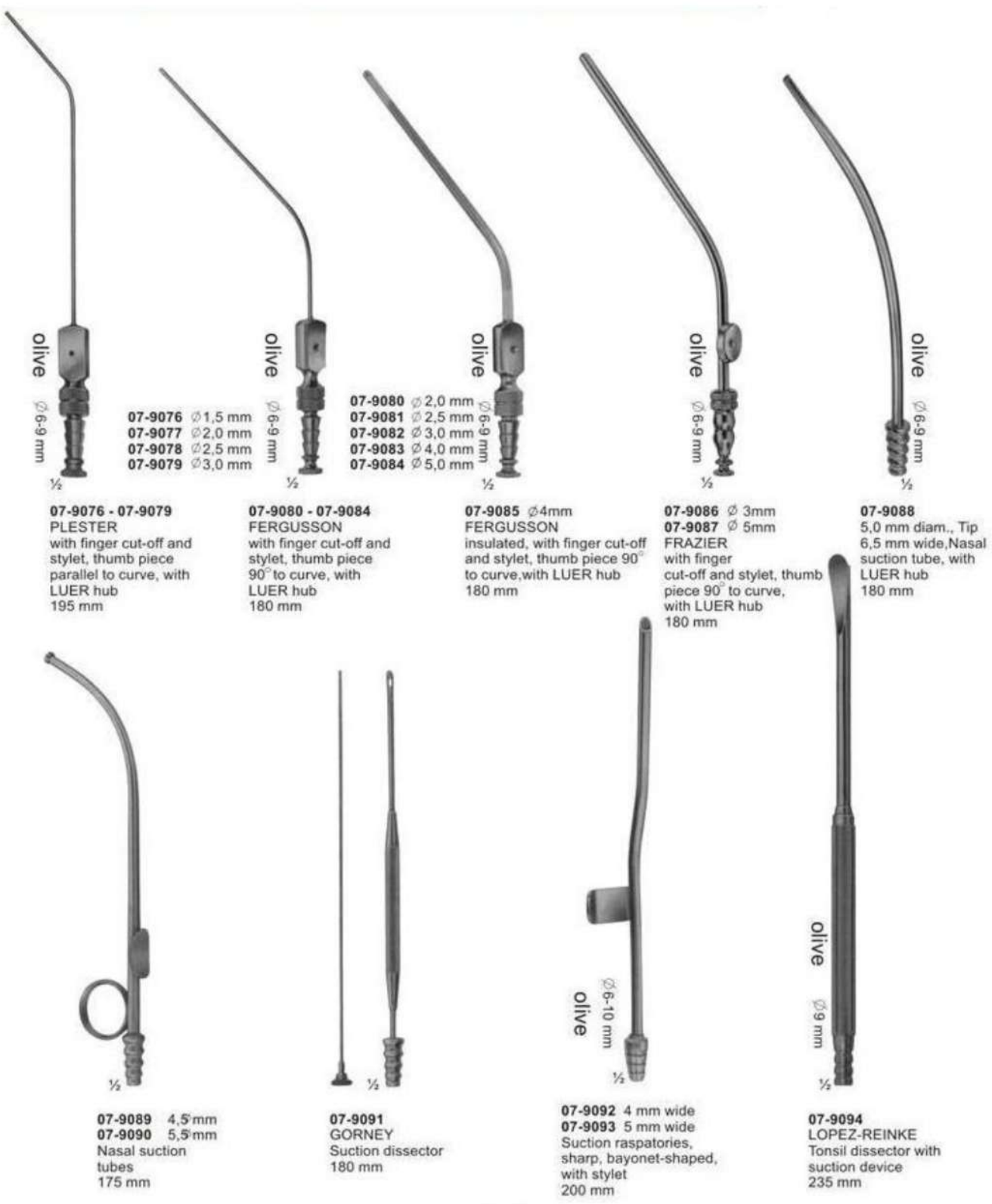

olive
∅ 6-9 mm
½

- 07-9076 ∅ 1,5 mm
- 07-9077 ∅ 2,0 mm
- 07-9078 ∅ 2,5 mm
- 07-9079 ∅ 3,0 mm

07-9076 - 07-9079
PLESTER
with finger cut-off and
stylet, thumb piece
parallel to curve, with
LUER hub
195 mm

olive
∅ 6-9 mm
½

- 07-9080 ∅ 2,0 mm
- 07-9081 ∅ 2,5 mm
- 07-9082 ∅ 3,0 mm
- 07-9083 ∅ 4,0 mm
- 07-9084 ∅ 5,0 mm

07-9080 - 07-9084
FERGUSSON
with finger cut-off and
stylet, thumb piece
90° to curve, with
LUER hub
180 mm

olive
∅ 6-9 mm
½

07-9085 ∅ 4mm
FERGUSSON
insulated, with finger cut-off
and stylet, thumb piece 90°
to curve, with LUER hub
180 mm

olive
∅ 6-9 mm
½

07-9086 ∅ 3mm
07-9087 ∅ 5mm
FRAZIER
with finger
cut-off and stylet, thumb
piece 90° to curve,
with LUER hub
180 mm

olive
∅ 6-9 mm
½

07-9088
5,0 mm diam., Tip
6,5 mm wide, Nasal
suction tube, with
LUER hub
180 mm



07-9089 4,5mm
07-9090 5,5mm
Nasal suction
tubes
175 mm



07-9091
GORNEY
Suction dissector
180 mm



07-9092 4 mm wide
07-9093 5 mm wide
Suction raspatories,
sharp, bayonet-shaped,
with stylet
200 mm



07-9094
LOPEZ-REINKE
Tonsil dissector with
suction device
235 mm

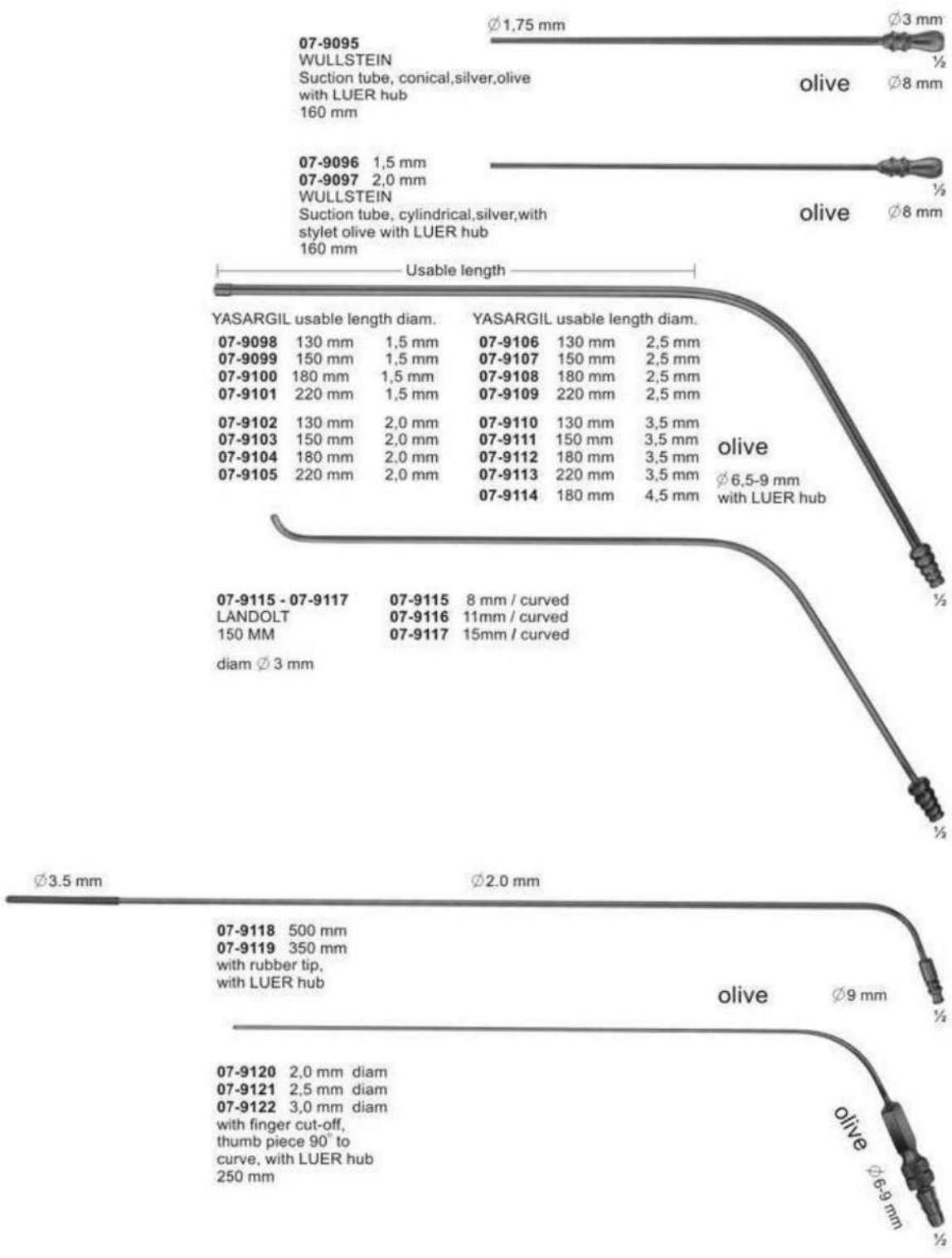

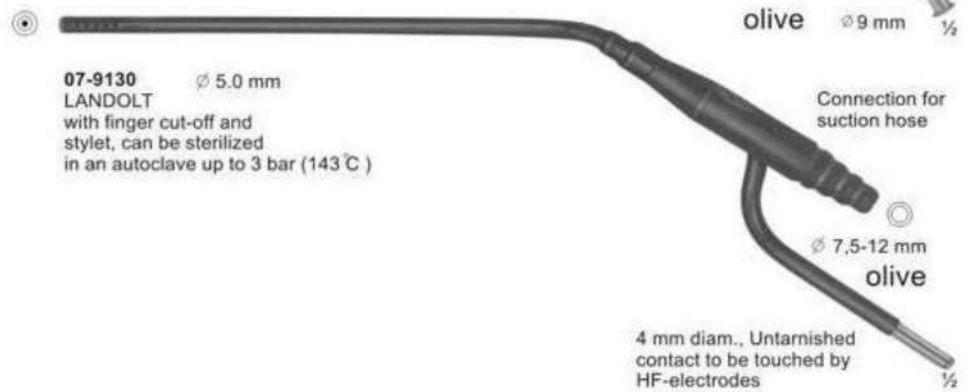
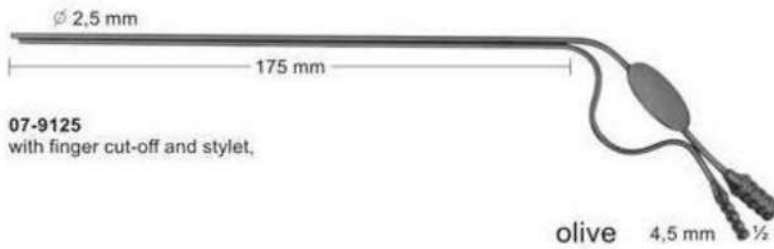

Scissors with Tungsten Carbide Inserts



07-9131 - 07-9133
STANDARD
07-9131 14,5cm
07-9132 16,5cm
07-9133 18,5cm



07-9134 - 07-9136
STANDARD
07-9134 14,5cm
07-9135 16,5cm
07-9136 18,5cm



07-9137 - 07-9139
STANDARD
07-9137 14,5cm
07-9138 16,5cm
07-9139 18,5cm



07-9140 - 07-9142
STANDARD
07-9140 14,5cm
07-9141 16,5cm
07-9142 18,5cm



07-9143 - 07-9145
STANDARD
07-9143 14,5cm
07-9144 16,5cm
07-9145 18,5cm



07-9146 - 07-9148
STANDARD
07-9146 14,5cm
07-9147 16,5cm
07-9148 18,5cm

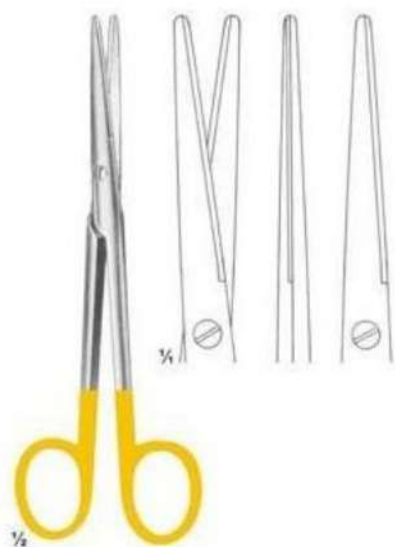

07-9149
MAYO-LEXER
16cm



07-9150
MAYO-LEXER
16cm

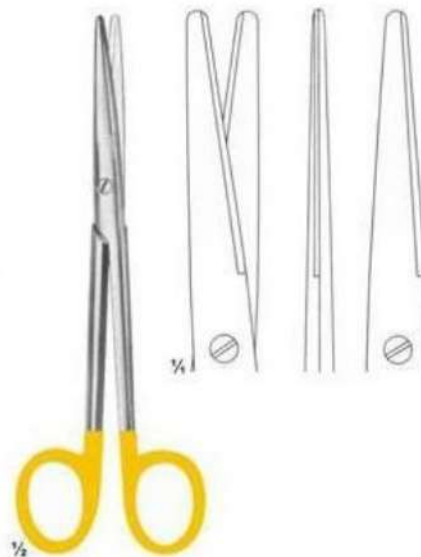

07-9151 - 07-9152
LEXER
07-9151 16cm
07-9152 21cm

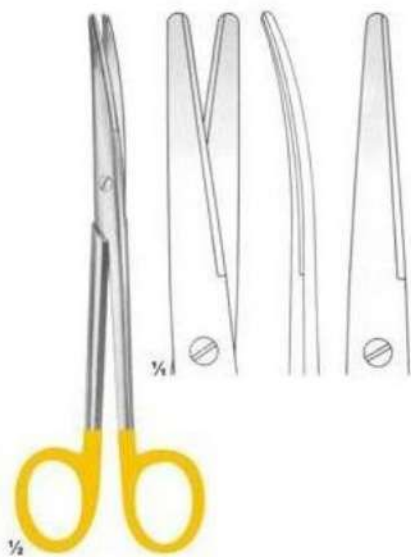

07-9153 - 07-9154
LEXER
07-9153 16cm
07-9154 21cm



07-9155 - 07-9156
MAYO-STILLE
07-9155 15cm
07-9156 17cm



07-9157 - 07-9158
MAYO-STILLE
07-9157 15cm
07-9158 17cm



07-9159 - 07-9160
METZENBAUM

- 07-9159 11.5cm
- 07-9160 14.5cm



07-9161 - 07-9164
METZENBAUM

- 07-9161 11.5cm
- 07-9162 14.5cm
- 07-9163 23cm
- 07-9164 25cm



07-9165 - 07-9170
METZENBAUM

- 07-9165 18cm
- 07-9166 20cm
- 07-9167 23.5cm
- 07-9168 25.5cm
- 07-9169 28cm
- 07-9170 30cm



07-9171 - 07-9176
METZENBAUM-FINO

- 07-9171 14cm
- 07-9172 18cm
- 07-9173 20cm
- 07-9174 23cm
- 07-9175 25cm
- 07-9176 28cm



07-9177 - 07-9182
METZENBAUM-FINO

- 07-9177 14cm
- 07-9178 18cm
- 07-9179 20cm
- 07-9180 23cm
- 07-9181 25cm
- 07-9182 28cm

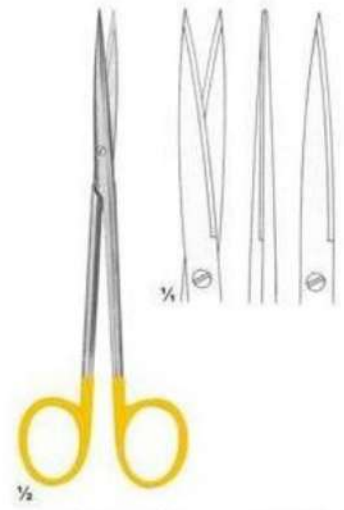

07-9183 - 07-9186
METZENBAUM-FINO

- 07-9183 14cm
- 07-9184 18cm
- 07-9185 20cm
- 07-9186 23cm

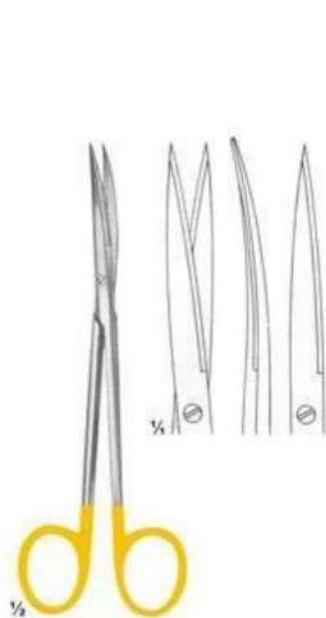

07-9187 - 07-9190
METZENBAUM-FINO

- 07-9187 14cm
- 07-9188 18cm
- 07-9189 20cm
- 07-9190 23cm

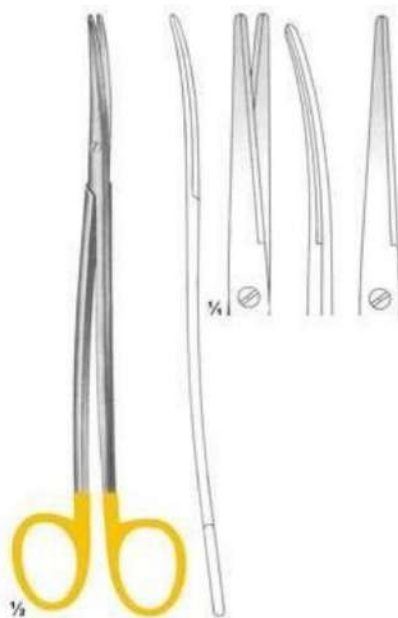

07-9191 - 07-9193
METZENBAUM-FINO

- 07-9191 18cm
- 07-9192 20cm
- 07-9193 23cm



07-9194 - 07-9196
METZENBAUM-FINO

- 07-9194 18cm
- 07-9195 20cm
- 07-9196 23cm

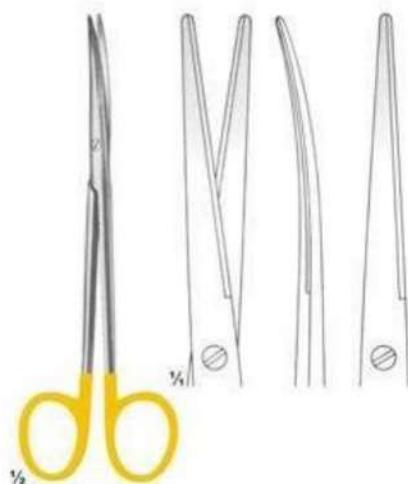

07-9197 - 07-9198
METZENBAUM

- 07-9197 20cm
- 07-9198 23cm

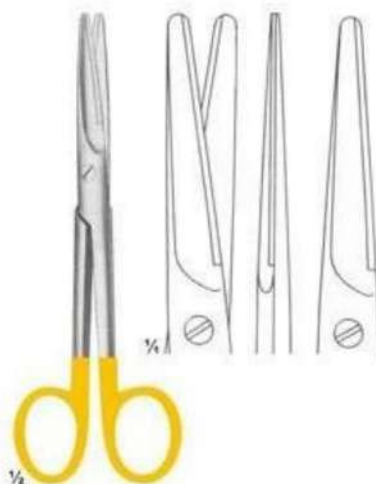

07-9199 - 07-9201
MAYO

- 07-9199 14.5cm
- 07-9200 17cm
- 07-9201 23cm

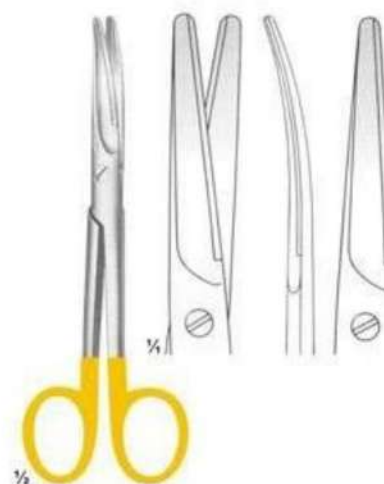

07-9202 - 07-9204
MAYO

- 07-9202 14.5cm
- 07-9203 17cm
- 07-9204 23cm

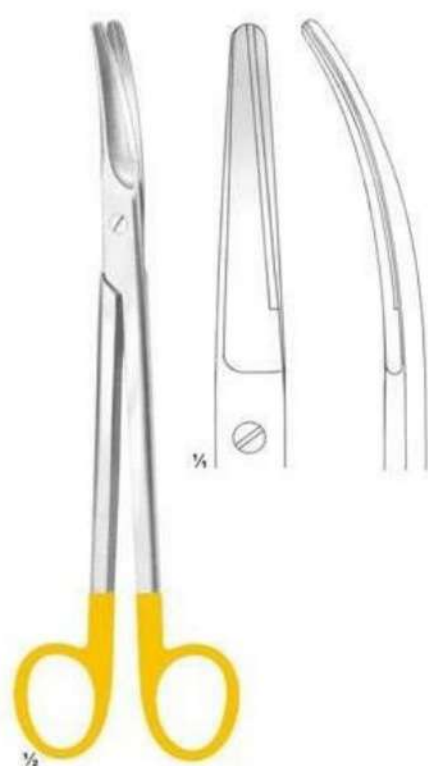

07-9205
WERTHEIM
Dissecting Scissors
23cm

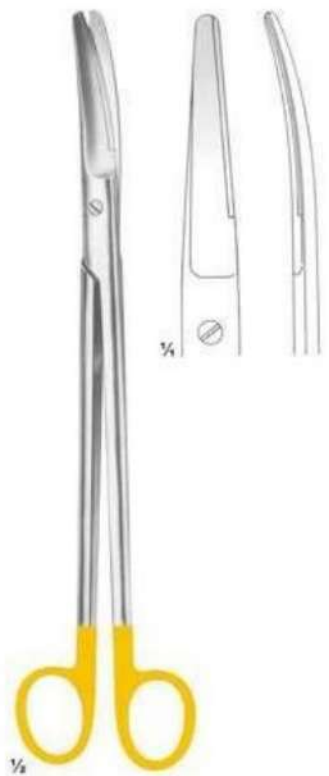

07-9206
SIMS
20cm
07-9207
23cm

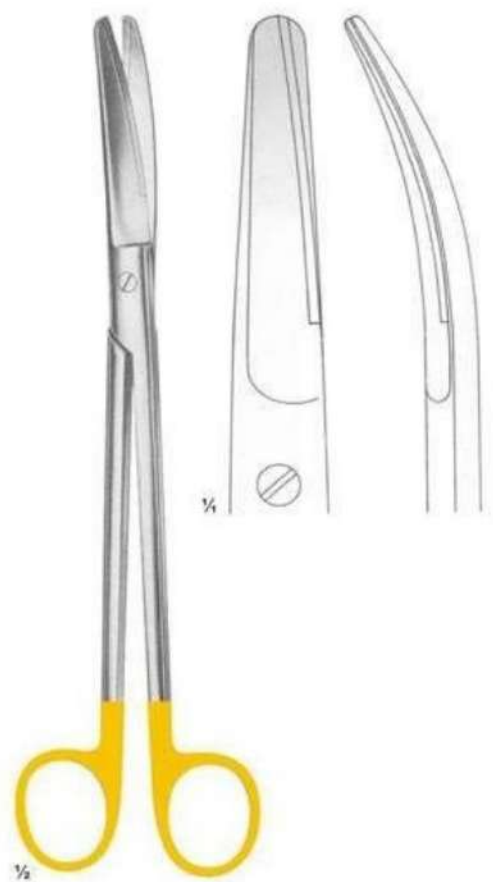

07-9208
MAYO-HARRINGTON
28cm



07-9209 - 07-9211
DE-BAKEY
(Potts-Smith)

07-9209	23cm	25
07-9210	23cm	45
07-9211	23cm	60



07-9212 - 07-9214
DE-BAKEY
(Potts-Smith)

07-9212	19cm	25
07-9213	19cm	45
07-9214	19cm	60

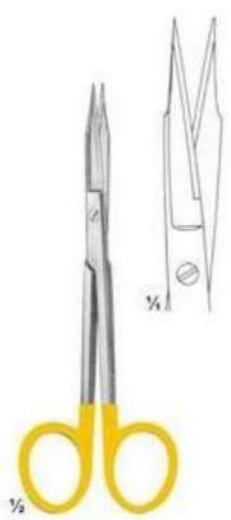

07-9215
GOLDMANN FOX
13cm



07-9216
GOLDMANN FOX
13cm

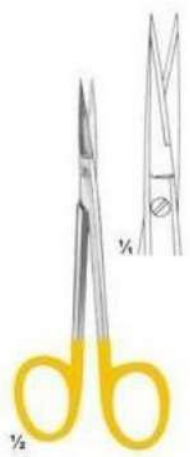

07-9217
Fine Scissor
11,5cm



07-9218
Fine Scissor
11,5cm

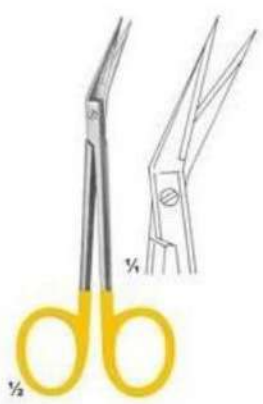

07-9219
11,5cm



07-9220
RAGNELL (Kilner)
12cm

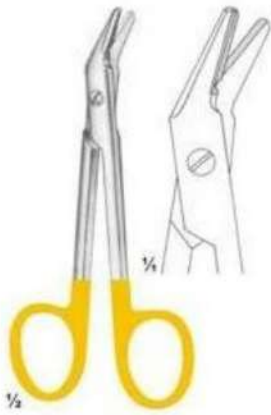

07-9221
UNIVERSAL
12cm



07-9222 - 07-9224
SUTURE SCISSORS
1 Black & 1 Gold Plated ring

07-9222 14cm
07-9223 17cm
07-9224 23cm



07-9225 - 07-9226
ADSON

07-9225 12cm
07-9226 15cm



07-9227
CUSHING
With dissector
end
17,5cm



07-9228
CUSHING
With dissector
end
18cm



07-9229
CUSHING-TAYLOR
18cm



07-9230
DISSECTING FORCEPS
15cm



07-9231
SEMKEN
15cm



1/2 1/4
07-9232 - 07-9234
WANGENSTEIN

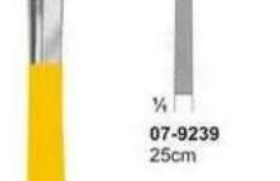
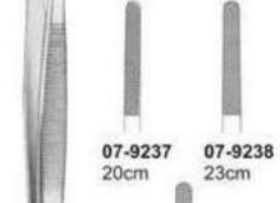
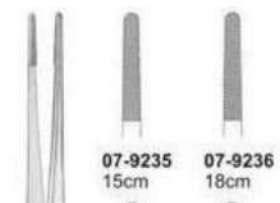

1/2
07-9235 - 07-9239
POTTS-SMITH

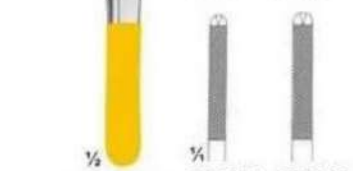
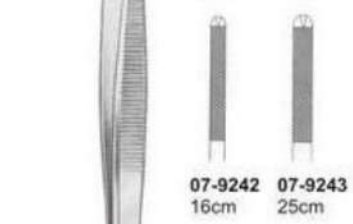
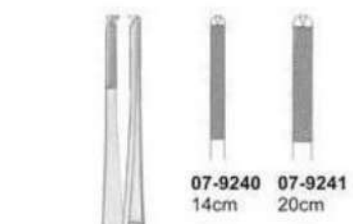

1/2 1/4 1/4
07-9240 - 07-9245
OEHLER



1/4
07-9246
POTTS-SMITH
22cm



1/2
07-9247
HEPP-SCHIEDEL
18cm



1/2
07-9248
CASTROVIEJO
14cm









1/2
07-9249
CASTROVIEJO
14cm

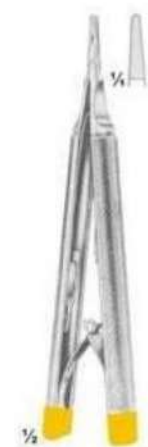

1/2
07-9250
ARRUGA
16cm

Needle Holders with Tungsten Carbide Inserts

			
<p>07-9251 ARRUGA 16cm</p>	<p>07-9252 CASTROVIEJO 13cm</p>	<p>07-9253 - 07-9254 HEGAR 20cm 24cm</p>	<p>07-9255 - 07-9256 HALSEY 13cm 15cm</p>
			
<p>07-9257 - 07-9262 MAYO-HEGAR 16cm 18cm 20cm 24cm 26cm 30cm</p>	<p>07-9263 - 07-9268 DE-BAKEY 18cm 20cm 23cm 26cm 31cm 37cm</p>	<p>07-9269 - 07-9272 HEGAR-VASCULAR 14cm 18cm 20cm 23cm</p>	

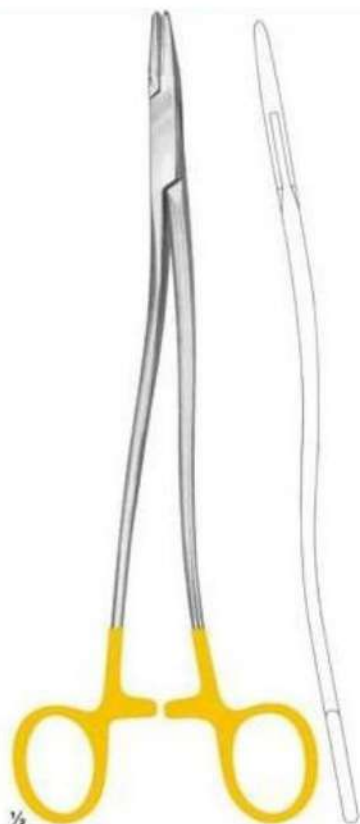

07-9273 - 07-9275
BOZEMANN

07-9273	20cm
07-9274	24cm
07-9275	26cm

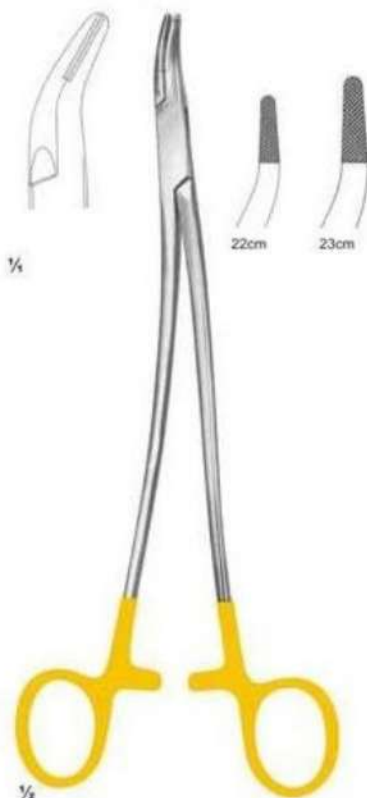

07-9276 - 07-9277
STRATTE

07-9276	22cm
07-9277	23cm



07-9278 - 07-9283
RYDER

07-9278	13cm
07-9279	15cm
07-9280	18cm
07-9281	20cm
07-9282	23cm
07-9283	26cm



07-9284 - 07-9288
RYDER-VASCULAR

07-9284	13cm
07-9285	15cm
07-9286	20cm
07-9287	23cm
07-9288	26cm



07-9289 - 07-9291
MARTIN







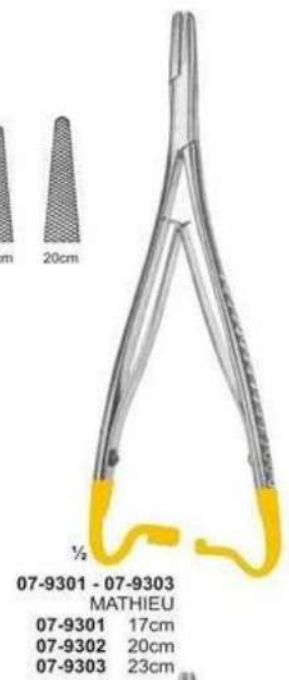

07-9289	15cm
07-9290	17cm
07-9291	20cm



07-9292 - 07-9294
SAROT

07-9292	18cm
07-9293	20cm
07-9294	26cm



 <p>17cm 20cm 24cm</p> <p>07-9314 - 07-9316 MATHIEU-RYDER 07-9314 17cm 07-9315 20cm 07-9316 24cm</p>	 <p>20cm</p> <p>07-9317 LICHTENBERG 20cm</p>	 <p>20cm 25cm</p> <p>07-9318 - 07-9319 LANGHALS 07-9318 20cm 07-9319 25cm</p>	 <p>20cm 25cm</p> <p>07-9320 - 07-9321 LICHTENBERG 07-9320 20cm 07-9321 25cm</p>
 <p>20cm 25cm</p> <p>07-9322 - 07-9323 LUETHY-BECK 07-9322 20cm 07-9323 25cm</p>	 <p>07-9324 - 07-9325 LUETHY-BECK 07-9324 20cm 07-9325 25cm</p>	 <p>18cm 20cm 23cm</p> <p>07-9326 - 07-9328 LANGENBECK 07-9326 18cm 07-9327 20cm 07-9328 23cm</p>	 <p>07-9329 - 07-9331 LANGENBECK 07-9329 18cm 07-9330 20cm 07-9331 23cm</p>



07-9332
STEVENS
15 cm



07-9333
KALT
14 cm



07-9334
KALT "HM"
14 cm



07-9335 - 07-9338
CASTROVIEJO
07-9335 14 cm STR
07-9336 17 cm STR
07-9337 14 cm CVD
07-9338 17 cm CVD



07-9339 - 07-9340
CASTROVIEJO
07-9339 14 cm
07-9340 17 cm



07-9341
CASTROVIEJO "HM"
13 cm



07-9342 - 07-9345
CASTROVIEJO "HM"
07-9342 14 cm smooth
07-9343 17 cm smooth
07-9344 14 cm serrated
07-9345 17 cm serrated



07-9346 - 07-9347
CASTROVIEJO-MICRO
 14, 5 cm
07-9346 14.5 cm STR
07-9347 14.5 cm CVD



07-9348 - 07-9349
CASTROVIEJO-MICRO
 14, 5 cm
07-9348 14.5 cm STR
07-9349 14.5 cm CVD

Ultra Fine



with catch

07-9350 - 07-9351
CASTROVIEJO
(KOSHIMA)
 14, 5 cm
07-9350 14.5 cm STR
07-9351 14.5 cm CVD



07-9352 - 07-9353
CASTROVIEJO
(KOSHIMA)
 14, 5 cm
07-9352 14.5 cm STR
07-9353 14.5 cm CVD



07-9354 - 07-9355
BARRAQUER
07-9354 11, 5 cm
07-9355 14 cm



07-9356 - 07-9357
BARRAQUER
07-9356 11, 5 cm
07-9357 14 cm



07-9358 - 07-9359
JACOBSON "HM"
07-9358 18, 5 cm
07-9359 21 cm



07-9360 - 07-9361
JACOBSON "HM"
07-9360 18, 5 cm
07-9361 21 cm



07-9362 - 07-9363
JACOBSON
07-9362 18, 5 cm
07-9363 21 cm



07-9364 - 07-9365
JACOBSON "HM"
 18 cm
07-9364 18 cm STR
07-9365 18 cm CVD



07-9366 - 07-9367
JACOBSON "HM"
 18 cm
07-9366 18 cm STR
07-9367 18 cm CVD



07-9368 - 07-9369
MICRO 2000
12 cm
07-9368 12 cm STR
07-9369 12 cm CVD



07-9370 - 07-9371
MICRO 2000
12 cm
07-9370 12 cm STR
07-9371 12 cm CVD



07-9372
MICRO 2000
15 cm



07-9373 - 07-9374
MICRO 2000
15 cm
07-9373 15 cm STR
07-9374 15 cm CVD



07-9375 - 07-9376
YASARGIL
16 cm
07-9375 16 cm STR
07-9376 16 cm CVD



07-9377
TOENNIS
 Elastic pattern for
 dura-or intestinal suture
 180 mm



07-9378
 Cutting Plier
 12 cm

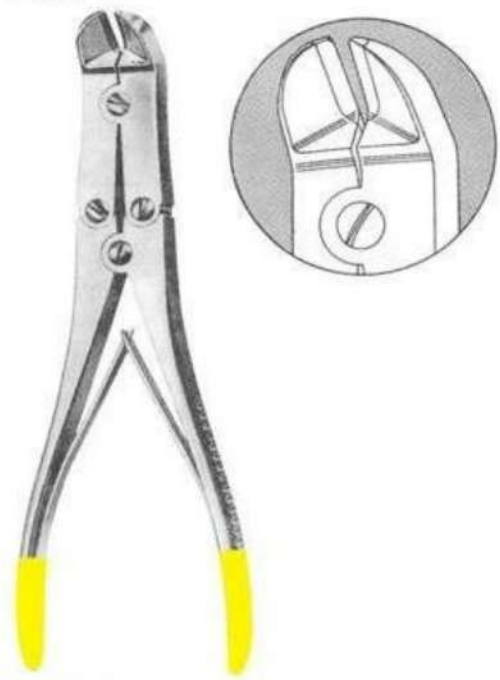

07-9379
MULLAR CLAUS
 22 cm

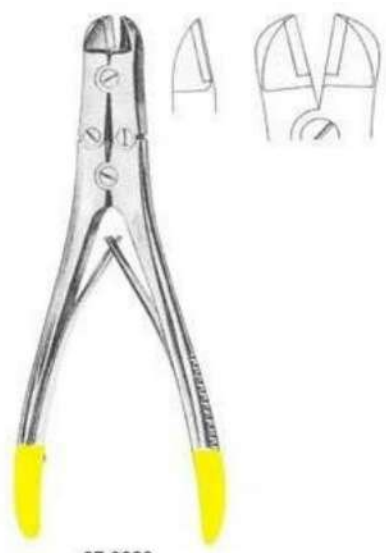

07-9380
 Plier
 17.5 cm



07-9381 - 07-9395
SCHIMMELBUSCH
without filter laterally
perforated lockable
by sliding mechanism.

∅ x H
sizes in mm

07-9381	80 x 80
07-9382	105 x 120
07-9383	140 x 140

07-9384	160 x 120
07-9385	160 x 150
07-9386	190 x 150

07-9387	190 x 190
07-9388	240 x 160
07-9389	240 x 240

07-9390	290 x 160
07-9391	290 x 240
07-9392	340 x 160
07-9393	340 x 340

07-9394	390 x 190
07-9395	390 x 290



07-9396
BOX
120 x 65 x 13mm
(without Bulldog clamps,
without silicone tape)



07-9397 - 07-9409
KONRICH

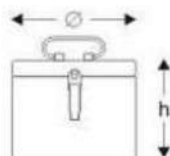

∅ x H
sizes in mm

07-9397	100 x 100
07-9398	150 x 150
07-9399	200 x 150

07-9400	200 x 190
07-9401	240 x 160
07-9402	240 x 230

07-9403	290 x 160
07-9404	290 x 240
07-9405	340 x 160

07-9406	340 x 240
07-9407	390 x 145
07-9408	390 x 240

07-9409	390 x 290
---------	-----------



07-9410
Box with support for
needle electrodes,
without instruments



07-9411
50 x 25 x 4,5 mm
07-9412
65 x 42 x 8 mm
07-9413
75 x 25 x 4,5 mm



07-9414
Box with support
120 x 65 x 13 mm
(with bulldog clamps)

07-9415
∅ 62mmx13mm
Interior box
perforated lid
and bottom.



07-9416
complete with perforated
interior box.
∅ 65mm x 15mm



Ø x H	Jar without lid	lid only	lid only with triangle hole
30x90mm	07-9417	07-9426	07-9435
50x100mm	07-9418	07-9427	07-9436
50x130mm	07-9419	07-9428	07-9437
50x175mm	07-9420	07-9429	07-9438
75x100mm	07-9421	07-9430	07-9439
75x130mm	07-9422	07-9431	07-9440
75x175mm	07-9423	07-9432	07-9441
100x175mm	07-9424	07-9433	07-9442
100x200mm	07-9425	07-9434	07-9443

07-9417 - 07-9443



07-9468
205 x 105 x 35 mm

07-9444 - 07-9467

L x B x H		Lid with knob	Lid without knob
07-9444	165 x 85 x 35 mm	07-9452	07-9460
07-9445	200 x 100 x 35 mm	07-9453	07-9461
07-9446	200 x 100 x 50 mm	07-9454	07-9462
07-9447	230 x 130 x 50 mm	07-9455	07-9463
07-9448	260 x 150 x 50 mm	07-9456	07-9464
07-9449	270 x 235 x 50 mm	07-9457	07-9465
07-9450	300 x 200 x 50 mm	07-9458	07-9466
07-9451	325 x 275 x 50 mm	07-9459	07-9467



07-9469 - 07-9470

- 07-9469** Sterilizing Forceps
consisting of:
1 Sterilizing Forceps, curved, 25 cm,
without ratchet, with lid for jar
1 jar with wide bottom plate (anti-tilt)
- 07-9470** ditto, with 32 cm long Sterilizing Forceps



Lid with knob

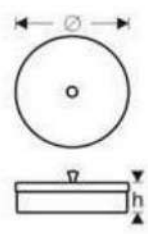

07-9478 25 cc graduated inside
07-9479 50 cc graduated inside

07-9471 - 07-9477

	∅ x H
07-9471	75 x 60 mm
07-9472	75 x 75 mm
07-9473	100 x 60 mm
07-9474	100 x 100 mm
07-9475	125 x 80 mm
07-9476	125 x 125 mm
07-9477	150 x 150 mm



07-9480 20 cc Medicine Spoon graduated inside



07-9481 ∅75 x 12 mm Tablet Tray



07-9482 ∅90 x 90 mm Metal Cup



07-9483 ∅75 x 80 mm Sputum Cup



Kidney Dish



Lid for kidney dishes

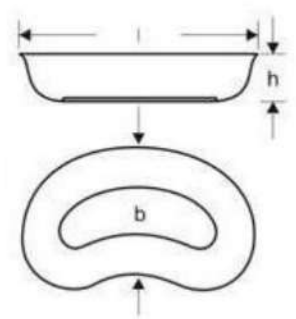

07-9484 - 07-9486

	L x B x H
07-9484	170 x 100 x 35 mm
07-9485	250 x 140 x 40 mm
07-9486	275 x 150 x 45 mm



07-9487 - 07-9494

	∅ x H		
07-9487	40 x 19 mm		0.05L
07-9488	61 x 30 mm		0.07L
07-9489	80 x 40 mm		0.14L
07-9490	116 x 50 mm		0.35L
07-9491	128 x 55 mm		0.45L
07-9492	147 x 65 mm		0.70L
07-9493	167 x 75 mm		1.10L
07-9494	187 x 85 mm		1.60L



07-9495 - 07-9499

	∅ x H		
07-9495	116 x 35 mm		0.30L
07-9496	128 x 38 mm		0.40L
07-9497	147 x 40 mm		0.50L
07-9498	157 x 45 mm		0.75L
07-9499	187 x 45 mm		1.00L



07-9500
∅ 110 x 28 mm 0.15L



07-9501
100 cc = 0.1L
graduated
inside



07-9502 - 07-9505
07-9502 0,25L
07-9503 0,50L
07-9504 1,00L
07-9505 2,00L
graduated
inside



07-9506
235 x 190 x 40 mm



07-9507
∅ 220 x 70 mm



07-9508
∅ 50 x 100 mm
Powder Pot



07-9509
∅ 50 x 75 mm
Methot With Lid



07-9510
∅ 50 x 75 mm
Methot Without Lid



graduated inside upto 600ml with handle
07-9511



graduated inside upto 600ml
07-9512



07-9513
PLACENTA PAN



07-9514 - 07-9515
BED PAN
07-9514 ∅ 235 mm
07-9515 ∅ 310 mm



07-9516
Sauerbruch
210 x 125 x 17 mm
perforated lid and
bottom



07-9517
Sauerbruch
210 x 125 x 17 mm
perforated lid and
bottom



07-9518
150 x 95 x 13 mm



07-9519
150 x 95 x 13 mm
perforated lid and
bottom



07-9520
150 x 95 x 13 mm
perforated bottom



07-9521
150 x 95 x 13 mm
perforated lid and
bottom



07-9522
150 x 95 x 13 mm



07-9523
150 x 95 x 13 mm
perforated lid and
bottom



07-9524
150 x 95 x 11 mm
Needle tray perforated
bottom



07-9525
Deponette
245 x 135 x 35mm
Perforated bottom,
with textile filter ref.



07-9526
Deponette
245 x 135 x 50mm
Perforated bottom,
with textile filter ref.



07-9527
Deponette
245 x 135 x 60mm
Perforated bottom,
with textile filter ref.



Perforated Bottom



07-9528 - 07-9532

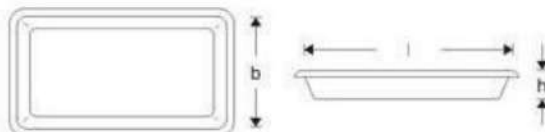

satin finish	size in mm l x b x h
07-9528	230 x 165 x 30
07-9529	300 x 155 x 30
07-9530	300 x 175 x 40
07-9531	350 x 240 x 36
07-9532	400 x 300 x 50

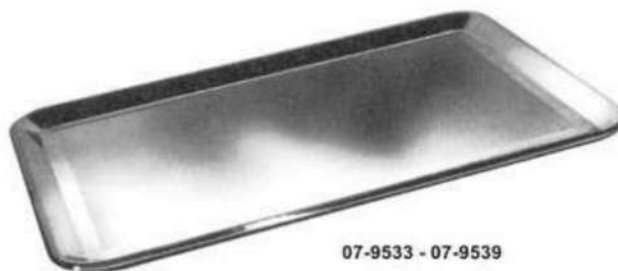

07-9533 - 07-9539

satin finish	size in mm Ø x H
07-9533	210 x 160 x 10
07-9534	240 x 180 x 10
07-9535	310 x 150 x 10
07-9536	310 x 210 x 10
07-9537	350 x 240 x 10
07-9538	400 x 270 x 20
07-9539	420 x 280 x 10



07-9540 - 07-9550

	L x H x B	
07-9540	230 x 130 x 50	mm
07-9541	260 x 150 x 50	mm
07-9542	275 x 235 x 50	mm
07-9543	300 x 200 x 50	mm
07-9544	325 x 275 x 50	mm
07-9545	420 x 175 x 50	mm
07-9546	230 x 130 x 75	mm
07-9547	260 x 150 x 75	mm
07-9548	300 x 200 x 75	mm
07-9549	325 x 275 x 75	mm
07-9550	420 x 175 x 75	mm

Sterilizing tray of wire mesh
for container 30cm long

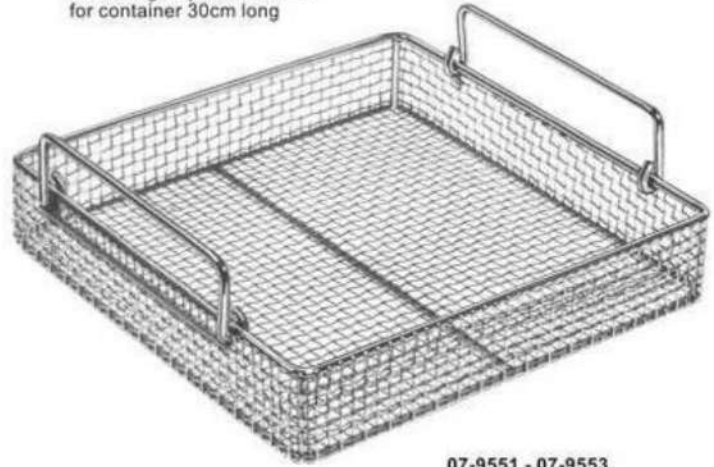

07-9553
250 x 250 x 50mm

07-9551 480 x 250 x 50 mm
07-9552 520 x 250 x 75 mm
07-9553 520 x 250 x 100 mm
 Sterilizing Trays of wire mesh
for container 60cm long.

07-9551 - 07-9553



Sterilizing tray of perforated steel sheet

07-9554 - 07-9559

07-9554 240 x 240 x 50 mm
07-9555 240 x 240 x 80 mm
07-9556 240 x 240 x 100 mm
07-9557 480 x 260 x 50 mm
07-9558 520 x 260 x 80 mm
07-9559 520 x 260 x 100 mm

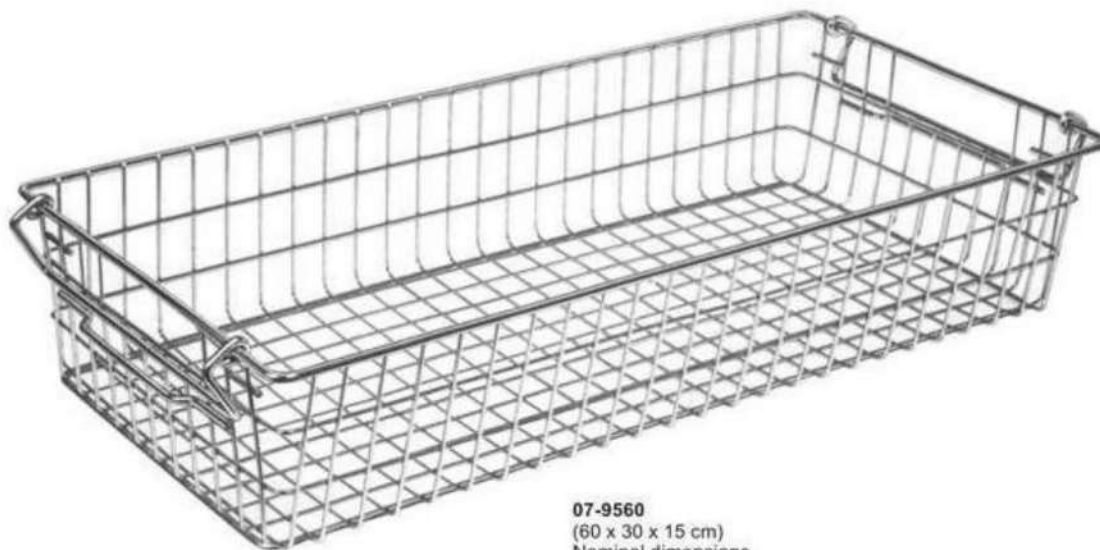

07-9560
(60 x 30 x 15 cm)
Nominal dimensions



07-9561
(60 x 30 x 30 cm)
Nominal dimensions

Shears	42	Nerve and Vessel Hooks	116
Bonney Dissecting Forceps	58	Raspatories	335
Tissue Forceps	65	Retractors	130,160
Bose Self-Retaining Retractors	151	Rongeurs	314-316,318
Trachea Retractors	118	Tampers	351
Tracheal Hooks	256	Castaneda Multi Purpose Clamps	265
Bowel Scissors	46	Castroviejo Blade Holder	19
Bowles Stethoscopes	2	Caliper	11
Bowman Probes	109	Micro Spring Scissors	23
Boxes	422	Needle Holders	96,412,413,417,418
Boynton Needle Holders	101	Tissue Forceps	62
Boys-Allis Artery Traction Forceps	73,168	Castroviejo-Koshima Needle Holders	418
Bozemann Needle Holders	414	Castroviejo-Micro Needle Holders	418
Uterine Dressing Forceps	225,226	Catlin Knife	16
Uterine Scissors	44	Cerclage Instruments	384
Vaginal Speculums	219	Wire Tightner	383
Bozemann-Douglas Uterine Dressing Forceps	226	Chaput Artery Traction Forceps	73,168
Bozemann-Fritsch Uterine Flushing Tube	245	Charging Set	4
Brain Knives	13	Charriere Amputation Saws	321,322
Braun Artery Traction Forceps	73	Cheatle Forceps with Jar	423
Cranioclast	254	Cheek and Lip Retractors	5
Tenaculum Forceps	227	Cheron Sponge Forceps	69
Uterine Depressor	224	Chisels	351-353,355,356
Vaginal Speculums	215	Choledochus Forceps	195
Braun-Stadler Scissors	45,51,248	Cilia Forceps	66
Breisky Pelvimeter	246	Circumcision Clamps	207
Vaginal Speculums	211,217	Citelli Punches	310
Brock Micro Needle Holders	97	Citelli-Beyer Punches	310
Brodie Director	107	Clar Head Light	4
Brom Vein Hook	115	Claus Van Eicken Needle	104
Bronchus Clamps	277	Cleaning Brush	256
Forceps	295	Clip Applying and Removing Forceps	111
Brophy Dissecting Forceps	56	Clip Applying Forceps	111
Tissue Forceps	64	Cloth Scissors	50,51
Brown Forceps	63	Cloward Lamina Spreader	161
Bruenings Extension Cannulae	240	Retractors	159
Tongue Depressor	5	Coagulation Hooks	116
Tonsil Knife	17	Suction Cannulae	404
Brunner Guiding Probes	105,106	Coakley Antrum Trocars	208
Ligature Needles	105	Coarctation Clamps	272,273,288
Retractors	137	Collin Abdominal Retractor	162
Rib Shears	296	Clip Applying Forceps	111
Bruns Bandage and Plaster Scissors	51,394	Druck Pressure	11
Bone Curettes	344	Elevating Forceps	233,235
Bryant Sponge Forceps	67	Intestinal Grasping Forceps	169,171
Buchs Retractors	130	Kidney Elevating Forceps	202
Buchwald Tongue Depressors	5	Organ and Tissue Grasping Forceps	71
Buck Cotton Applicators	110	Ovum Curettes	243
Percussion Hammer	1	Pelvimeters	246
Buck-Gramcko Bone Levers	325	Retractors	123
Buelau Empyema Trocars	208	Rib Shears	296
Bulldog Clamps	77,78	Scalpel Handle	20
Bumm Ovum Curettes	243	Sponge Forceps	69,71
Ovum Forceps	232	Tongue Forceps	6
Uterine Curettes	242	Vaginal Speculums	209
Bunt Safety Pin	76	Collin-Hartmann Retractors	123
Bushe Bone Curettes	345	Combined Suction and Irrigation Cannulae	404
		Comedone Extractors	18
		Compression Forceps	94-95
		Conductors	323
		Cone Knife	17
		Contractors	307
		Converse Dura and Skin Retractor	117
		Needle Holder	98
		Cooley Aortic Dilators	260
		Clamps	284-288
		Multi Purpose Clamps	266,287
		Sternotomy Spreaders	305
		Cooley-Beck Anastomosis Clamps	284
		Cooper Surgical Scissors	31
		Ligature Needle	104

C

Calipers	11
Canad.Modell Meniscus Knives	379
Cardiovascular Scissors	40
Caroll Caliper	11
Carotid Clamps	294
Carrel Delicate Haemostatic Forceps	79
Cartilage Forceps	377
Knives	13,16
Caspar Bone Curettes	346
Knot tier and Ligature Adjuster	106
Micro Scissors	24

Coronary Artery Scissors	39	De Bakey-Pean Atraumata Haemostatic Forceps	268
Cottle Bulldog Scissors	33	De Bakey-Satinsky Tengential Occlusion Clamps	272
Chisels	353	De Lee Pelvimeter	246
Forceps	61	Dean Tonsil Scissors	41
Mallets	348	Deaver Retractors	139-143
Nasal Scissors	41	Surgical Scissors (Flat Lock)	32
Osteotomes	353	Dejerine Percussion Hammer	1
Raspatories	333,335	Delicate Dissecting Forceps	55-56
Retractors	122	Haemostatic Forceps	79-81
Wound Retractors	117	Scissors	26-29,33,41
Cotton Applicators	109,110,224	Tissue Forceps	62
Crafoord Auricle Clamps	294	Demel Wire Guide	384
Delicate Haemostatic Forceps	81	Denhardt Mouth Gag	6
Crafoord-Sellers Auricle Clamps	294	Denis Browne Intestinal Forceps	65,170
Cranioclast	254	Derf Needle Holders	98
Crile Delicate Forceps	80	Dermotomes	22
Needle Holders	100	Derra Multi Purpose Clamps	266
Nerve and Vessel Hook	115	Derra-Cooley Anastomosis Clamps	285
Retractors	123	Deschamps Ligature Needles	103,104
Crile-Murray Needle Holders	98	Desjardins Forceps	90,194
Crile-Wood Needle Holders	98	Gall Duct Probes	197
Cusco Vaginal Speculums	209,210	Gall Stone Forceps	199
Cushing Dissecting Forceps	56,411	Gall Stone Probes	198
Nerve and Vessel Hooks	115,116	Desmarres Retractors	122
Retractors	122	Deponette Storing Cases	429
Rongeurs	316	Diagnostic Sets	8
Cushing-Kocher Retractors	122	Dick Anastomosis Clamps	184,276
Cushing -Taylor Forceps Bayonet	411	Atraumata Compression Clamps	94
Czerny Gall Stone Forceps	199	Dieffenbach Bulldog Clamps	77
Retractors	124	Scalpels	14
Tenaculum Forceps	229	Diethrich Aorta Clamps	280
		Scissors	39
		Dilators	256,257
		Dingmann Bone Holding Forceps	358
		Directors Probes	107
		Distraction Sets	382
		Dissecting Forceps	57,58,87-90,
			263,269,291-
		Knives	292,411
		Scissors	12
			33-38,409
		Dittel Gall Duct Dilators	198
		Urethral Bougies	206
		Doyen Gall Bladder Forceps	196
		Intestinal Clamps	174-176
		Myoma Screws	236
		Needle Holder	98
		Ovum Forceps	232
		Directors	107
		Raspatories	298,337
		Retractors	146-147
		Towel Clamps	75
		Vaginal Speculums	216,217
		Doyen-Child Fixation Device	147
		Dressing Forceps	67-71
		Sterilizing Drums	422
		Drilling Chucks	383
		Duplay Sponge Forceps	67
		Tenaculum Forceps	228
		Durogrip Bone Rasps	340
		Wire Holding Forceps	386
		Durotip Angle Wire Cutters	388
		Wire Cutting Pliers	389,391
		Wire Cutting Scissors	388
		Dura Knives	18
		Retractors	117
		Scissors	40
		Duval Intestinal Forceps	65,169
		Intestinal Grasping Forceps	170
		Lung Grasping Forceps	290
		Duval-Collin Intestinal Grasping Forceps	169

D

Dandy Delicate Forceps	79
Dardik Multi Purpose Clamps	289
Dartigues Elevating Forceps	233
Kidney Elevating Forceps	202
Daubenspeck Bone Curettes	345
Davidson Scapula Retractors	139,308
Davis Vascular Spatulas	258
De Bakey Anastomosis Forceps	186
Aorta Clamps	281
Aorta-Aneurysm Clamps	278,279
Ateriectomy Scissors	34
Bulldog Clamps	78
Clamps	264-283
Coarctation Clamps	272,273
Dissecting Forceps	263
Forceps (Full range)	60,172,263
Multi Purpose Clamps	266,283
Needle Holders	413
Offset Scissors	39
Patent-Ductus Clamps	273
Peripheral-Vascular Clamps	274,275
Retractors	157
Rib Spreaders	303
Ring Handle Bulldog Clamps	264
Scissors	410
Suction Cannulae	309,401
Tangential Occlusion Clamps	271,272
Vascular Clamps	274,275
Vascular Dilators	257
Vessel Scissors	39
De Bakey-Beck Vena Cava Clamps	270
De Bakey-Bainbridge Atraumata Haemostatic Forceps	267
De Bakey-Harken Vena Cava Clamps	271
De Bakey-Hess Bulldog Clamps	77
De Bakey-Kelly Atraumata Haemostatic Forceps	268
De Bakey-Mixter Dissecting & Ligature Forceps	269

E

Echlin Bone Rongeurs	369
Eiselsberg Ligature Scissors	47
Needle Holders	100
Eiselsberg-Mathieu Needle Holder	101
Elevators	258,299,324, 331-336
Elsching Forceps	62
Embolus Grasping Forceps	257
Emmet Fistula Hooks	121
Sponge and Dressing Forceps	69
Empyema Trocars	208
Enderectomy Strippers	259
Endospecula For Cervix	223
Engel Plaster Saw	393
Engl. Mod. Towel Clamps	75
Enucleation Scissors	35
Epsiotomy Scissors	45,248
Eppendorf Biopsy Forceps	240
Esmarch Bandage & Plaster Scissors	51,394
Plaster Knife	393
Ether Mask	6
Examination and Measuring Instruments	11
Exploration Hooks	116
Extension Cannulae	240
Cord	4
Extraction Pliers	387
Eye Scissors	23

F

Farabeuf Bone Holding Forceps	360
Raspatories	336
Retractors	123
Farabeuf-Lambotte Bone Holding Forceps	360
Farrell Cotton Applicators	109,110
Faure Biopsy Forceps	238
Peritoneum Forceps	91
Favoloro Artery Scissors	39
Feilchenfeld Splinter Forceps	66
Female Catheters Urinary Instruments	206
Femur Retractor	157
Fergusson Bone Holding Forceps	359
Haemorrhoidal Forceps	193
Suction Tube	402
Fergusson-Ackland Mouth Gag	6
Ferris-Smith-Kerrison Punches	312
Fiber Optic Batery Handle	10
Fine Scissors	33,34,410
Finger Nail Drill	392
Nail Instruments	392
Ring Saw	392
Finocchio Dissecting & Ligature Forceps	89,291
Needle Holders	415
Rib Spreaders	300,301
Finocchio-Burford Rib Spreaders	302
Finsen Self-Retaining Retractors	151
Finsterer Combined Cannulae	404
Fishtail Chisel	353
Fistula Hooks	121
Fixation Clamp	380
Discs	381
Flap Knives	16
Flat Nosed Pliers	386,387
Foerster-Ballenger Sponge Holding Forceps	70
Fomon Dissecting Scissors	35
Forceps	60-61
Nasal Scissors	41
Rasps/Bone File	340
Retractors	120

Forceps	52-66
With Tungsten Carbide Inserts	411-412
Ford-Bowles Stethoscopes	2
Foregger Laryngoscopes	10
Fowler Tonsil Knife	17
Francke Blood Lancet	7
Frazier Fine Wound Retractors	117
Suction Tube	402
Freer Chisels	351
Fine Wound Retractors	117
Gouges	351
Raspatories	332,333
Vascular Spatulas	258
Freer-Yasargil Raspatories	333
Frenzel Tongue Depressors	5
Fricke Artery Forceps	58,82
Fritsch Retractors	146

G

Gall Bladder Forceps	196
Trocars	208
Gall Duct Dilators	198
Forceps	194-195
Probes	197
Scissors	196
Gall Stone Forceps	199
Scoops	198
Gallaher Bone File	339
Gastro-Intestinal Forceps	181
Gauss Scalp Flap Forceps	251
Gelpi Retractors	157
Vaginal Retractors	220
Genito-Urinary Instruments	205-207
Gerald Dissecting Forceps	56
Tissue Forceps	64
Gerster Bone Clamps	364
Giertz- Stille Rib Shears	296
Gigli Wire Saws and Handle	323
Gill Forceps	62
Gill-Hess Forceps	62
Gillies Fine Wound Retractors	117
Needle Holders	100
Tissue Forceps	64
Glass Rods	236
Glover Anastomosis Clamps	269,270
Bulldog Clamps	78
Vena Cava Clamps	270
Gluck Rib Shears	296
Goldmann-Fox Scissors	410
Good Tonsil Scissors	41
Gorney Suction Dissector	402
Gosset Abdominal Retractors	164
Gouges	351-353,355-356
Graduated inside	425
Graefe Fine Wound Retractors	117
Knives	14
Nerve and Vessel Hooks	115
Tissue Forceps	63
Grave Vaginal Speculums	211
Gray Forceps	90,195
Green-Armytage Obstetrics Forceps	251
Gross Sponge Forceps	67
Gruenwald Forceps	61
Guedel-Negus Laryngoscopes	9
Guide	259
Guiding Probes	105,106
Guthrie Fine Wound Retractors	117
Guyon Catheter Guide	206

Kidney Clamps	200
Urethral Bougies	206-207
Gynaecological Instruments	245
Scissors	43-44

H

Haase Tamper	351
Reposition Forceps	357
Haberer Intestinal Spatulas	150
Haemostatic ATRAUMATA Forceps	267,268
Haemostatic Forceps	70,79-86,92
Haemorrhoidal Forceps	192-193
Hajak Irrigation Cannula	197
Mallets	349
Hajak-Kofler Punches	311
Halogen Replacement Lamp	10
Halle Bone Curettes	345
Raspatories	332
Vascular Spatulas	258
Halsey Needle Holder	98,413
Halsted Delicate Forceps	80,81
Halsted-Mosquito Delicate Forceps	79,81
Handles	7,20,21,137,215, 219,240,259,261, 323,399
Harken Vena Cava Clamps	293
Hartmann Intestinal Clamps	174
Harvey Wire Cutting Scissors	48,388
Harrington Retractors	138
Harrington-Pemberton Retractors	308
Head Bands	3
Lights	4
Mirrors	3
Heaney Hysterectomy Forceps	92,93
Needle Holders	415
Heaney (Hegar) Needle Holders	99
Heath Clip Removing Forceps	111
Mallet	350
Hebra Comedone Extractors	18
Hegar Needle Holders	99,413
Uterine Dilators	221-222
Hegar-Olsen Needle Holders	100
Hegar-Vascular Needle Holders	413
Hegenbarth Clip Applying Forceps	111
Heiss Delicate Haemostatic Forceps	81
Ligature Forceps	89
Heister Mouth Gag	6
Hemingway Bone Curettes	343
Hennig Plaster Spreader	397
Hepp-Scheidle Needle Holders	412
Herberhold Pocket-Accu	4
Herff Membrane Puncturing Forceps	247
Herget Biopsy Forceps	190
Herrick Kidney Pedicle Clamps	201
Hertzler Retractors	164
Rib Spreaders	300
Herz Tendon Seizing Forceps	72
Hess Forceps	62
Hey Groves Bone Holding Forceps	362
Heymann-Knight Nasal Scissors	41
Heywood-Smith Gall Bladder Forceps	196
Haemorrhoidal Forceps	192
Ovum Forceps	231
Sponge Holding Forceps	71
Tongue Forceps	6
Hoepfner Vessel Clamps	292
Hohmann-Aldinger Bone Levers	329
Holzbach Abdominal Retractor	162
Hopkins Plaster Instruments	393
Hose Connection	244

Hosel Retractors	131
Hosemann Choledochus Forceps	195
Hospital Wares	422-432
House Irrigation Cannulae	404
Howarth Raspatories	333
Huber Handle	240
Hunt Tumor & Vessel Forceps	54
Hunter Splinter Forceps	66
Hurd Ligature Needles	104
Hysterectomy Forceps	92-94

I

Incision Surgical Scissors	32
Inge Lamina Spreaders	161
Instrument Boxes	422,423
Instruments for Micro Tubal Operation	236
Interosseous Knife	16,319
Intestinal Clamps	173-180
Forceps	65,168-171
Spatulas	149-150
Intestinal And Pylorus Clamps	183
Iowa Membrane Puncturing Forceps	247
Irrigation Cannulae	257,404
Israel Retractors	127
Ives-Fansler Anusscopes	189

J

Jackson Tendon Seizing Forceps	72
Tracheal Tubes	255
Vaginal Speculums	214
Jackson Burrows Retractors	157
Jacobs Tenaculum Forceps	230
Jacobson Bone Curettes	342
Needle Holder	96,419
Jaeger Fine Wound Retractors	117
Jager Tendon Seizing Forceps	72
Jameson Dissecting Scissors	34
Needle Holder	99
Jansen Bone Curettes	342,343
Bone Rongeurs	366,367
Forceps	61
Head Light with Plastic Band	4
Raspatories	336
Retractors	151
Jars	423,424
Jenkner Instrument set for Tunnelling and Pulling-through Vascular Grafts	261
Jeweler Forceps	52
Bulldog Clamps	77
Joll (Friedman) Retractors	157,220
Jones Towel Clamps	75
Jonesco Ligature Needles	104
Jordan Instruments	385
Joseph Bone File	339
Delicate Scissors	29
Fine Wound Retractors	117
Nasal Knives	18
Raspatories	331
Judd-Allis Tissue Grasping Forceps	168
Judd-Masson Bladder Retractors	204

K

Kader Intestinal Spatula	149
Kalt Needle Holders	96,417

Kazanjian Bone Cutting Forceps	373	Lahey (Sweet) Dissecting and Ligature Forceps	90
Kelly Delicate Forceps	79	Gall Duct Forceps	194
Delicate Scissors	29	Lambotte Bone Holding Forceps	363
Obstetrical Forceps	254	Osteotomes	353,354
Ovum Forceps	231	Rib Raspatories	299
Proctoscopes	189	Lamina Spreaders	161
Retractors	133,145	Laminectomy Retractors	155,156,158
Sphincteroscopes	189	Landolt Coagulation Suction Cannulae	404
Sponge Holding Forceps	71	Enucleation Scissors	35
Kern-Lane Bone Holding Forceps	361	Raspatories	335
Kerpel Bone Curettes	343	Suction Cannulae	403
Kerrison Punches	311	Lane Bone Holding Forceps	361,362
Kerrison-Jacoby Punches	312	Bone Levers	326
Kersting Anastomosis Forceps	186	Intestinal Forceps Twin	181
Kidney Clamps	200-201	Intestinal Grasping Forceps	170
Dishes	425	Tissue Forceps	65
Elevating Forceps	202	Towel Clamps	75
Stone Forceps	203	Lane Trethowan Bone Levers	326
Killian Bone Shears	42	Lange Fistula Hooks	121
Probes	109	Lange-Hohmann Bone Levers	326
Raspatories	333	Langenbeck Amputation Saws	322
Rectal Specula	187	Bone Holding Forceps	359
Kilner Dissecting Scissors	34,410	Bone Levers	324
Fine Wound Retractors	117	Elevators	324
Needle Holder	98	Flap Knife	16
Kirschner Guiding Probes	106	Head Light	4
Retractors	167	Needle Holders	416
Wire Traction	380,381	Raspatories	336
Kirschner-Balfour Blade	167	Resection Knives	14,319
Klapp Tendon Hooks	121	Retractors	128
Kleinschmidt Spur Crusher	182	Rib Raspatories	299
Klima Rosegger Sternal Puncture Needle	208	Langenbeck-Green Retractors	120
Knives	12-14,16-18,	Langenbeck-Mannerfelt Retractors	119
	319	Langhals Needle Holders	416
Knot tier and Ligature Adjuster	106	Laryngeal Mirrors	7
Knowles Bandage Scissors	49	Laryngoscopes	9,10
Kocher Bladder Spatulas	204	Lathbury-Farrell Cotton Applicators	109,110
Bone Retractors	125,126	Lawrence Forceps	89
Guiding Probes	106	Lazar Micro Forceps	52
Haemostatic Forceps	84	Lebsche Conductor for Wire Saws	323
Intestinal Clamps	175,177,178	Sternum Chisels	296
Retractors	122,125,126,	Lees Bronchus Clamps	277
	129,130	Legueu Bladder Retractors	204
Suture Needles	104	Bladder Spatula	204
Kocher-Langenbeck Retractors	128	Leksell-Stille Bone Rongeurs	370
Kocher-Ochsner Haemostatic Forceps	85	Leland-Jones Peripheral-Vascular Clamps	274,275
Koenig Guiding Probes	106	Lempert Bone Curettes	345
Elevators	324	Bone Rongeurs	367
Raspatories	331	Lerliche Intestinal Spatula	149
Retractors	122	Lewis Bone Rasps	339
Koerte Retractors	127	Lewkowitz Ovum Forceps	253
Kogan Endospecula	223	Lexer Gouges	355,356
Kolle Micro Needle Holders	7	Osteotomes	355,356
Konrich Sterilizing Drums	422	Scissors	37,406
Krause Biopsy Tips	240	Lexer-Mini Gouges	355
Krayenbuhl Nerve and Vessel Hooks	116	Osteotomes	355
Kristeller Vaginal Speculums	211-214	Lichtenberg Needle Holders	416
Kronecker Ligature Needles	103	Ligature Adjuster	106
Kronlein Haemostatic Forceps	82	Forceps	53,58,87-90,
Krypton Replacement Lamp	10		269,291-292
Kuhne Cover Glass Forceps	55	Needles	103-105
Kummel Intestinal Spatula	149	Pliers	386
Kustner Tenaculum Forceps	229	Scissors	47
		Lister Bandage Scissors	50
		Sinus Forceps	67
		Liston Bone Cutting Forceps	373,375
		Knife	16
		Liston-Key-Horsley Bone Cutting Forceps	297,376
		Liston-Stille Bone Cutting Forceps	297,376
		Littauer Ligature Scissors	47
		Littler Dissecting Scissors	33

L

Laborde Tracheal Dilators	256
Lahey Artery Traction Forceps	73
Gall Duct Forceps	194
Tenaculum Forceps	228

Littlewood Tenaculum Forceps	230	Mayo-Adams Retractors	154
Liver Retractor	145	Mayo-Harrington Scissors	36,409
Lloyd-Davis Sigmoid Anastomosis Forceps	185	Mayo-Hegar Needle Holders	99,413
Lloyd-Davies Rectal Scissors (Goligher's)	46	Mayo-Lexer Scissors	37,406
Lockhart-Mummary Probes	107	Mayo-Noble Scissors	36
Locklin Scissors	41	Mayo-Robson Intestinal Clamps	180
Lockwood Intestinal Grasping Forceps	169	Mayo-Stille Scissors	35,36,406
Logan modif. Reill Self-Retaining Retractors	151	Mc Indoe Forceps	56
Lopez-Reinke Tonsil Dissector	402	Tissue Forceps	64
Lorna Towel Clamps	76	Mc Kenty Raspatories	331
Loute Wire Tightener	383	Mcintosh Laryngoscopes	10
Love-Gruenwald Rongeurs	314,316,317	Mead Bone Rongeurs	367
Lower Forceps	90,194	Mallets	348
Lowman Bone Clamps	364	Raspatories	333
Lowman-Gerster Bone Clamps	364	Measuring Instruments	11
Lowman-Hoglund Bone Clamps	364	Medicine Cups	424
Lucae Forceps	61	Spoons	424
Lucas Bone Curettes	343	Membrane Puncturing Forceps	247
Chisels	352	Meniscus Knives	378,379
Gouges	352	Forceps	377
Luethy-Beck Needle Holders	416	Mercedes Retractor	306
Luer Bone Rongeurs	366,368	Metacarpal Saw	322
Haemorrhoidal Forceps	192	Metal Cups	424
Retractors	123	Round Boxes	424
Tracheal Tubes	255	Methot Pot	426
Luer-Friedmann Bone Rongeurs	365	Metzenbaum Dissecting Scissors	26,38,407,408
Luer-Koerte Gall Stone Scoops	198	Metzenbaum-Fino Dissecting Scissors	407,408
Luer-Stille Bone Rongeurs	371,372	Meyer Reposition Forceps	357
Lung Dissecting Forceps	65	Meyerding Retractors	120,134
Grasping Forceps	290	Michel Clip Applying and Removing Forceps	111
Spatulas, Retractors	138-143,308-309	Rhinoscopic Mirrors	7
Luxation Lever	330	Micro Dissecting Scissors	23-25
		Dissecting Scissors Bayonet	25
		Forceps	52,53
		Jeweller Types Forceps	52
		Ligature Forceps Bayonet	53-54,87
		Needle Holders	96-97,420
		Suture Tying Forceps	52
		Micro-2000 Needle Holders	420
		Micro-Adson Forceps	55,62,87
		Micro-Halsted Delicate Forceps	79
		Microscopic Forceps	55
		Middeldorpf Retractors	130
		Mikulicz Forceps	86
		Intestinal Spatula	149
		Peritoneum Forceps	91
		Retractors	144,145
		Millium Knives	18
		Miller Laryngoscopes	9
		Rasps	340
		Millin Bladder Neck Spreader	205
		Bladder Retractors	204
		Center Blade for Retractors	204
		Ligature Holding Forceps	101
		Lobe Grasping Forceps	205
		Mills Gall Duct Scissors	196
		Mirror Handles	7
		Mirrors for Head light	4
		Mixer Dissecting and Ligature Forceps	89,90,292
		Gall Duct Forceps	195
		Mixer-O'Shaughnessy Forceps	89
		Modell Piccolo Cotton Applicators	109
		Mod. USA Plaster Spreader	397
		Modell Tubingen Retractors	135
		Mollison Self-Retaining Retractors	154
		Molt Raspatories	333
		Moeltgen Goniometer	11
		Moncorps Millium Knives	18
		Mosquito Atraumata Forceps	267
		Morris Anastomosis Clamps	186
		Ascending Aorta Cross Clamps	276

M

Mac Donald Raspatories	333
Magill Forceps	8
Maier Sponge Forceps	68
Maltz Bone Rasps	339
Mallets	348-350
Mannerfelt Osteotomes	351,352
Raspatories	334
Retractors	119
Markwalder Rib Rongeurs	297
Marquardt Bone Rongeurs	368
Martin Meniscus and Cartilage Forceps	377
Needle Holders	414
Pelvimeters	246
Retractors	135
Tenaculum Forceps	228
Uterine Probes	224
Vaginal Speculums	218
Martini Bone Curettes	342
Masing Retractors	122
Masson Needle Holders	99
Masson-Luethy Needle Holders	99
Mathieu Foreign Body Forceps	205
Needle Holders	101,415
Rectal Specula	188
Retractors	124
Vaginal Speculums	215
Mathieu-Kocher Needle Holders	415
Mathieu-Ryder Needle Holders	416
Mathieu-Stille Needle Holders	101
Mathieu-Vascular Needle Holders	415
Mayo Gall Duct Probes	197
Safety Pin	76
Scissors	35-37,408
Uterine Probes	224

Retractors	133
Morse Sternotomy Spreaders	304
Mouth Gags	6
Moynihan Forceps	86
Gall Stone Probes	197
Intestinal Clamps	179
Muehling Raspatories	335
Mueller Retractors	151
Mullar claus Wire cutting Plier with T.C	421
Multi-Purpose Clamps	283,286-287,289
Muller Fine Wound Retractors	117
Ligature Forceps	77
Micro Forceps	53
Micro Needle Holders	97
Vessel Clips	77
Murphy Head band	3
Murphy-Lane Luxation Levers	330
Museux Artery Traction Forceps	73
Tenaculum Forceps	230
Myoma Instruments	236
Screws	236
Myomatome	17,236
Myrtle Leaf Probes	108

N

Naegele Obstetrical Forceps	249
Nagel Micro Scissors	25
Nail Extraction Forceps	392
Scissors	49
Splitting Forceps	32,392
Nasal Scissors	41
Suction Tubes	402
Naujoks Wire Scissors	48
Needle Cases	422,428
Needle Holders	7,96-101
Needle Holders With Tungsten Carbide Inserts	412-416
Needle Sterilizing Cases	427
Neff Meniscus Knives	378
Negus Tonsil Forceps	86
Nelaton Directors	107
Nelson Lung Dissecting Forceps	65
Lung Grasping Forceps	290
Trocars	208
Nelson-Metzenbaum Dissecting Scissors	38
Nerve and Vessel Hooks	115-116
Neubuser Tubal Seizing Forceps	236
Neuro-Surgery Scissors	40
Nissen Dissecting and Ligature Forceps	87
Gall Duct Forceps	194
Non-Traumatic Haemostatic Forceps	267,268
Norfolk and Norwich Retractors	155
Noto Ovum Forceps	231
Sponge Holding Forceps	71
Novak-Schoeckaert Endometrial Biopsy Curettes	237
Noyes Micro Spring Scissors	23
Nurse's Scissors	50
Nussbaum Intestinal Clamps	179

O

Obstetrical Forceps	247,249,250-254
Pelvimeters	246
Scissors	45,248
Obstetric Instruments	246-254
Ochsner Aorta Clamps	281
Gall Duct Probes	197
Ligature Forceps	58
Trocars	208
Oehler Dissecting Forceps	412

Oldberg Rongeurs	317
Olivecrona Bone Rongeurs	368
Dura Scissors	40
Trigeminal Knife	17
Wire Saws	323
Ombredanne Mallets	350
Operating Scissors	43,44,405
Organ and Grasping Forceps	70,71,74,170,171
Osteotomes	351-356
Osteophyte Rongeurs	318
Otoscope Complete Set	8
Battery Handle	8
Overholt Dissecting and Ligature Forceps	88
Overholt-Geissendoerfer Dissecting and Ligature Forceps	88
Overholt-Mixer Dissecting and Ligature Forceps	87
Ovum Curettes	243
Ovum Forceps	231,232

P

Parker Retractors	123
Parker-Kerr Anastomosis Clamps	184
Parry-Cooley Aorta Clamps	288
Partsch Chisels	352
Gouges	352
Raspatories	331
Partsch Mod.Lange Raspatories	331
Passow Tamper	351
Patent-Ductus Clamps	273,288
Patella Forceps	358
Paulsen Raspatories	332
Payr Guiding Probes	106
Intestinal and Pylorus Clamps	183
Pean Haemostatic Forceps	82-84,86
Haemostatic Forceps Atraumata	268
Kidney Clamps	86,200
Pederson Vaginal Speculums	211
Pedicle Clamps	201
Peet Splinter Forceps	66
Pelkmann Uterine Dressing Forceps	225
Pelvimeters	246
Pelvis Retractors	148
Pennington Forceps	70
Percy Amputation Retractors	320
Perforator	254
Perkins Retractors	153
Peripheral-Vascular Clamps	274-275
Percussion Hammers	1
Periosteum Knife	319
Peritoneum Forceps	91
Pertuiset Carotid Clamps	294
Phalangeal Knife	319
Phaneuf Hysterectomy Forceps	92
Piccolo Cotton Applicators	109
Pierce Antrum Trocars	208
Pinard Stethoscopes	2
Placenta and Ovum Curettes	243,252-254
Placenta Pan	427
Plaster Breakers	397
Instruments	393
Knives	393
Saw	393
Scissors	51,394
Shears	395,396
Spreaders	397
Plester Retractors	153
Suction Tube	402
Pliers For Bending and Cutting Wires	387
Pocket Instrument Set	112-113

Polyaethylen Splint Material	236
Polypus and Ovum Forceps	231,232
Pool Suction Tube	400
Post Mortem Knives	13
Potts-De Martel Gall Bladder Scissors	196
Potts-Smith Forceps	412
Needle Holders	412
Scissors	39,40,410
Powder Pot	427
Strewer	427
Pozzi Tenaculum Forceps	227
Pratt Organ Grasping Forceps	74
Rectal Specula	188
Pressure Clamps	94,184,193,276
Price Thomas Bronchus Forceps	295
Probes	106-109,385
Proctoscopes	189
Protection Caps (Steinmann Pins)	382
Providence-Hospital Delicate Forceps	79
Punches	310-312
Putti Bone File	341

Q

Quervain Bone Levers	324
Quinby Delicate Scissors	29

R

Rabiner Percussion Hammer	1
Ragnell Scissors Flat Point	26,410
Rampley Sponge Holding Forceps	70
Randall Endometrial Biopsy Curettes	237
Kidney Stone Forceps	203
Rankin Delicate Forceps	80
Raspatories	331-338
Rasps	339-341
Razors	22
Blade Holders	19
Recamier Ovum Curettes	243
Uterine Scoops	241
Rectal Scissors	46
Speculas	187-188
Reill Cutting Pliers	389
Drilling Chucks	383
Reposition Forceps	357
Replacement Lamps	10
Reposition Forceps	357,358
Resection Knives	14,319
Retractors	5,117,148,151-160,
For Cervical Spine	164-167,308
For Cervical Vertebral Column	159,164,167
For Deep Surgery	160
With Treangle Handles	134-135,144-145
119	
Reverdin Intestinal Spatula	150
Needles	102
Reynolds Dissecting Scissors	34
Rib Holding Forceps	297
Raspatories	298-299
Rongeurs	297
Shears	296
Spreaders	300-303,307
Ricard Abdominal Retractors	162
Richardson Retractors	132
Richardson-Eastman Retractors	132
Richter Vaginal Retractors	220
Ring Handle Bulldog Clamps	264,284
Robin Towel Clamps	76

Rochard Retractors	147
Rochester-Carmalt Haemostatic Forceps	86
Rochester-Ochsner Haemostatic Forceps	84
Rochester-Pean Haemostatic Forceps	83
Roeder Towel Clamps	75
Rohrschneider Needle Holder	96
Rollet Fine Wound Retractors	117
Rongeurs	313-318
Rose Retractors	123
Roser-Koenig Mouth Gag	6
Roettgen-Ruskin Bone Rongeurs	369
Round Bowls	426
Handle Needle Holders	97
Metal Boxes	425
Pliers	387
Roux Retractors	124
Rudd Haemorrhoidal Ligators	193
Rulers	11
Rumel Forceps	89
Rumel-Belmon Tourniquets	259
Ruskin Bone Rongeurs	369
Ruskin-Liston Bone Cutting Forceps	374
Russ-Modell Tissue Forceps	65
Rust Amputation Saws	321
Ryder Needle Holders	414
Ryder-Vascular Needle Holders	414

S

Saalfeld Knife	18
Saddle Hooks	119
Saenger Ovum Forceps	252,253
Safety Pins	76
Salenius Meniscus Knives	379
Salpingograph	260
Samii Tissue Grasping, Tumors Forceps	54
Sarot Needle Holders	414
Satinsky Anastomosis Clamps	293
Scissors	40
Satterlee Amputation Saws	322
Sauerbruch Retractors	129
Sterilizing Cases	428
Sauerbruch-Coryllos Rib Rongeurs	297
Saupe Cilia Forceps	66
Scalp Flap Forceps	251
Scalpel Handles	20,21
Knives	14,15,18
Scaphoid Gouges	351
Scapula Retractors	139,308
Schaaft Cilia Forceps	66
Schaedel Towel Clamps	75
Schede Bone Curettes	344
Scheinmann Biopsy Tip	240
Scherback Vaginal Speculums	219
Schimmelbusch Ether Mask	6
Sterilizing Drum	422
Schink Dermatomes	22
Schmid Irrigation Cannulae	257
Vascular Spatula	258
Schmieden Guiding Probes	106
Schmieden-Dick Ligature Needles	105
Schneider Pelvimeters	246
Raspatories	336
Schoemaker-Loth Needle Holder	100
Ligature Scissors	47
Schoenborn Retractors	122
Schroeder Organ Grasping Forceps	74
Tenaculum Forceps	227-229
Uterine Scoops	241
Schubert Biopsy Forceps	238

Schulz Bioptome	260	Spurling Rongeurs	314,316,317
Schulze Salpingograph	245	Sputum Cup	425
Schumacher Biopsy Forceps	239	St. Marks Retractors	148
Biopsy Tips	240	St. Martin Forceps	62
Bone Levers	329	Stacke Probes	109
Sternum Shears	296	Stamm Bone Cutting Forceps	373
Umbilical Cord Scissors	45,248	Standard Dissecting Forceps	57
Schumacher mod. Wagner Bone Levers	329	Scissors	30,31,405
Schwarz Traction Bows	382	Tissue Forceps	63
Scissors	23-51	Steinmann Pins	382
With Tungsten Carbide Inserts	405-411	Stellbrink Bone Rongeurs	365
Scoville-Richter Self-Retaining Retractors	158	Stelzner Rectal Scissors	46
Screw Driver	381	Sterilizing Baskets/Trays	431,432
Scudder Stomach Clamps	182	Cases	430
Sedillot Raspatories	336	Drums	422
Segond Myomatome	17,236	Forceps	55,424
Seidl DBP Biopsy Forceps	239	Sternal Puncture Needle	208
Vaginal Specula	211	Sternberg Cheek and Lip Retractor	5
Seiffert Probes	109	Retractors	123
Self Centering Forceps	363	Sternum Instruments	296
Self Retaining Retractors	151-156,158	Sternotomy Spreaders	304-305
Laminectomy Retractors	155-156	Stethoscopes	2
Sellers Rib Spreader and Contractor	307	Stevens Dissecting Scissors	26,33
Semb Bone Holding Forceps	297,360	Needle Holders	417
Bone Rongeurs	372	Stieglitz Splinter Forceps	66
Dissecting and Ligature Forceps	291	Stille Bone Rongeurs	370
Rib Raspatories	299,337	Chisels	353
Rib Rongeurs	297	Dissecting Scissors	37
Semken Delicate Forceps	56,62,411	Gouges	353
Semm Abdominal Retractors	166	Kidney Clamps	201
Vaginal Specula	210	Osteotomes	353,354
Senn-Miller Retractors	123	Plaster Shears	395,396
Sequestrum Forceps	359	Stille-Barraya Dissecting Forceps	170
Seutin Plaster Scissors	51,394	Stille-Ruskin Bone Rongeurs	370
Sewall Raspatories	332	Stomach Clamps	182
Seyffert Vaginal Specula	210	Storing Cases	422,429,430
Siebold Uterine Scissors	44	Strack Scissors	48
Sigmoid Anastomosis Forceps	185-186	Strainer for Tissues	244
Silicone Operating Pad	236	Stratte Needle Holders	414
Silver Dermatomes	22	Strassburger Tissue Forceps	65
Simon Bone Curettes/Scoops	241,346	Strassmann Elevating Forceps	234
Fistula Hooks	121	Strully Scissors	40
Retractors	121,135	Subramanian Aorta Clamps	280
Uterine Scoops	241	Suction Cannula	309,400,401,404
Wound Retractors	218	Curettes	244
Simplex Cheek and Lip Retractor	5	Handles	399
Simpson Obstetrics Forceps	250	Hose Connection	244
Uterine Probes	224	Instruments	309,398-404
Simpson-Braun Obstetrics Forceps	249,250	Raspatories	402
Sims Gynaecological Scissors	43,409	Tubes	309,400-404
Rectal Specula	187,188	Surgical Scissors	30-32,405
Uterine Curettes	242	Suture Hook	106
Uterine Probes	224	Instruments	102-104
Vaginal Specula	211	Scissors	411
Sims-Maier Sponge Forceps	69	Suture Instrument Sets	112
Sims-Siebold Uterine Scissors	44	Swab Holder	191
Skin Retractors	117	Swedish Pattern Forceps	58
Smellie Perforator	254	Syme Suture Needle	104
Smillie Meniscus Knives	379	Synovectomy Rongeurs	365
Smith Bandage Scissors	49	Sybert Bone Curettes With Hartpress Handle	347
Somer Elevating Forceps	234	Systrunk Nail Splitting Scissors	32,392
Spatulas	109		
Special Bone Levers	330		
Retractors	157		
Spencer Ligature Scissors	47		
Spencer-Wells Haemostatic Forceps	83		
Sphincteroscopes	189		
Splint Guide	236		
Splinter Forceps	66		
Sponge Forceps	67-71		
Holding Forceps	70-71		

T

Tablet Tray	425
Tager Special Bone Levers	330
Takahashi Rongeurs	313
Tampers	351
Tangential Occlusion Clamps	271-272
Taylor Percussion Hammer	1

Teale Tenaculum Forceps	229
Tendon Hooks	121
Interlacing Forceps	72
Seizing Forceps	72
Tenotomes	14-15
Tessier Bone Curettes	346
Thole Pelvimeter	246
Thoms-Gaylor Biopsy Forceps	238
Thoracic Retractors	306
Thorek Scissors	40
Thorpe Corneal Forceps	55
Thyroid and Vaginal Retractors	157,220
Tiemann Organ Grasping Forceps	74
Tissue Forceps	62-65
Grasping Forceps	54,70,71,73,74, 168,170,171
Tobold Tongue Depressor	5
Toennis Dissecting Scissors	34
Fine Wound Retractors	117
Needle Holders	100
Vascular Spatulas	258
Toennis Wire cutting Plier with T.C	421
Toennis-Adson Dissecting Scissors	34
Tongue Depressors	5
Forceps	6
Tourniquets	259
Tonsil Dissector	402
Forceps	86
Knives	17
Scissors	41
Towel Clamps	75,76
Townley Caliper	11
Trachea Retractors	118
Tracheal Dilators	256
Hooks	256
Tubes	255
Traction Bows	382
Hooks	380
Transformer	4
Transparent Suction Hose	244
Trays	426,430
Trelat Raspatories	331
Triangular Basins	427
Trigeminal Knife	17
Trocars	208,398,399
Troeltsch Forceps	61
Troemner Percussion Hammer	1
Trousseau Tracheal Dilators	256
Troutman-Chris Blade Holder	19
Tubal Seizing Forceps	236
Tubbs Aortic Dilators	260
Tuffier Intestinal Spatula	150
Rib Spreaders	300
Tissue Grasping Forceps	168
Tungsten Carbide Instruments	405-419
Tunnelling Instruments	261
Turnable Biopsy Forceps	190
Tuttle Lung Dissecting Forceps	65
Lung Grasping Forceps	290

U

Ueckermann-Denker Cryothyrotomy Trocar	255
Uffenorde Bone Curettes	343
Ultra-Light Forceps	59,172,262
Umbilical Cord Scissors	45,248
Universal Bandage Scissors	50
Handle	240
Trays	430
Trocars	208
Wire Cutting Scissors	48,388,411

Unna Extractor	18
Ureter Forceps	205
Urethral Bougies Urinary Instruments	206
Uterine Curettes	241,242
Depressor	224
Dilators	221,222
Dressing Forceps	225,226
Elevating Forceps	233-235
Flushing Tube	245
Probes	224
Scissors	43,44,409
Scoops	241
Secretion Scoop	237
Tenaculum Forceps	227-230
US-Army Retractors	124

V

Vacuum Curettes	244,398
Vaginal Clamps	93-94
Retractors	157,217,218,220
Speculas	209-219
Vaginal and Wound Retractors	218
Van Buren Bone Holding Forceps	359
Vannas Micro Spring Scissors	23,24
Vario Retractors	136,137,215
Vascular Dilators	257
Spatulas	258
Vein Retractors	122
Vena Cava Clamps	270,271,293
Venae Sectio Set	113-114
Verbrugge Bone Holding Forceps	363
Verbrugge-Muller Bone Levers	328
Vernier Caliper	11
Vessel Clamps	292
Hooks	115,116
Irrigation Cannulae	257
Scissors	39
Vidal Lupus Scraper	18
Virchow Knife	13
Vise Grip Pliers	387
Micro Forceps	52
Volkman Bone Curettes	342,344
Bone Retractors	125,126

W

Wachenfeldt Clip Applying Forceps	111
Wagener Vessel Hooks	115
Wagner Bone Levers	327
Mallets	349
Meniscus Knives	378
Raspatories With Hartpress Handle	338
Rongeurs	318
Walb Knife	13
Walter Gouges	353
Wangensteen Forceps	412
Intestinal Grasping Forceps	170
Needle Holders	99
Wartenberg Pinwheel	1
Waugh Tissue Forceps	64
Weber Aorta-Anastomosis Clamps	282
Webster Needle Holders	98
Wecker Eye Scissors	23
Weil-Blakesley Rongeurs	313
Weissbarth Vaginal Speculum	217
Weitlaner Self-Retaining Retractors	152-153
Weller Meniscus and Cartilage Forceps	377
Wertheim Anastomosis Clamps	275

Clamps and Forceps	92-95,201
Gynaecological Scissors	43
Hysterectomy Forceps	92
Parametrium Clamps	93
Wertheim-Cullen Clamps and Forceps	95
Wieder Tongue Depressor	5
Wiener Modell Suture Hooks	106
Wikstroem Dissecting and Ligature Forceps	291
Wilde Forceps	61
Willett Scalp Flap Forceps	251
Williams Intestinal Grasping Forceps	170
Lung Grasping Forceps	290
Williger Bone Curettes	342,344
Elevators	324
Raspatories	331
Retractors	120
Winter Ovum Forceps	252
Wire Catcher	385
Cutters	388
Cutting Pliers	387,389,391,421
Cutting Scissors	48,388,411
Extentions	380,381
Guides	384
Holding Forceps	386,387
Saws	323
Tightener	380,383,385
Tightening Pliers	386
Traction Bow	380,381
Twister	385
Winkelmann Circumcision Clamps	207
Wolff Plaster Breakers	397
Wound Retractors	117-118,122
Wound and Tracheal Hooks	256
Wrenches	380
Wrigley Obstetrics Forceps	250
Wullstein Self-Retaining Retractors	153
Suction Tube	403

Y

Yankauer Suction Cannulae	309,401
Yasargil Ligature Forceps	53,87
Micro Forceps	53
Micro Needle Holders	96,97,420
Micro Scissors Bayonet Shape	25
Rongeurs	317
Suction Cannulae	309,403,404
Tumor & Vessel Forceps	54

Z

Zenker Forceps	89
Retractor	139
Ziegler Head band	3
Head Mirror	3
Millium Knives	18
Zielke Gouges	335



CONTACT US

Address: FFM9+HX, Ugoke, Sialkot, Punjab 51310

Phone: +92- 304 8000543

E-mail: Info@medicrestsurgical.com

Website: www.medicrestsurgical.com