



CATALOGUE

DENTAL INSTRUMENTS

Serving Your Health With Excellence



We Present this Catalogue with the aim of long life commitment and missionary dedication brought the Company, we acquired unblemished of reputation as manufacturers of complete range of Dental Instruments as per standard set by international medical and surgical organizations.

We have come to specialize in instruments concerning Dental Surgery or The two vital factors that can darken or illuminate the world of a patient are the dexterity of the surgeon's hands & the precision of the instruments involved. As for as the accuracy of the instruments is concerned, we perform our part as conscientiously as is possible by the combination of human hands and the latest available technology.

Service to humanity comes first on our agenda, business and profit is the second.

From the procurement of raw materials to packing, all the phases of the process are conducted under the same roof. This ensures and facilitates Our interference at any stage of the process, which makes it possible for us to achieve perfection. Our technical experts can achieve any degree of technicality, ranging from the slightest variations to complete redesigning and production of entirely new items.

The quality of raw materials is of the international standard, but we can also satisfy individual specifications selecting from a large variety of imported Steel.

We also welcome enquires for the instruments not listed in this catalogue both in the Dental Instruments.

DESCRIPTION	PAGE #
SCALPELS	2-6
SCISSORS	8-18
DRESSING FORCEPS	20-31
HEMOSTATIC FORCEPS	34-38
ROOT ELEVATORS	40-46
EXTRACTING FORCEPS	48-70
RETRACTORS	72-78
SUTURES, SUCTION TUBES & MEASURING TOOLS	80-91
DENTAL MIRRORS & SYRINGES	94-98
EXPLORERS	100-175
MALLETS, BONE RONGERS & MOUTH GAGS	178-198
PLIERS	200-210
ARTICULAR & IMPRESSION TRAYS	212-222
STERILIZING BOXES	224-230



Scalpel

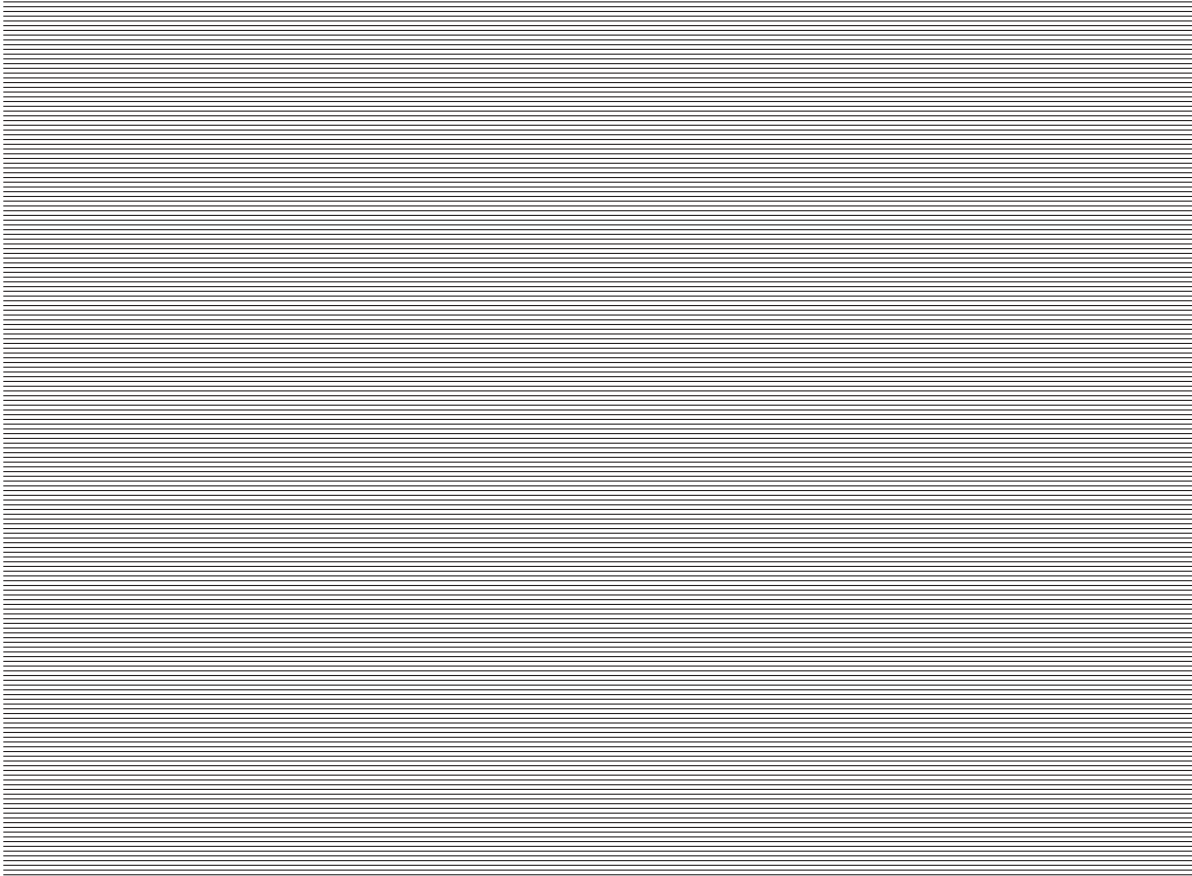

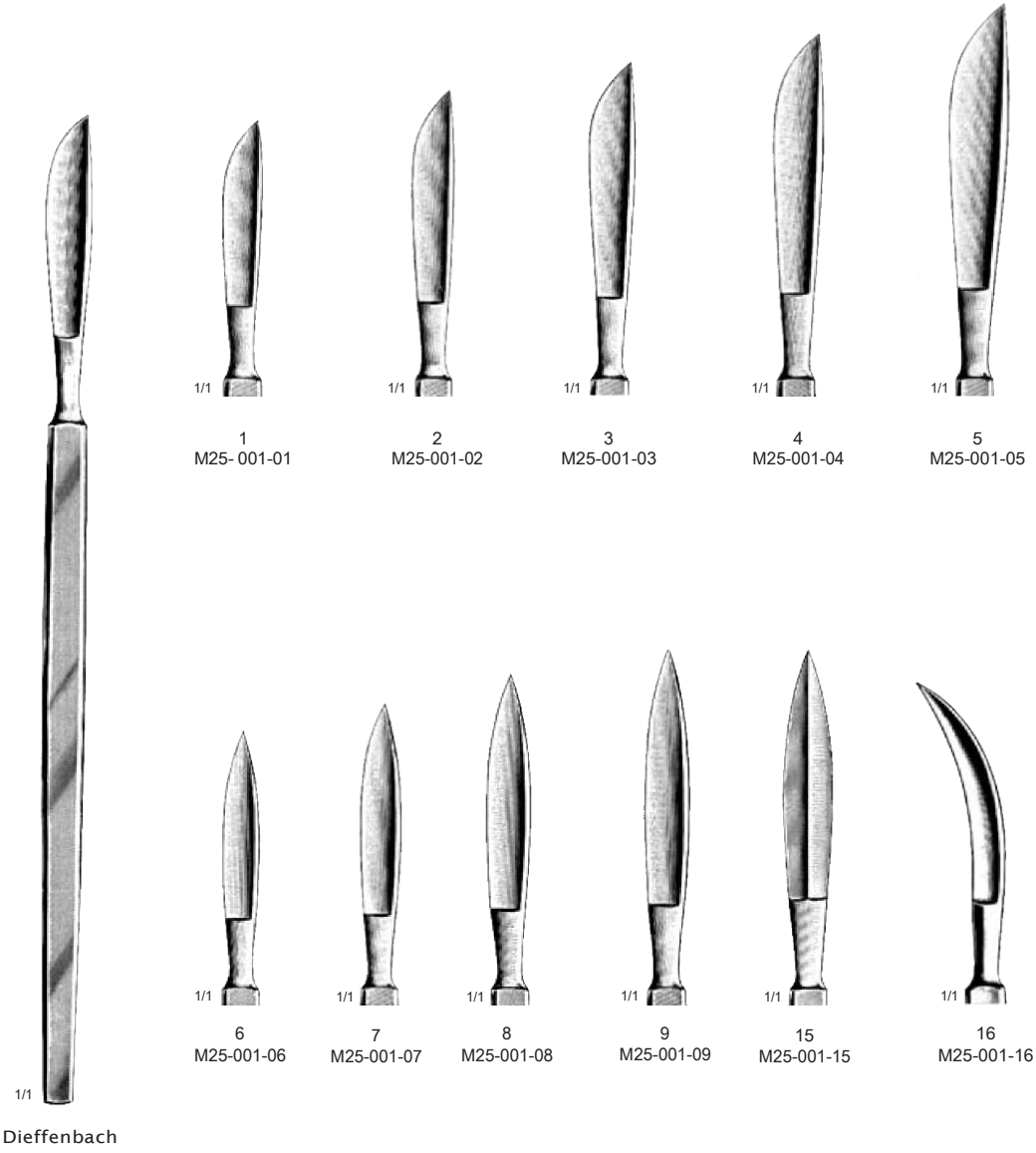

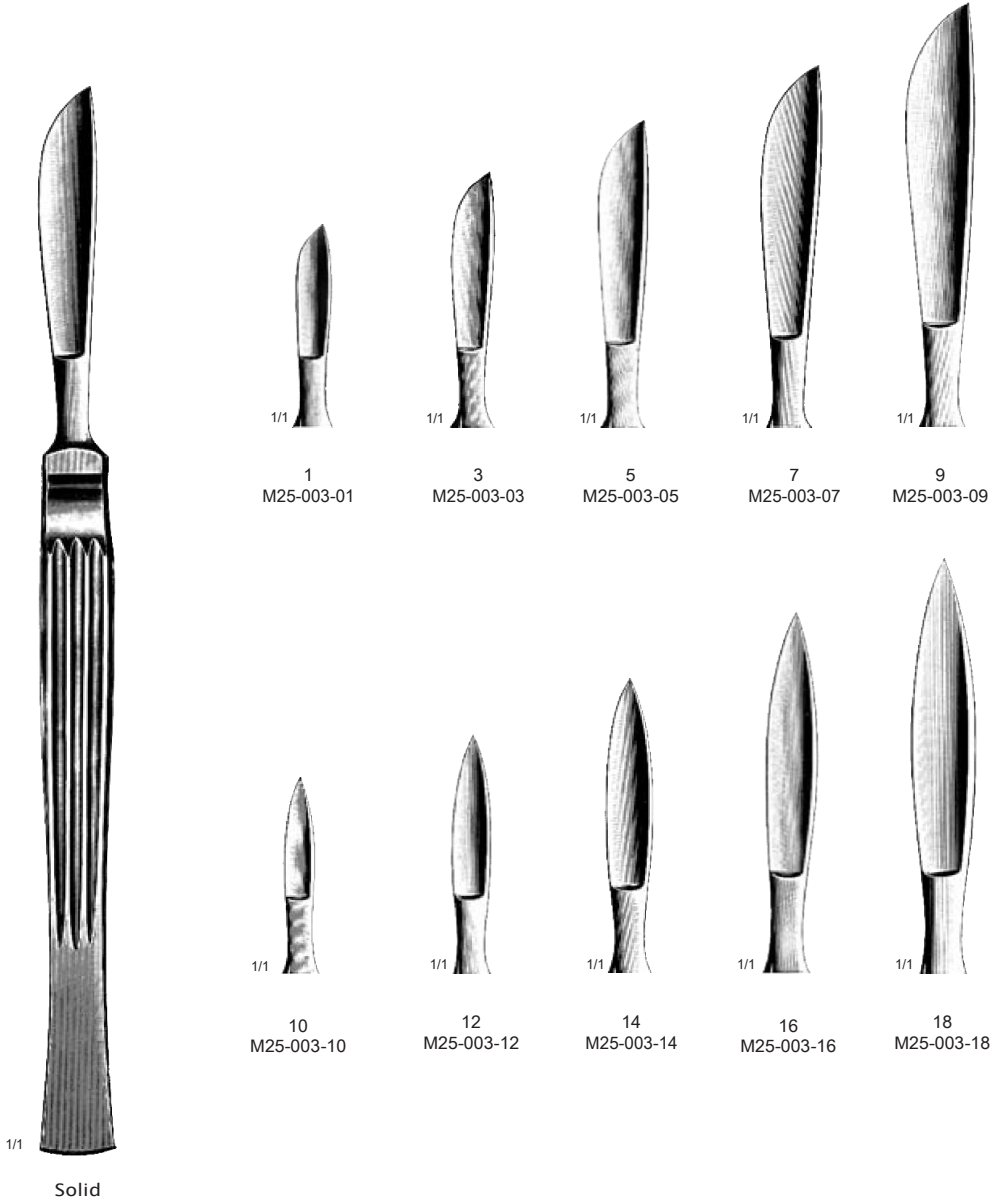

M25-003-01 M25-003-64 Knives with Solid Handle

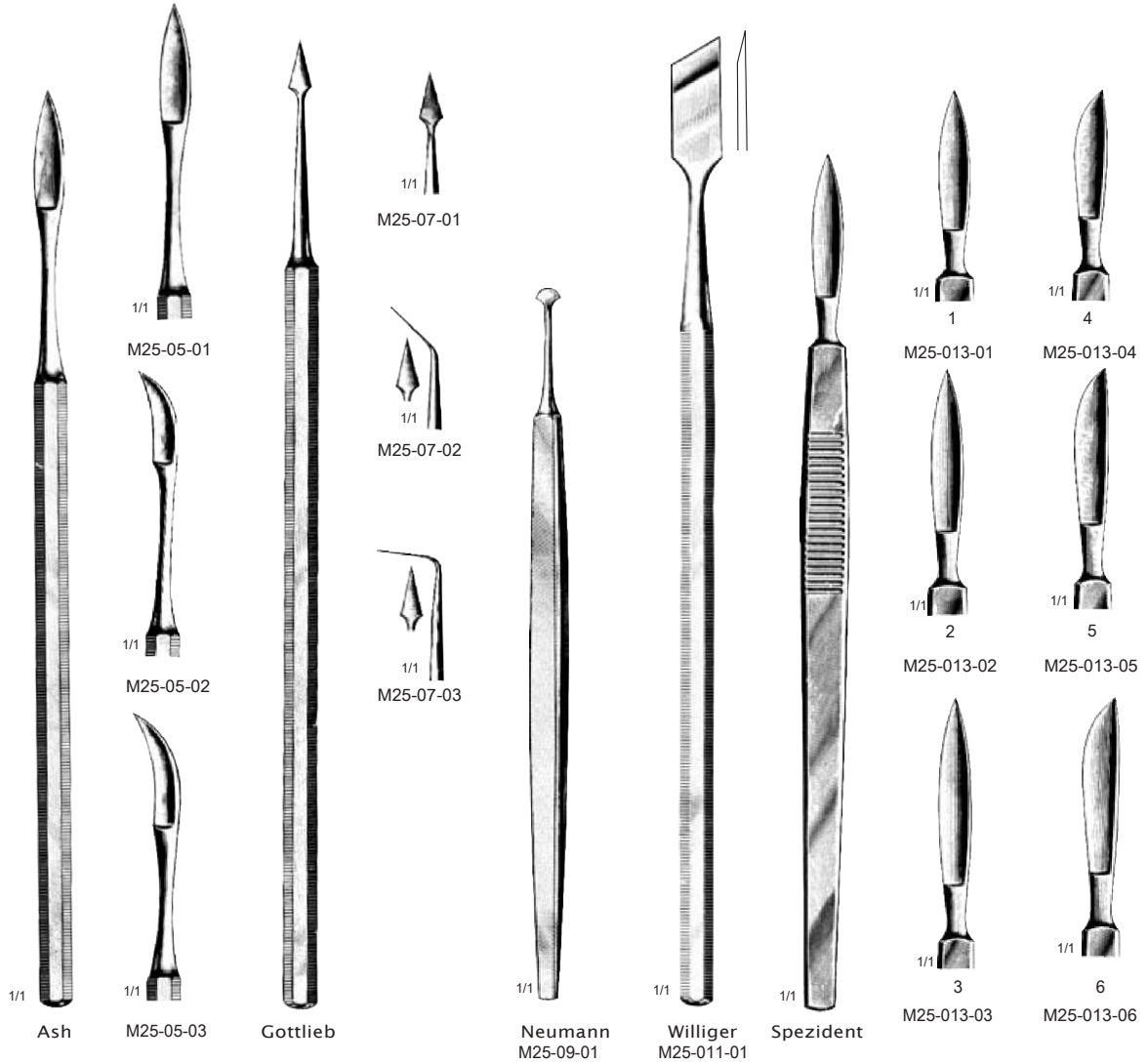

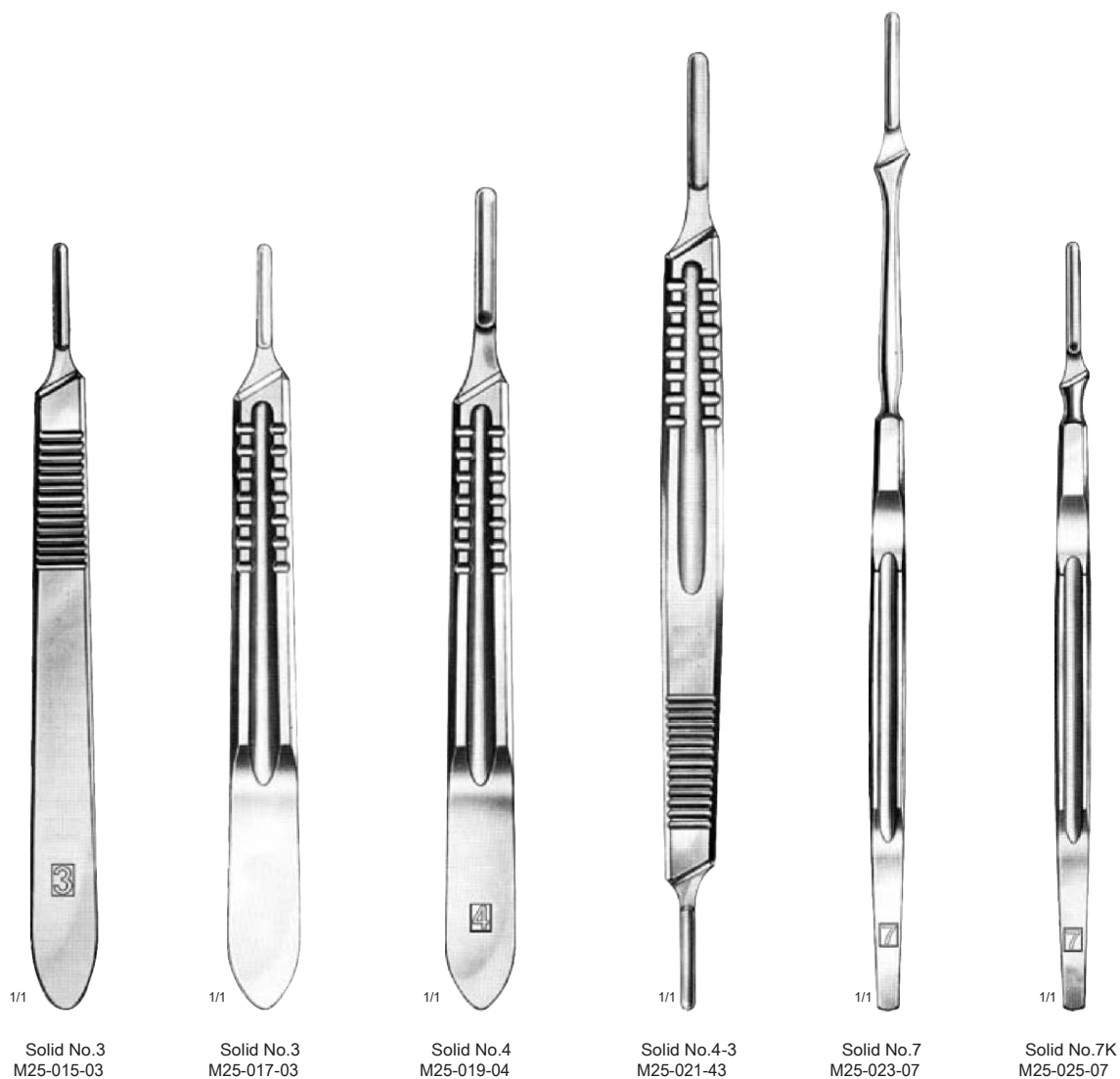

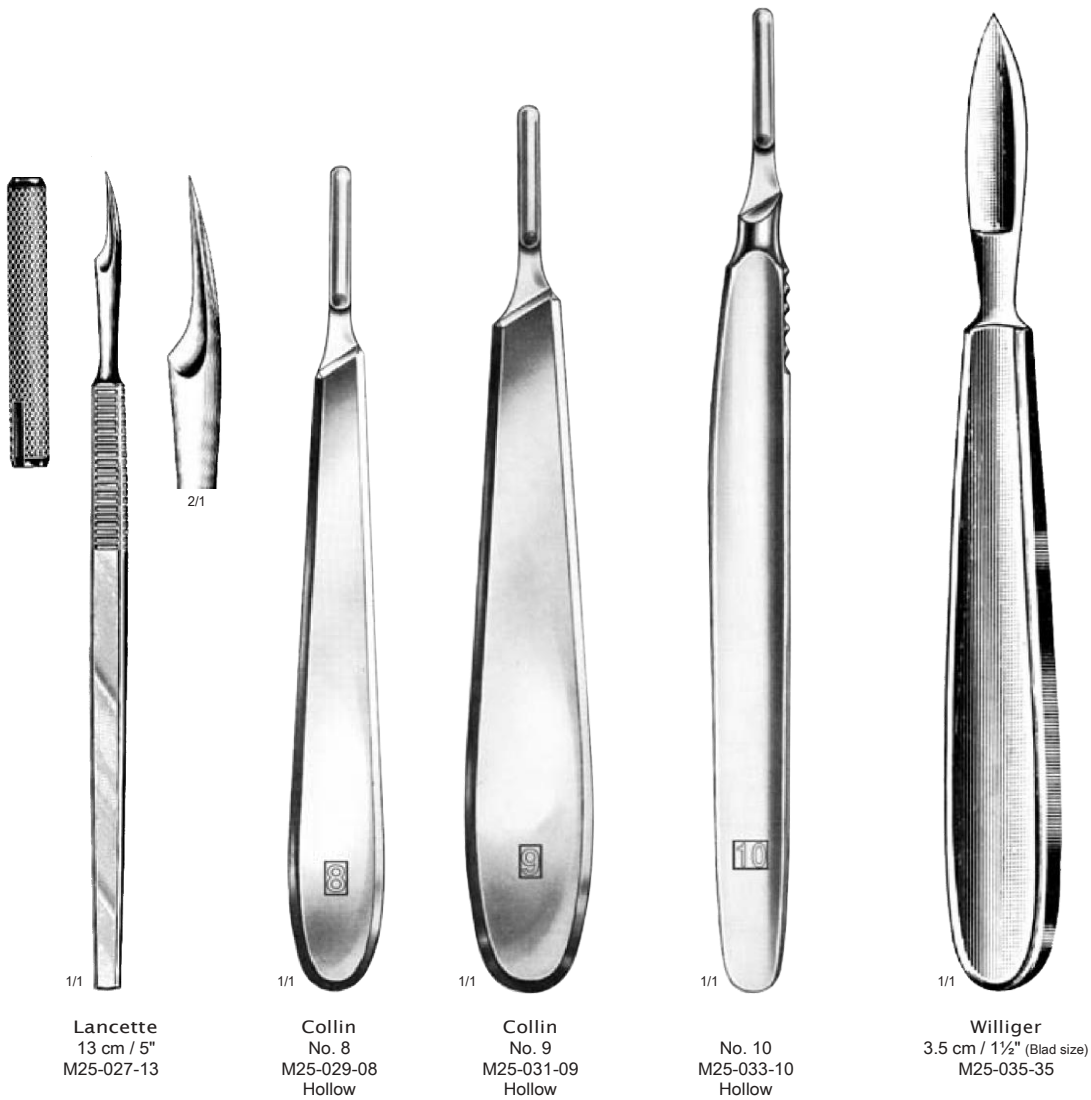



Scissors

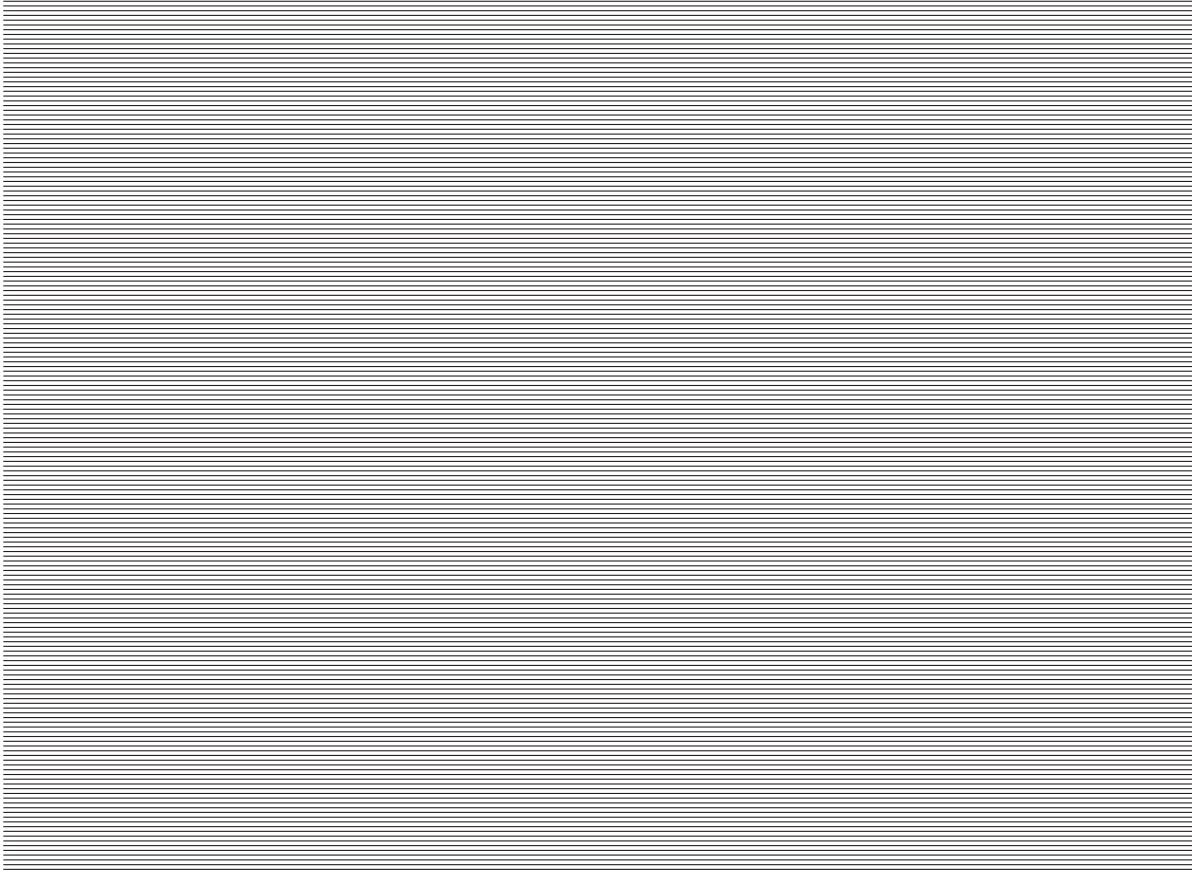

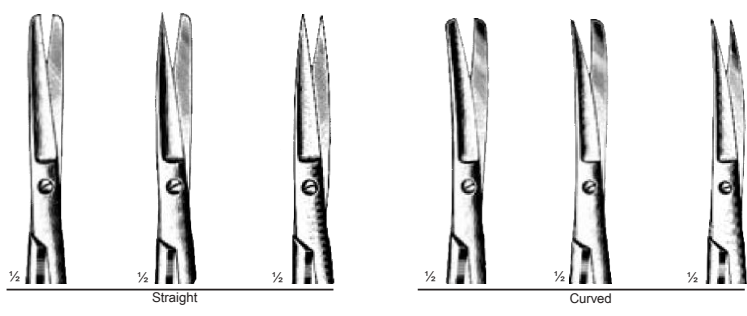

cm	in						
10.5	4 1/4	M26-001-10	M26-003-10	M26-005-10	M26-007-10	M26-009-10	M26-011-10
11.5	4 1/2	M26-001-11	M26-003-11	M26-005-11	M26-007-11	M26-009-11	M26-011-11
13	5	M26-001-13	M26-003-13	M26-005-13	M26-007-13	M26-009-13	M26-011-13
14.5	5 1/2	M26-001-14	M26-003-14	M26-005-14	M26-007-14	M26-009-14	M26-011-14
15.5	6	M26-001-15	M26-003-15	M26-005-15	M26-007-15	M26-009-15	M26-011-15
16.5	6 1/2	M26-001-16	M26-003-16	M26-005-16	M26-007-16	M26-009-16	M26-011-16

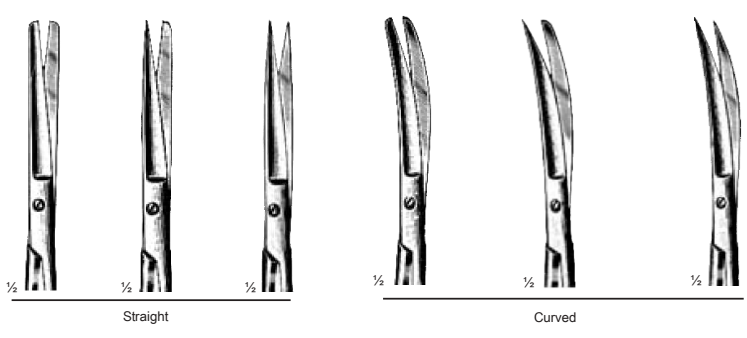

cm	in						
13	5	M26-013-13	M26-015-13	M26-017-13	M26-019-13	M26-021-13	M26-023-13
14.5	5 1/2	M26-013-14	M26-015-14	M26-017-14	M26-019-14	M26-021-14	M26-023-14



Metzenbaum
14.5 cm / 5 1/2"

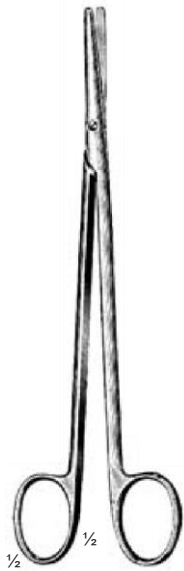
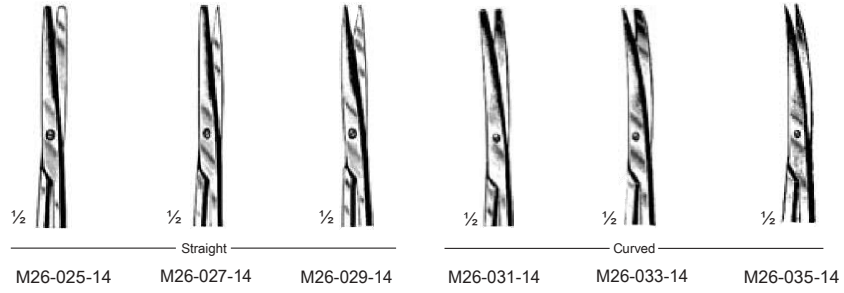

Metzenbaum-Nelson
18 cm / 7"

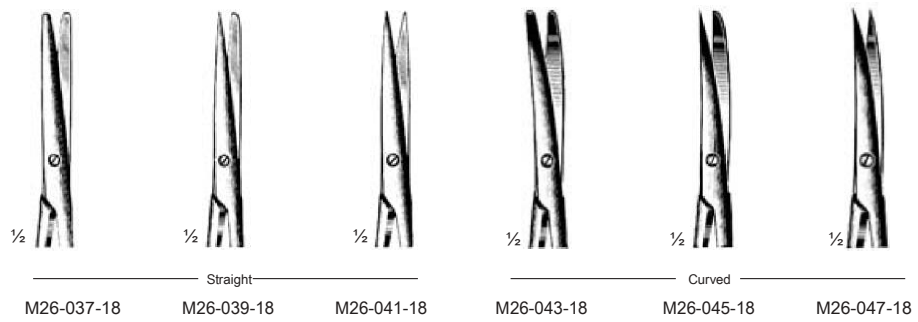

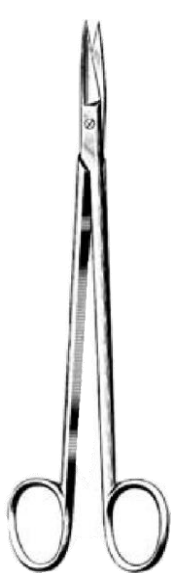

Kelly
16 cm / 6½"
M26-049-16

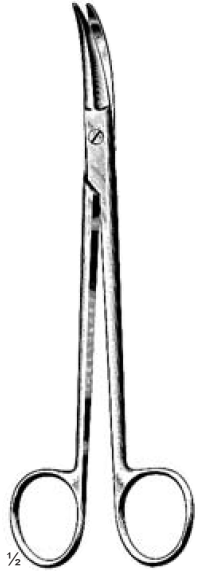

Prince
18 cm / 7"
AE 02-051-18

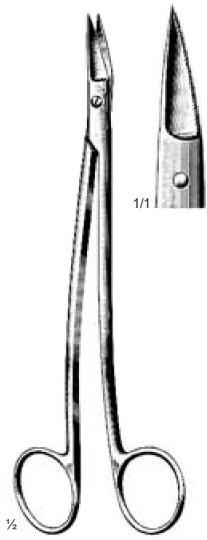

Dean
17 cm / 6¾"
M26-053-17

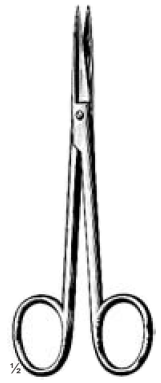

12 cm / 4¾"



M26-055-12



M26-057-12



M26-059-12



M26-061-12

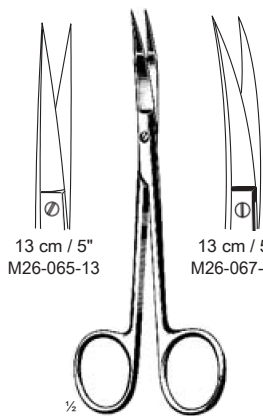

13 cm / 5"
M26-065-13

Wagner
13 cm / 5"

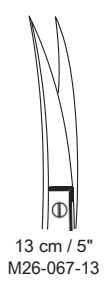

13 cm / 5"
M26-067-13

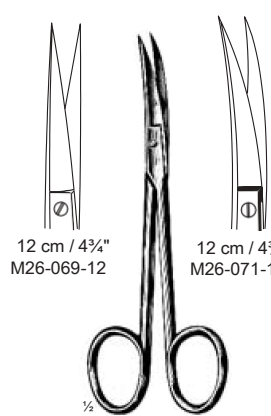

12 cm / 4¾"
M26-069-12

Wagner
12 cm / 4¾"

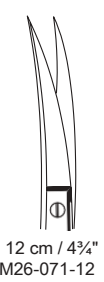

12 cm / 4¾"
M26-071-12

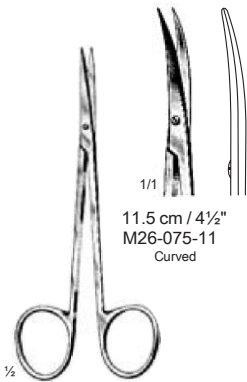

11.5 cm / 4½"
M26-075-11
Curved

11.5 cm / 4½"
M26-073-11
Straight

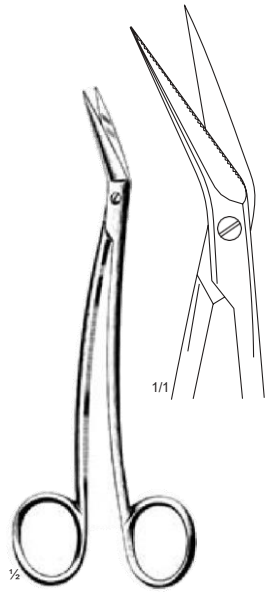

Locklin
16 cm / 6¼"
M26-077-16
Saw edge

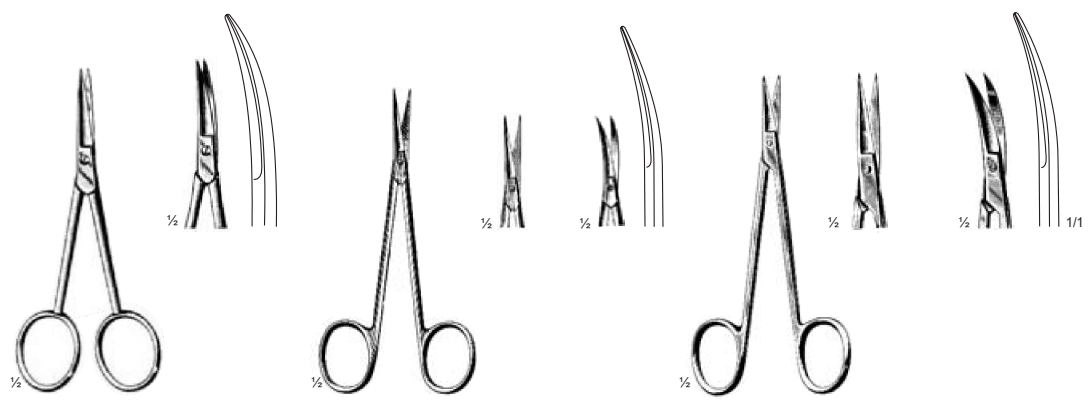

cm	in	Straight	Curved	Straight	Curved	Straight	Curved
9	3½			M26-083-09	M26-085-09		
10	4			M26-083-10	M26-085-10		
11	4½	M26-079-11	M26-081-11	M26-083-11	M26-085-11	M26-087-11	M26-089-11
11.5	4½						

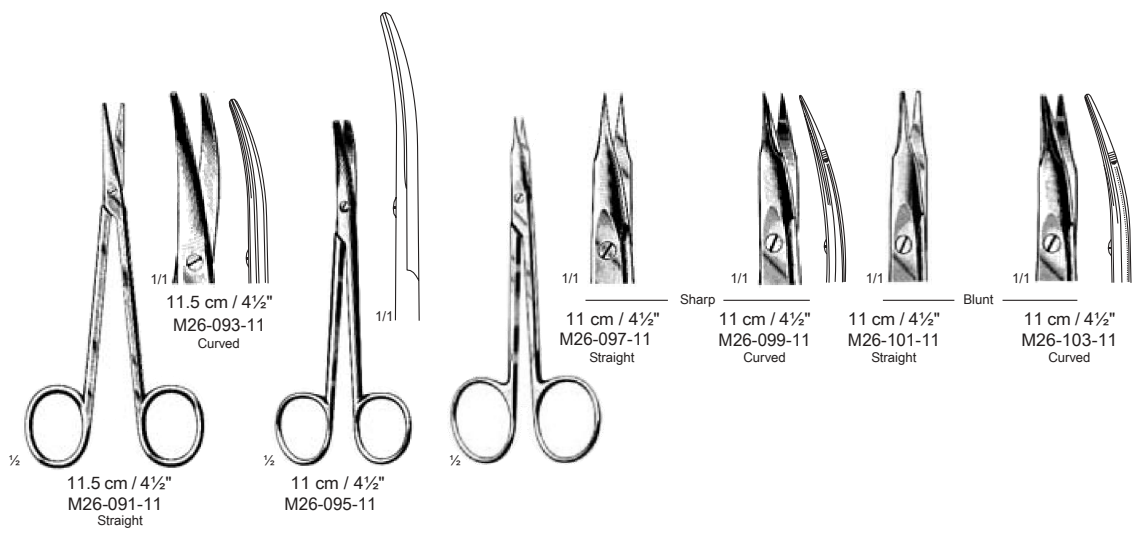

M26-083-09 M26-089-11 Iris Scissors



13 cm / 5"
M26-105-13

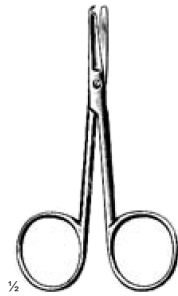

Spencer
9 cm / 3½"
M26-107-09

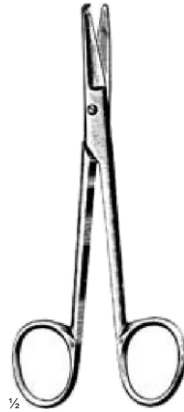

Spencer
13 cm / 5"
M26-109-13



Buck
14.5 cm / 5½"
M26-111-14
18 cm / 7"
M26-111-18



12 cm / 4¾"
M26-113-12



Littauer
14 cm / 5½"
M26-115-14

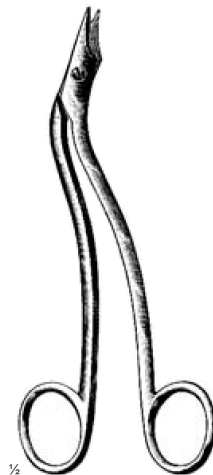

Heath
15 cm / 6"
M26-117-15



Shoemaker-Loth
13 cm / 5"
M26-119-13



Eiselsberg
12 cm / 4¾"
M26-121-12

M26-105-13 M26-121-12 Ligature Scissors



Universal
12 cm / 4 3/4"
M26-123-12
Saw edge

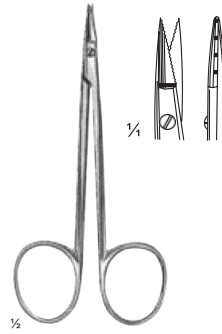

10 cm / 4"
M26-125-10
Saw edge

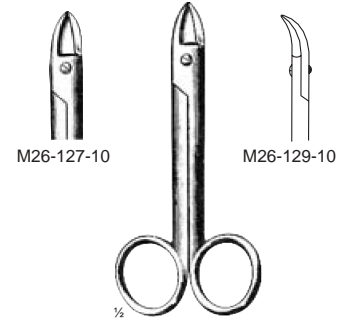

Beebe
10 cm / 4"
Blunt

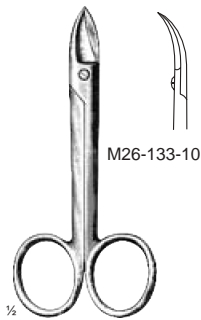

Beebe
10 cm / 4"
M26-131-10
Sharp

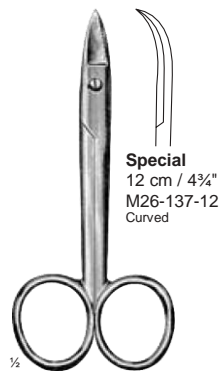

Special
12 cm / 4 3/4"
M26-137-12
Curved

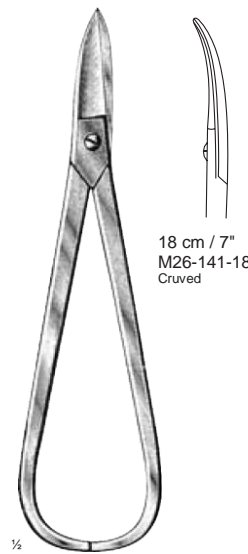

18 cm / 7"
M26-139-18
Straight

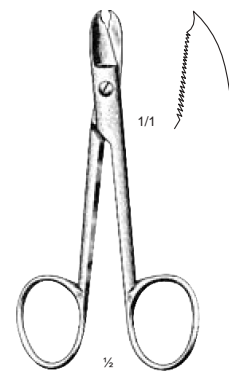

12 cm / 4 3/4"
M26-143-12
Saw edge



10.5 cm / 4"
M26-145-10
Saw edge

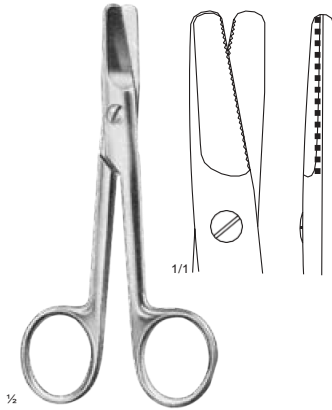

Harvey
12.5 cm / 5"
M26-147-12

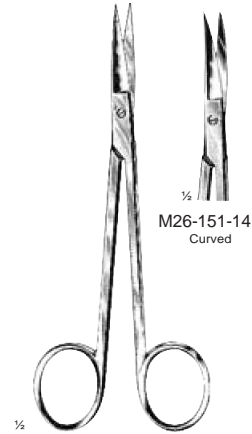

Sanvenero
14 cm / 5½"
M26-149-14
Straight

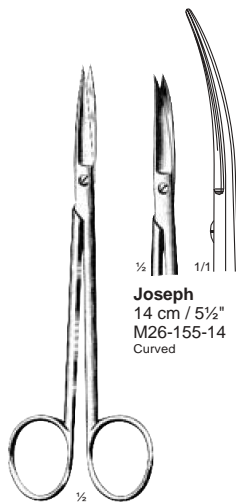

Joseph
14 cm / 5½"
M26-155-14
Curved

Joseph
14 cm / 5½"
M26-153-14
Straight

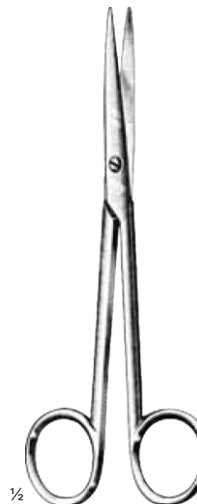

Lexer
16cm/6 ¼"
M26-157-16
21cm/8 ½"
M26-159-21

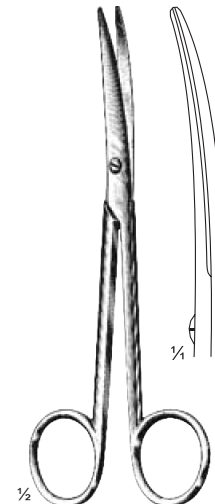

Lexer
16cm/6 ¼"
M26-161-16
21cm/8 ½"
M26-163-21



Metzenbaum
14.5 cm / 5½"
M26-165-14
saw edge, straight



Metzenbaum
14.5 cm / 5½"
M26-167-14
saw edge, curved

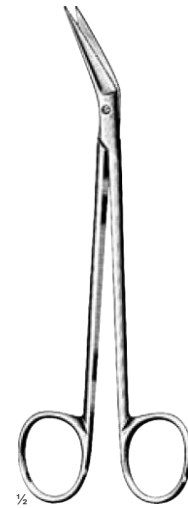

Locklin
16 cm / 6¼"
M26-173-16
saw edge

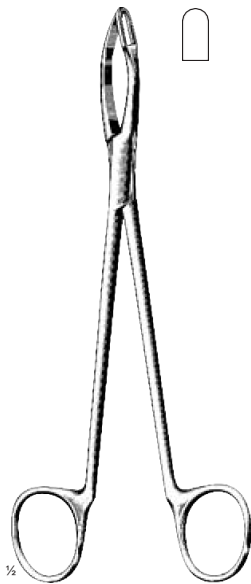

Modell USA
18 cm / 7"
M26-175-18

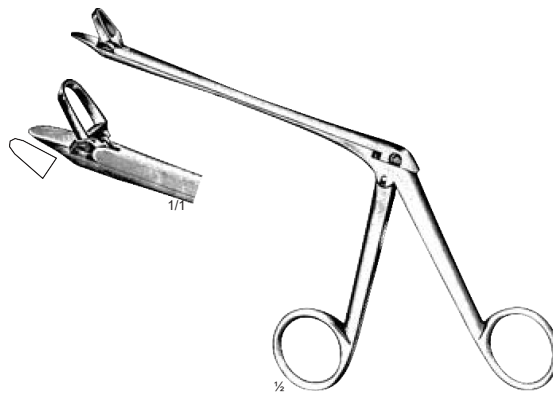

Tomati
19 cm / 7½"
M26-177-19



10 cm / 4"
M26-179-10

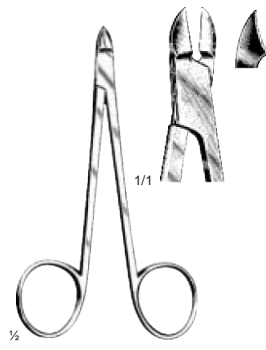

10.5 cm / 4 1/4"
M26-181-10

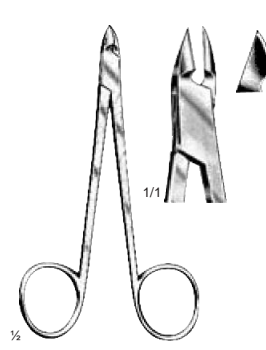

10.5 cm / 4 1/4"
M26-183-10

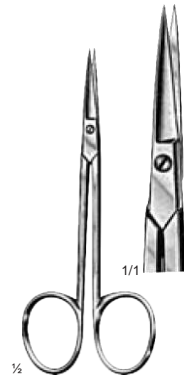

10 cm / 4"
M26-185-10

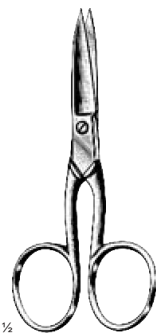

9 cm / 3 1/2" M26-187-09
10 cm / 4" M26-187-10
11 cm / 4 1/2" M26-187-11

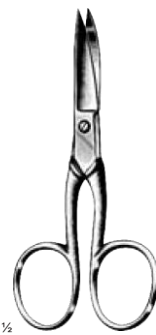

9 cm / 3 1/2" M26-189-09
10 cm / 4" M26-189-10
11 cm / 4 1/2" M26-189-11

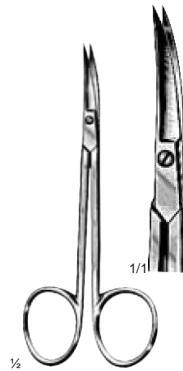

10 cm / 4" M26-191-10
11 cm / 4 1/2" M26-191-11

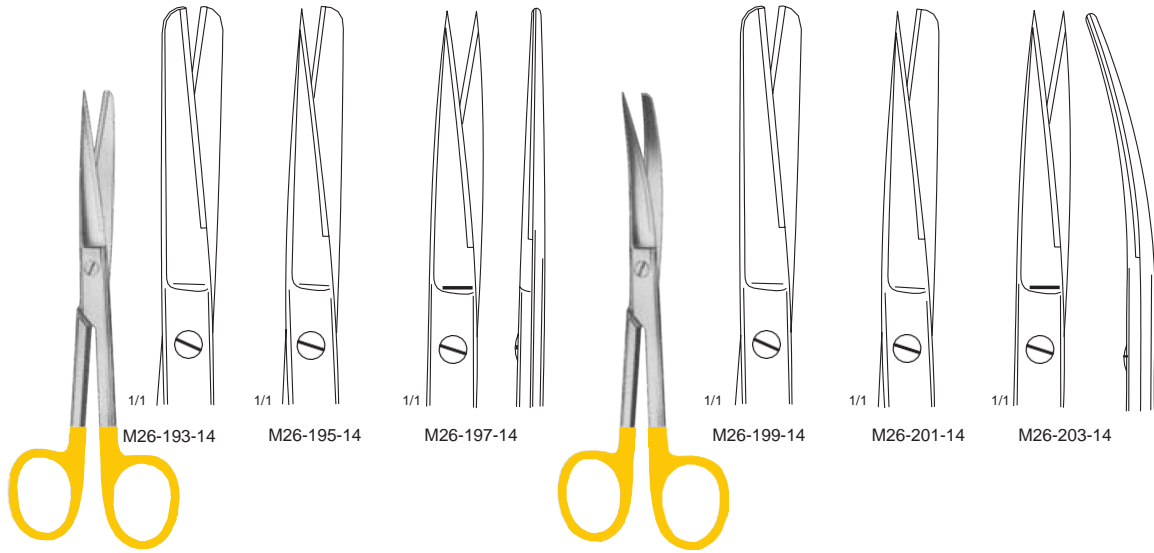

Standard
14 cm / 5½"

Standard
14 cm / 5½"

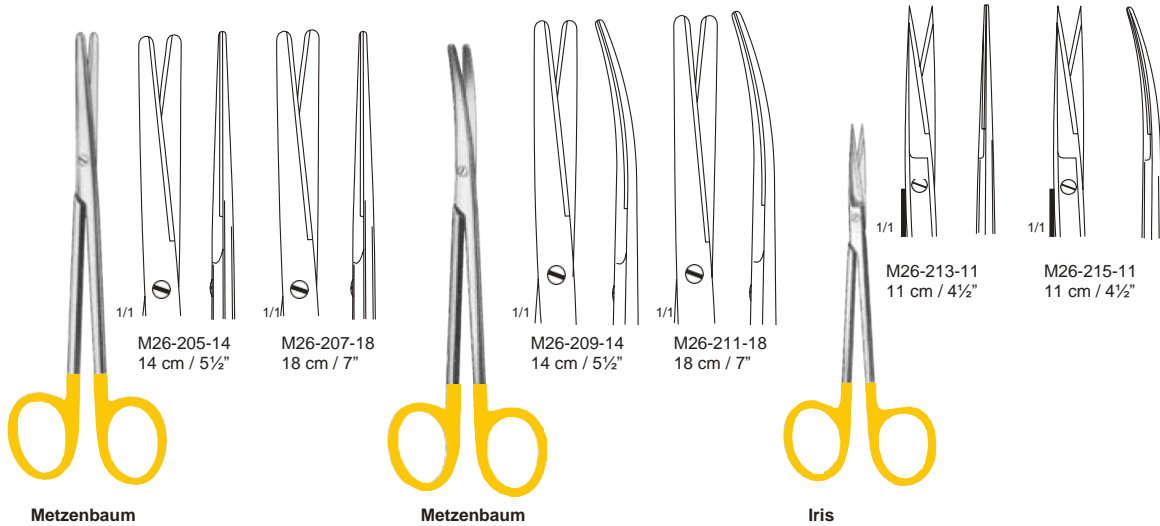

Metzenbaum

Metzenbaum

Iris

Scissors with tungsten carbide inserts

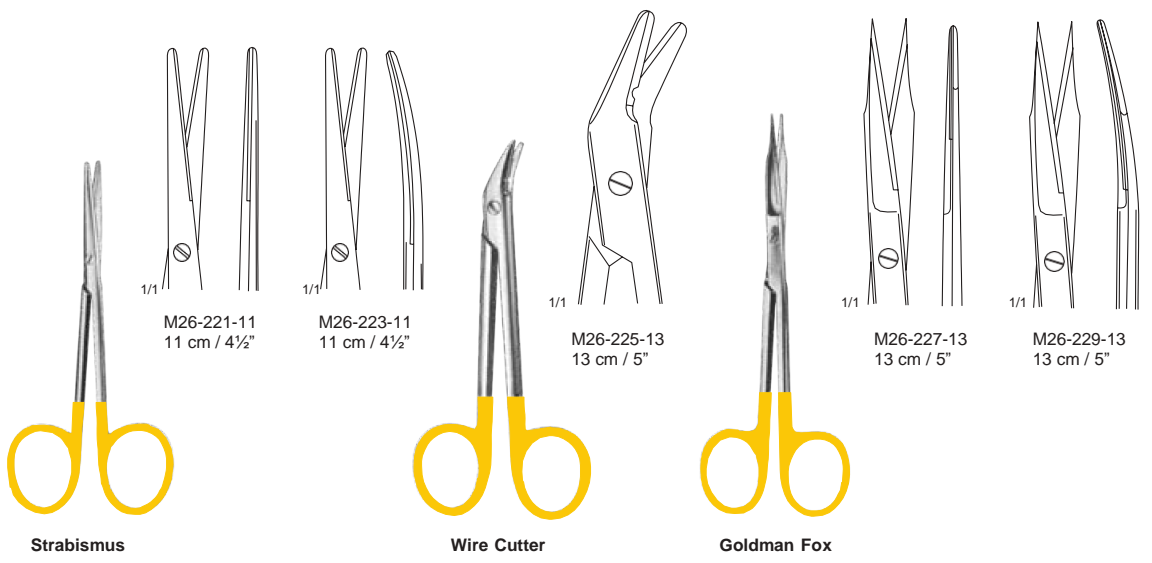



3

Dressing Forceps





cm	in.	Standard	Standard	Standard	Standard	USA. Mod.	USA. Mod.
10.5	4¼	M27-001-10	M27-003-10	M27-005-10	M27-007-10	M27-009-14	M27-011-14
14.5	5½	M27-001-14	M27-003-14	M27-005-14	M27-007-14	M27-009-14	M27-011-14
16	6½	M27-001-16	M27-003-16	M27-005-16	M27-007-16	M27-009-18	M27-011-18
18	7	M27-001-18	M27-003-18	M27-005-18	M27-007-18	M27-009-18	M27-011-18

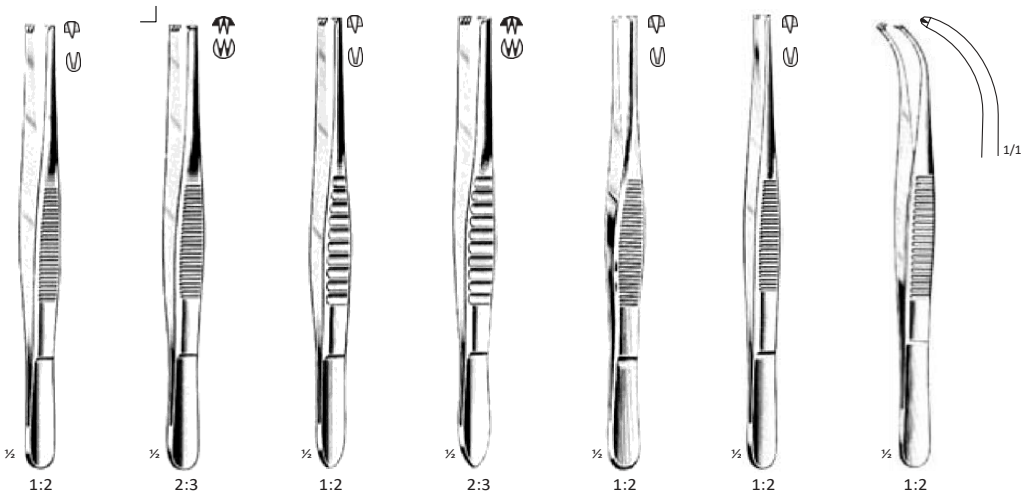

cm	in.	1:2	2:3	1:2	2:3	1:2	1:2	1:2
11	4¼	M27-013-11	M27-015-11	M27-017-14	M27-019-14	M27-021-14	M27-023-14	M27-025-14
14	6	M27-013-14	M27-015-14	M27-017-14	M27-019-14	M27-021-14	M27-023-14	M27-025-14
16	7	M27-013-16	M27-015-16	M27-017-18	M27-019-18			
18	8	M27-013-18	M27-015-18	M27-017-18	M27-019-18			

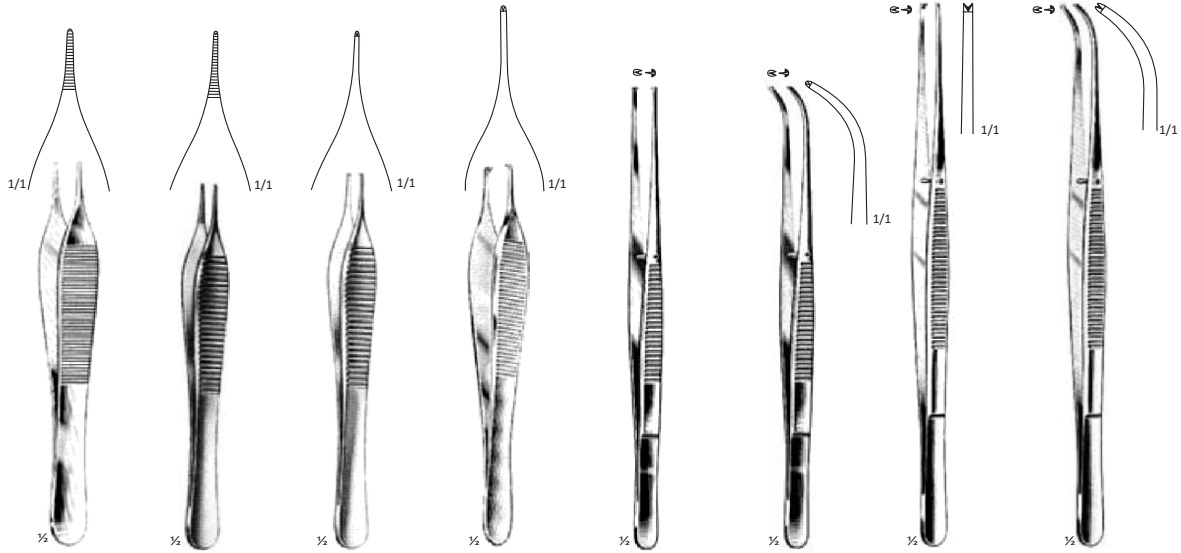

Adson 12 cm / 4 3/4" M27-026-12	Micro-Adson 12 cm / 4 3/4" M27-027-12	Micro-Adson 12 cm / 4 3/4" M27-029-12 1:2	Adson 12 cm / 4 3/4" M27-031-12 15 cm / 6" M27-031-15 1:2	Semken 12.5 cm / 5" M27-033-12 15 cm / 6" M27-033-15 1:2	Semken 12.5 cm / 5" M27-035-12 15 cm / 6" M27-035-15 1:2	Taylor 17.5 cm / 7" M27-037-17 1:2	Taylor 17.5 cm / 7" M27-039-17 1:2
--	--	---	---	--	--	--	--

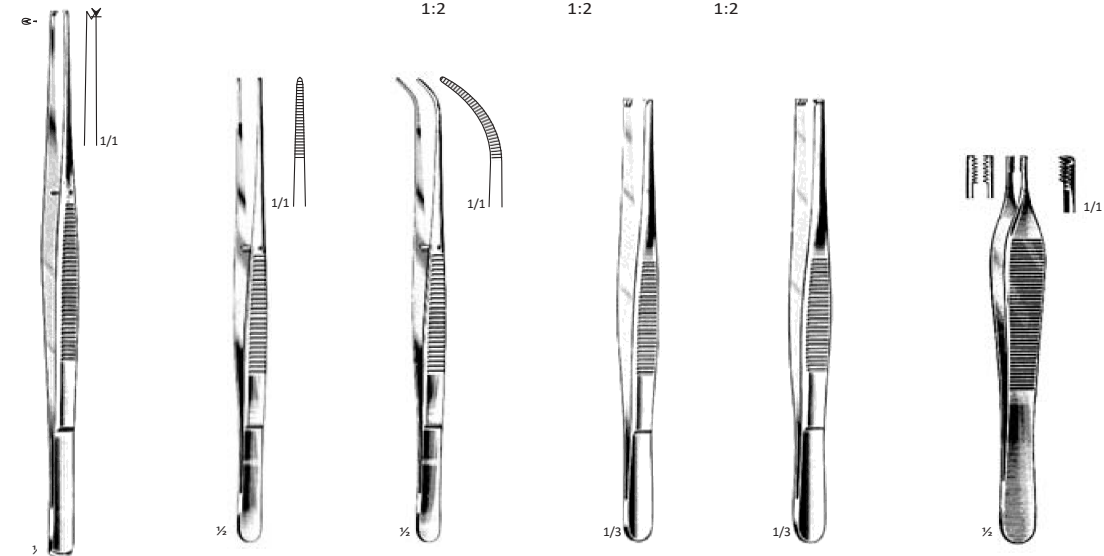

Taylor 17.5 cm / 7" M27-041-17 1:2	Semken 12.5 cm / 5" M27-043-12 15.5 cm / 6" M27-043-15	Semken 12.5 cm / 5" M27-045-12 15.5 cm / 6" M27-045-15	Potts-smith 18 cm / 7" M27-047-18 21 cm / 8 1/4" M27-047-21	Potts-smith 18 cm / 7" M27-049-18 21 cm / 8 1/4" M27-049-21	Adson-Brown 12 cm / 4 3/4" M27-051-12
--	---	---	--	--	--

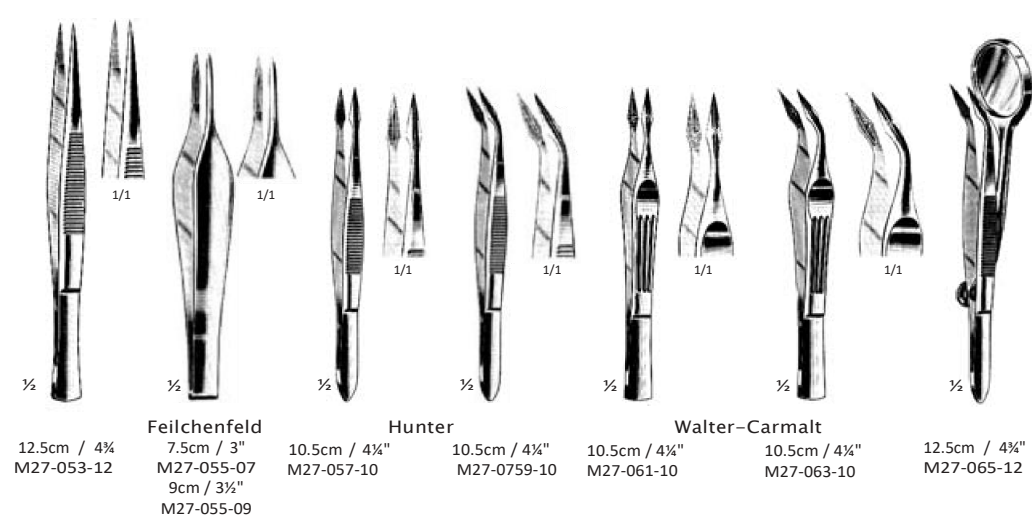
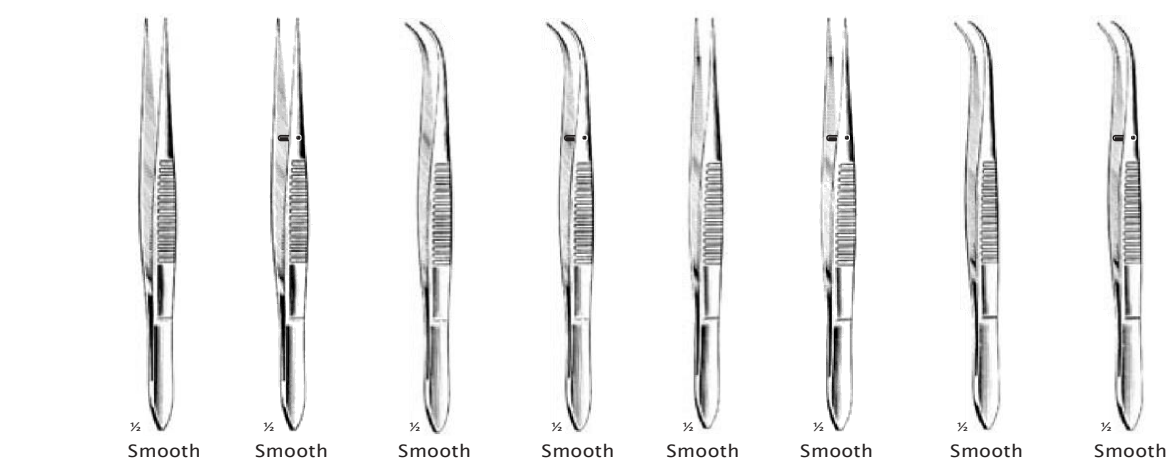
cm	in								
8	3¼	M27-067-08	M27-069-08	M27-071-08	M27-073-08	M27-075-08	M27-077-08	M27-079-08	M27-081-08
9	3½	M27-067-09	M27-069-09	M27-071-09	M27-073-09	M27-075-09	M27-077-09	M27-079-09	M27-081-09
10.5	4¼	M27-067-10	M27-069-10	M27-071-10	M27-073-10	M27-075-11	M27-077-10	M27-079-10	M27-081-10
11.5	4½	M27-067-11	M27-069-11	M27-071-11	M27-073-11	M27-075-12	M27-077-11	M27-079-11	M27-081-11
12.5	5	M27-067-12	M27-069-12	M27-071-12	M27-073-12		M27-077-12	M27-079-12	M27-081-12



2/3

London Collage
15 cm / 6"



1/1



1/1



1/1

1
M27-083-01

2
M27-083-02

3
M27-083-03



1/1



1/1



1/1



1/1

4
M27-085-04

5
M27-085-05

6
M27-085-06

7
M27-085-07



2/3

London Collage
15 cm / 6"

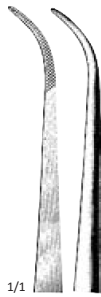

1/1



1/1



1/1



1/1

1
M27-087-01

2
M27-087-02

3
M27-087-03

4
M27-087-04



1/1

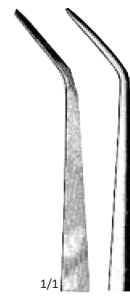

1/1



1/1

5
M27-089-05

6
M27-089-06

7
M27-089-07

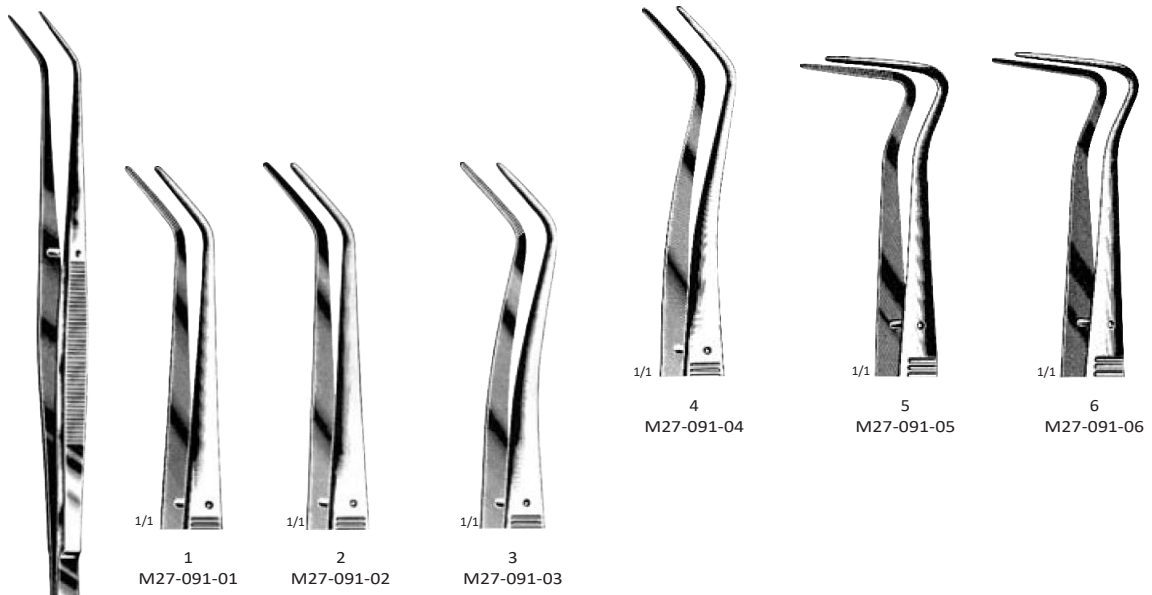

2/3
Flagg
15 cm / 6"

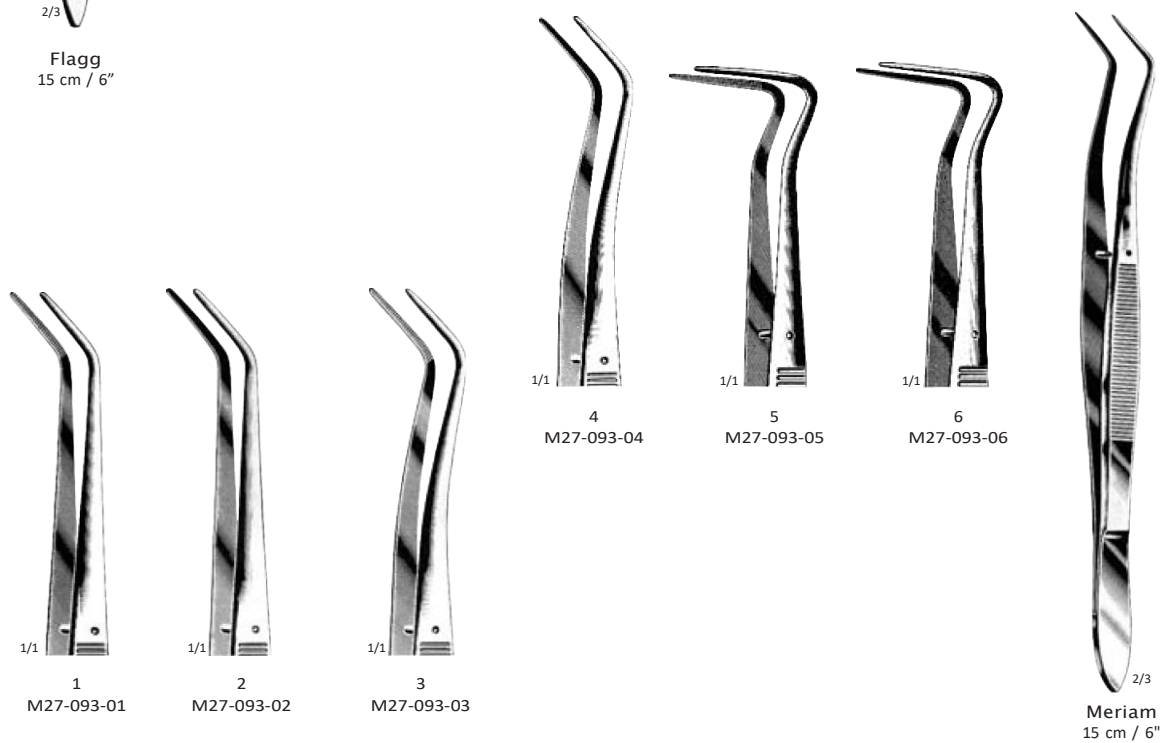



Landgraf
15 cm / 6"



1/1
1
M27-095-01

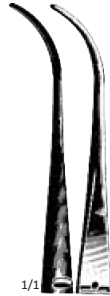

1/1
2
M27-095-02



1/1
3
M27-095-03

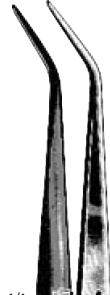

1/1
4
M27-095-04



2/3
Perry
12.5 cm / 5"
M27-097-12



1/1



2/3
Perry
12.5 cm / 5"
M27-099-12

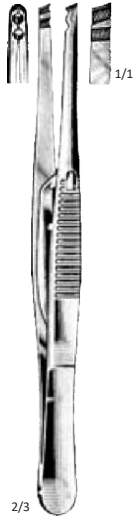

2/3
Zeibe
12.5 cm / 5"
M27-101-12



1/2
Mod Martin
Suture & Membrane Forceps

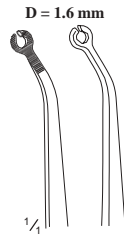

1/4
16cm / 6 1/4"
M27-103-16

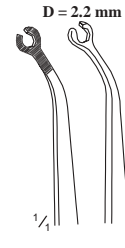

1/4
16cm / 6 1/4"
M27-105-16



1/2
Mod Martin
Suture & Membrane Forceps



$\frac{2}{3}$
13.5cm/5 $\frac{1}{4}$ "
M27-109-01



$\frac{2}{3}$
13.5cm/5 $\frac{1}{4}$ "
M27-111-01



$\frac{2}{3}$
14cm/5 $\frac{1}{2}$ "
M27-113-01



Brom-Allen
16.5 cm/6 $\frac{1}{2}$ "
M27-115-16

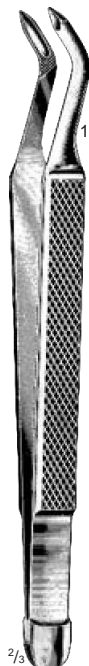

Albrecht
16 cm/6 $\frac{1}{4}$ "
M27-117-16



Albrecht
16 cm/6 $\frac{1}{4}$ "
M27-119-16



$\frac{1}{1}$
Miller
15 cm / 6"
M27-121-16
Practicing Paper
Forceps



2/3
16cm/6 ¼"
M27-123-16



2/3
16cm/6 ¼"
M27-125-16



2/3
12.5cm/5"
M27-127-12



2/3
13cm/4 ¾"
M27-129-13



2/3
12cm/4 ½"
M27-131-12



2/3
11.5cm/4 ½"
M27-133-11



2/3
11.5cm/4 ½"
M27-135-16



½
17 cm / 6 ¾"
M27-137-17



½
17 cm / 6 ¾"
M27-139-17



½
12 cm / 4 ¾" M27-141-12
14 cm / 5 ½" M27-141-14
16 cm / 6 ¼" M27-141-16



½
13 cm / 5 ½"
M27-143-13

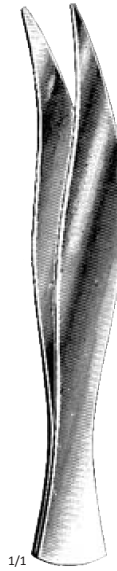

1/1
9 cm / 3 ½"
M27-145-09



1/1
9 cm / 3 ½"
M27-147-09

Forceps with Tungsten Carbide Inserts

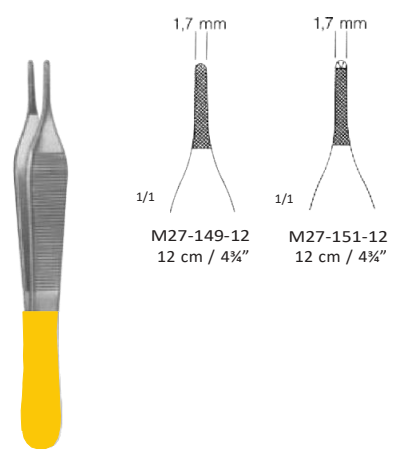

1,7 mm
1/1
M27-149-12
12 cm / 4 3/4"

1,7 mm
1/1
M27-151-12
12 cm / 4 3/4"

Adson

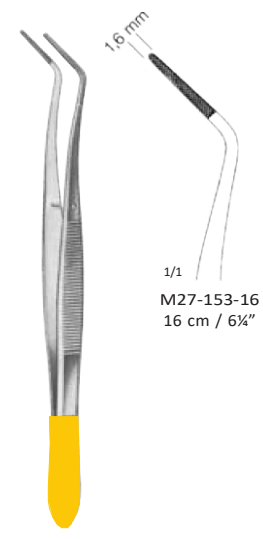

1,6 mm
1/1
M27-153-16
16 cm / 6 1/4"

Meriam

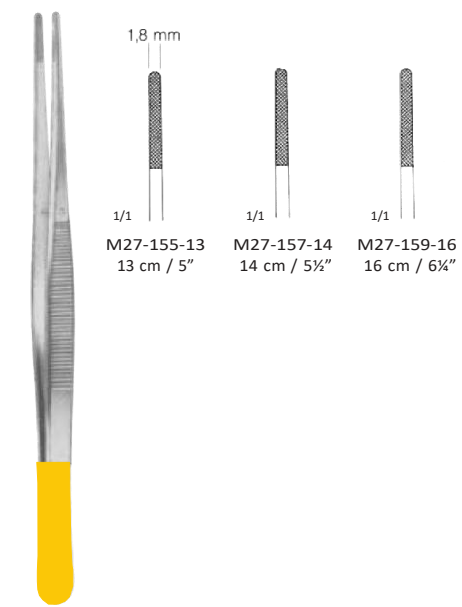

1,8 mm
1/1
M27-155-13
13 cm / 5"

1,8 mm
1/1
M27-157-14
14 cm / 5 1/2"

1,8 mm
1/1
M27-159-16
16 cm / 6 1/4"

Standard

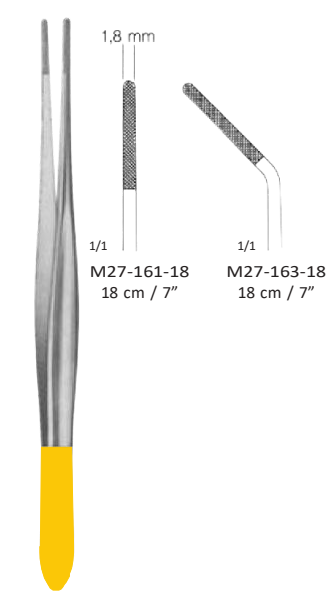

1,8 mm
1/1
M27-161-18
18 cm / 7"

1,8 mm
1/1
M27-163-18
18 cm / 7"

Cushing

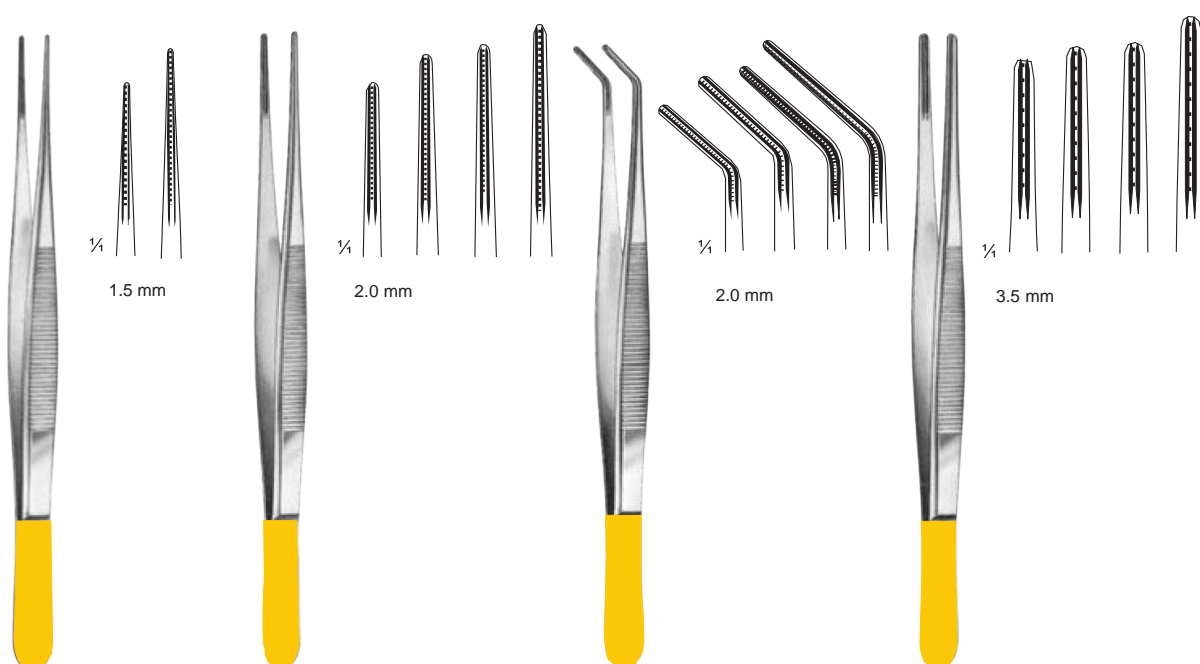

DeBakey

M27-165-16 = 16 cm/6 1/4"
M27-165-20 = 20 cm/8"

M27-167-16 = 16 cm/6 1/4"
M27-167-20 = 20 cm/8"
M27-167-24 = 24 cm/9 1/4"
M27-167-30 = 30 cm/12"

M27-169-16 = 16 cm/6 1/4"
M27-169-20 = 20 cm/8"
M27-169-24 = 24 cm/9 1/4"
M27-169-30 = 30 cm/12"

De Bakey

M27-171-16 = 16 cm/6 1/4"
M27-171-20 = 20 cm/8"
M27-171-24 = 24 cm/9 1/4"
M27-171-30 = 30 cm/12"



16cm / 6½"
M27-177-30
Fig-18L
Locking



15cm / 6"
M27-179-30
Fig-1
Self Locking



15cm / 6"
M27-181-30
Fig-2
Self Locking



14 cm/5 1/2"
M27-193-30
self-retaining,
round ends



14 cm/5 1/2"
M27-195-30
self retaining,
flat ends



	cm inches		
M27-197-30	12	4 3/4	M27-199-12
M27-197-14	14	5 1/2	M27-199-14
M27-197-16	16	6 1/4	M27-199-16



13 cm/5 1/8"
M27-201-13



13 cm/5 1/8"
M27-203-13
M27-205-00

M27-205-00
pair



16 cm/6 1/4"
M27-207-19
M27-209-00



16 cm/6 1/4"
M27-211-16
M27-213-00

M27-213-00
pair



16 cm/6 1/4"
M27-215-16 - M27-221-02



M27-215-16

Spare tips, in pairs



M27-217-16

M27-219-02

M27-221-02

◀ insulated handle

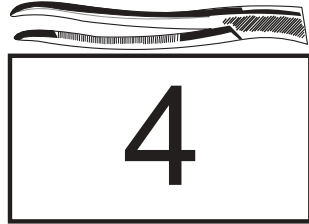

HEMOSTATIC FORCEPS

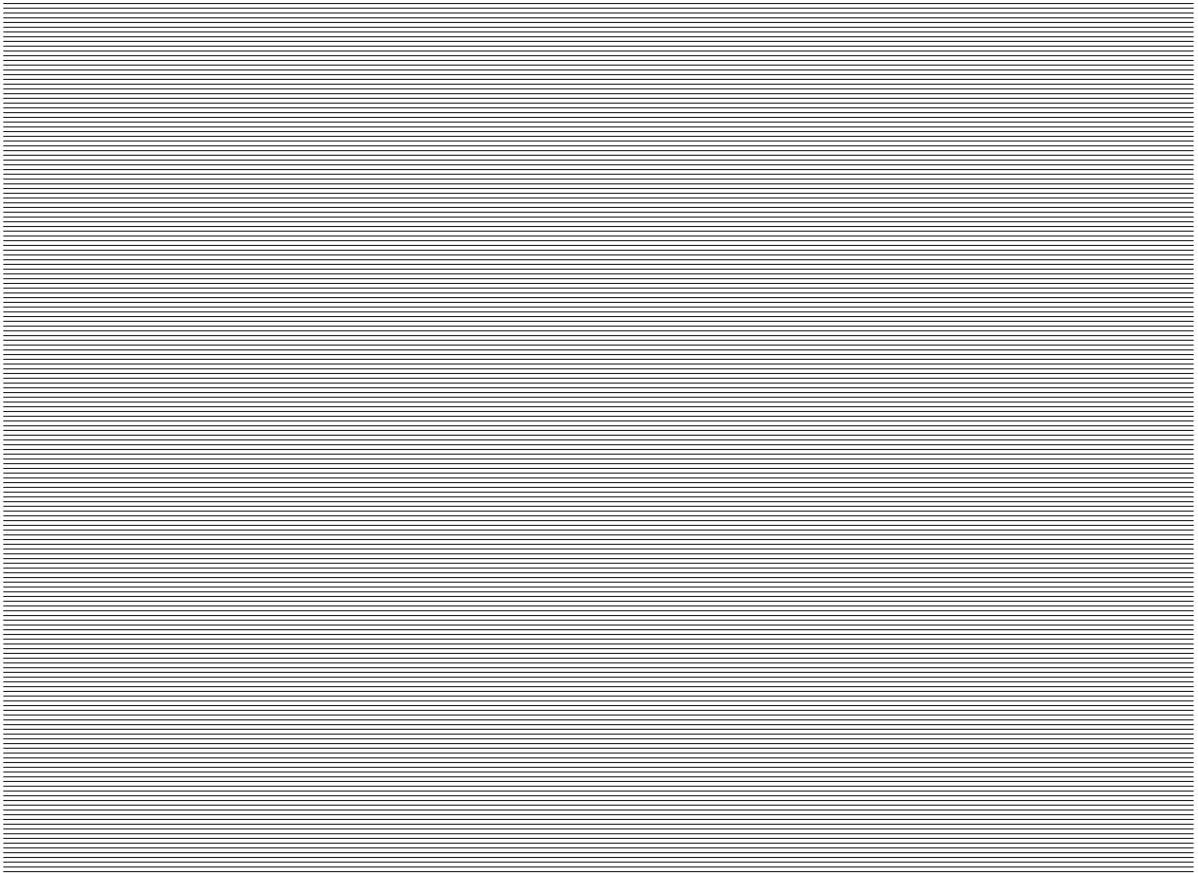



		Pean	
cm	in	Straight	Curved
13	5	M28-001-13	M28-003-13
14	5½	M28-001-14	M28-003-14
16	6¼	M28-001-16	M28-003-16



		Kocher	
cm	in	Straight	Curved
13	5	M28-005-13	M28-007-13
14	5½	M28-005-14	M28-007-14
16	6¼	M28-005-16	M28-007-16

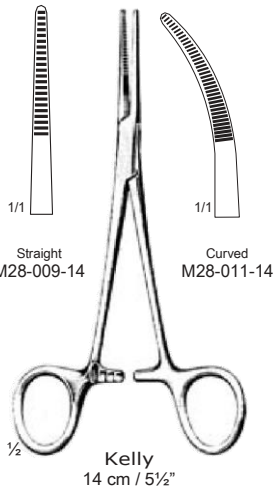

		Kelly	
cm	in	Straight	Curved
14	5½	M28-009-14	M28-011-14

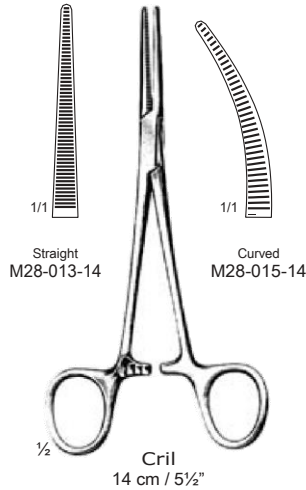

		Cril	
cm	in	Straight	Curved
14	5½	M28-013-14	M28-015-14

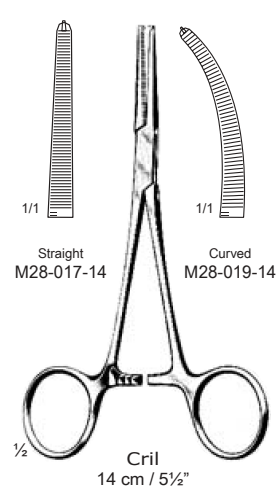

		Cril	
cm	in	Straight	Curved
14	5½	M28-017-14	M28-019-14

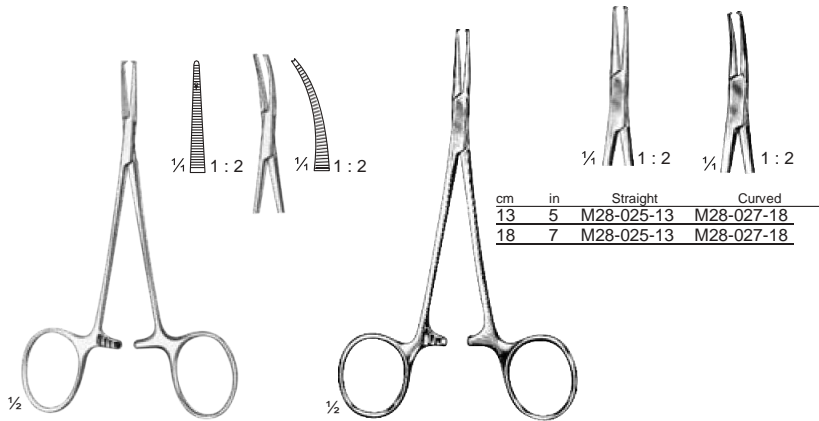

cm	in	Straight	Curved
13	5	M28-025-13	M28-027-18
18	7	M28-025-13	M28-027-18

Halstead-Mosquito (Micro)

cm	in	Straight	Curved
12.5	5	M28-021-12	M28-023-12

Halstead-Mosquito

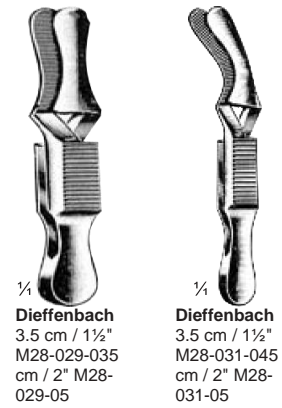

Dieffenbach
 3.5 cm / 1 1/2"
 M28-029-035
 cm / 2" M28-029-05

Dieffenbach
 3.5 cm / 1 1/2"
 M28-031-045
 cm / 2" M28-031-05

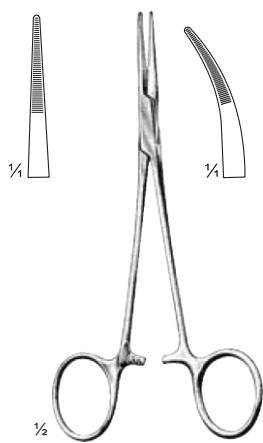

Providence-Hospital

cm	in	Straight	Curved
14	5 1/2	M28-033-14	M28-035-14

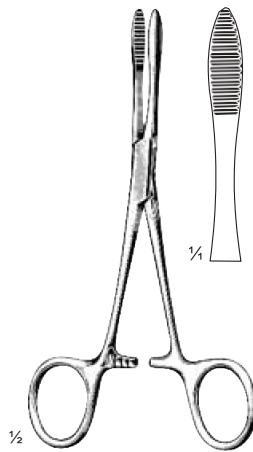

Pean

cm	in	
14	5 1/2	M28-037-14
16	6 1/4	M28-037-16

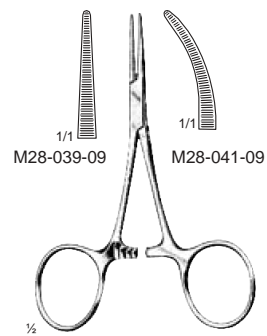

Hartmann
 10 cm / 4"

Hemostatic & Towel Forceps

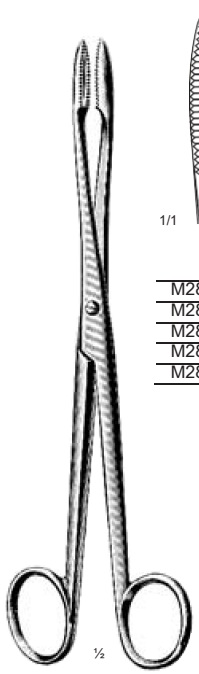

Gross-Maier

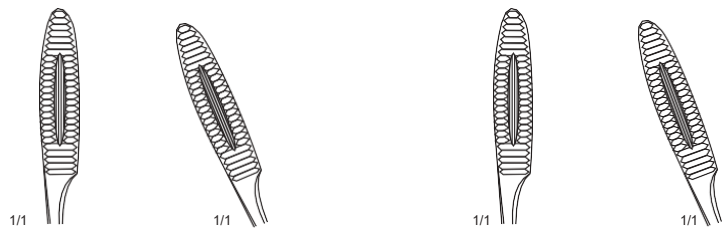

		cm	in		
M28-043-14	M28-045-14	14.5	5 1/2	M28-047-14	M28-049-14
M28-043-16	M28-045-16	16	6 1/4	M28-047-16	M28-049-16
M28-043-18	M28-045-18	18	7	M28-047-18	M28-049-18
M28-043-20	M28-045-20	20	8	M28-047-20	M28-049-20
M28-043-25	M28-045-25	25	10	M28-047-25	M28-049-25

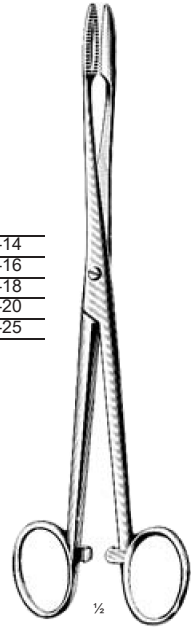

Gross-Maier

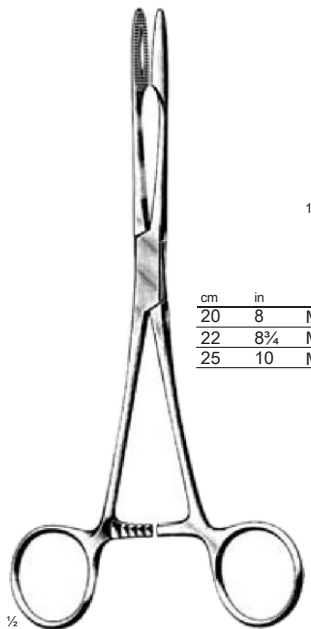

Gross-Maier

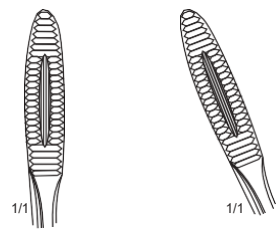

cm	in		
20	8	M28-051-20	M28-053-20
22	8 3/4	M28-051-22	M28-053-22
25	10	M28-051-25	M28-053-25

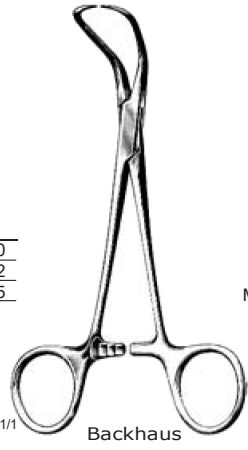

Backhaus

cm	in	
8	3 1/4	M28-055-08
11	4 1/2	M28-055-11
13	5	M28-055-13
15	6	M28-055-15

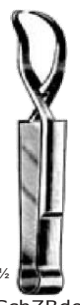

SchZBdel
9 cm / 3 1/2"
M28-057-09



Jones
5 cm / 2"
M28-059-05
9 cm / 3 1/2"
M28-059-09

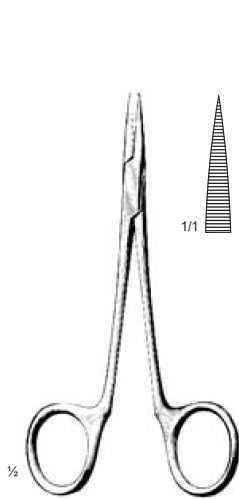

Physician
13 cm / 5"
M28-061-13

(4x5 Teeth)
M28-063-15

(5x6 Teeth)
M28-065-15



Allis
15 cm / 6"

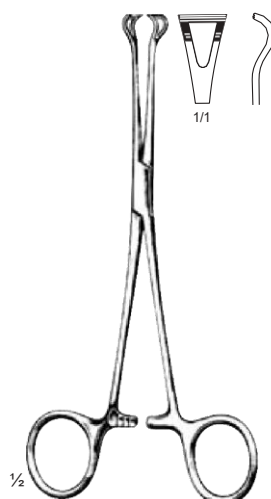

Babcock
16 cm / 6 1/4"
M28-067-16

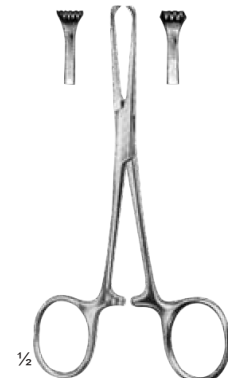

Allis-Baby
14.5 cm / 5 3/4"
M28-069-14



Cheatele
27 cm / 10 1/2"
M28-071-27

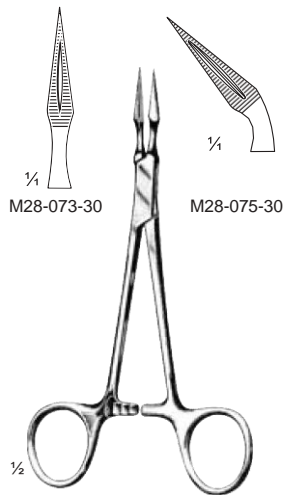

Stieglitz
13.5 cm / 5 1/2"



Peet
11.5 cm / 4 1/2"
M28-077-30

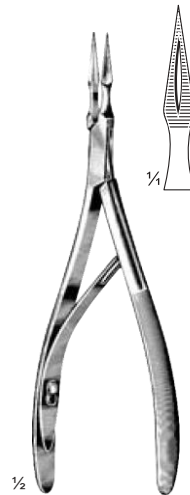

Ralk
15 cm / 6"
M28-079-30

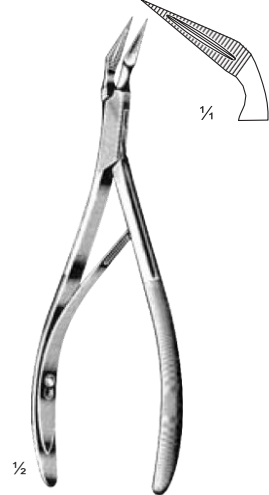

Ralk
15 cm / 6"
M28-081-30

Universal Seizing Forceps, Waste Forceps

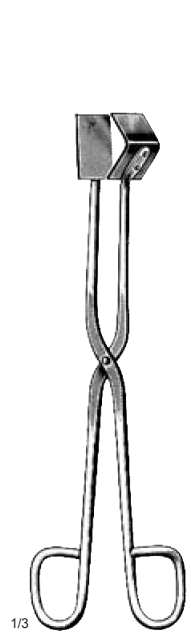

24 cm / 9½"
M28-083-24

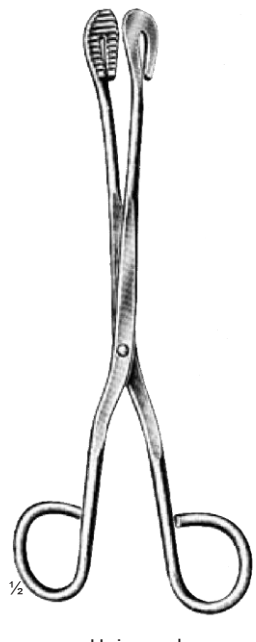

Universal
20 cm / 8" M28-085-20
28 cm / 11" M28-085-28

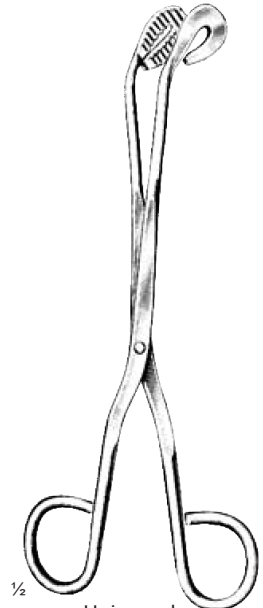

Universal
20 cm / 8" M28-087-20
28 cm / 11" M28-087-28



58 cm / 22¾"
M28-089-58



Sauerbruch
55 cm / 21½"
M28-091-55



22 cm / 8" M28-093-22
32 cm / 12½" M28-093-32
50 cm / 20" M28-093-50

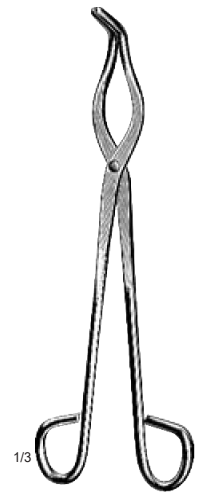

22 cm / 8" M28-095-22
25 cm / 10" M28-095-25
32 cm / 12½" M28-095-32
50 cm / 20" M28-095-50

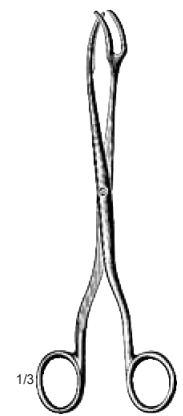

20 cm / 8" M28-097-20
30 cm / 12" M28-097-30

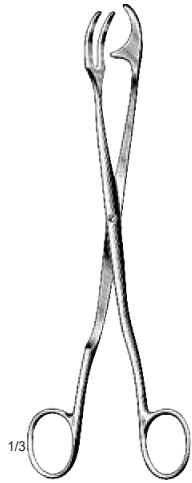

Rogge
23 cm / 9"
M28-099-23



24.5 cm / 9¾"
M28-101-24



5

ROOT ELEVATORS



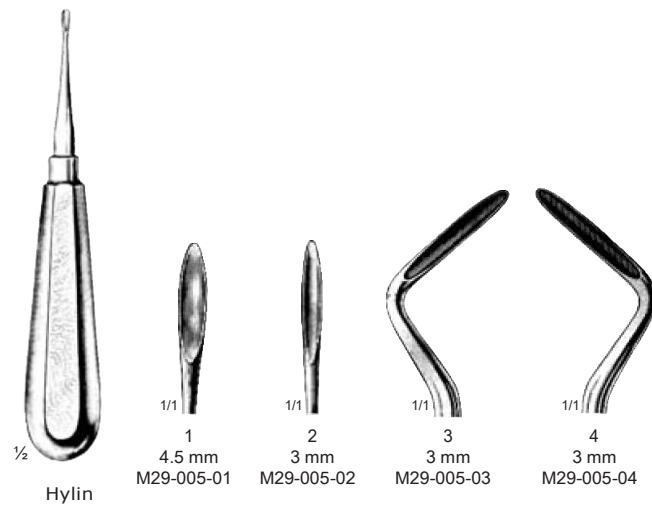
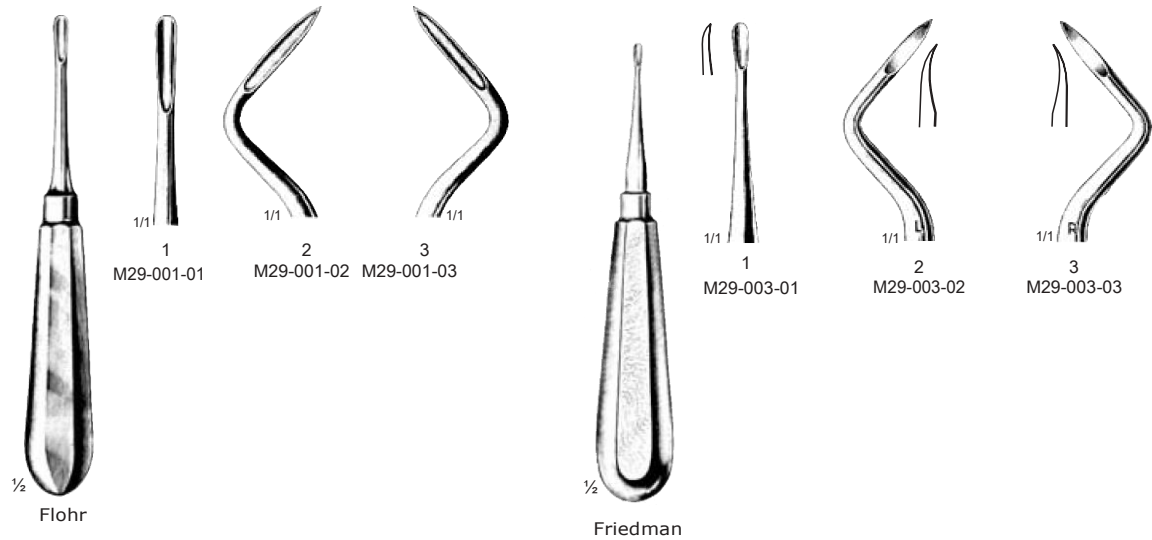

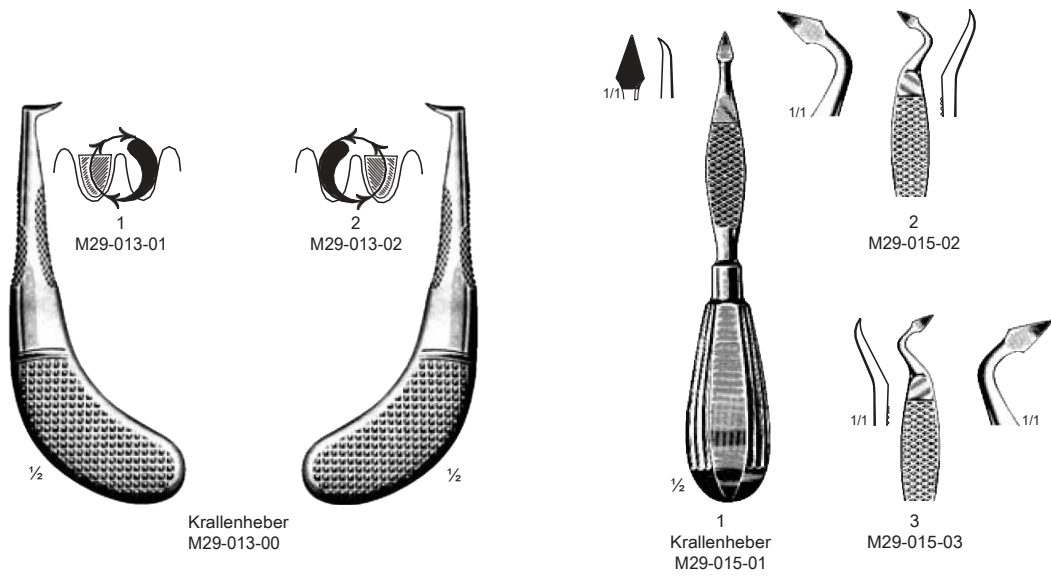
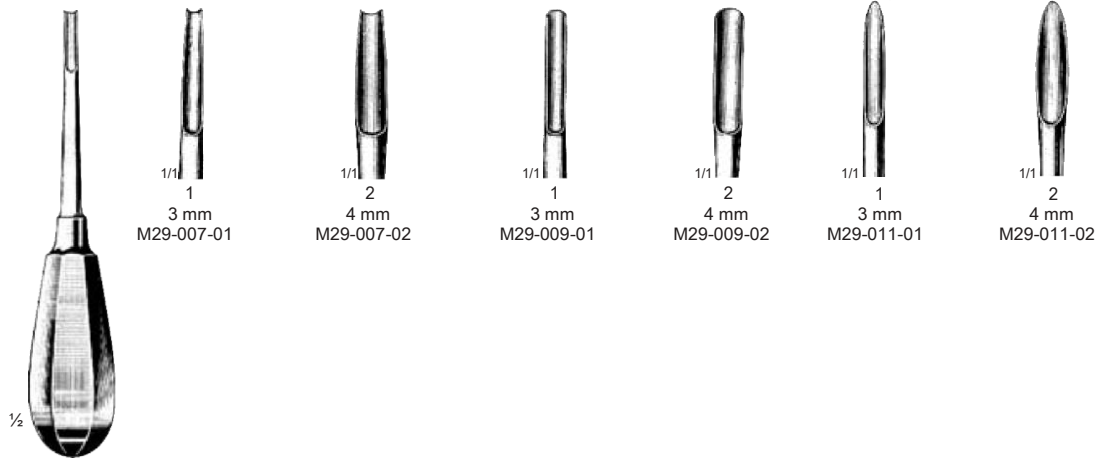

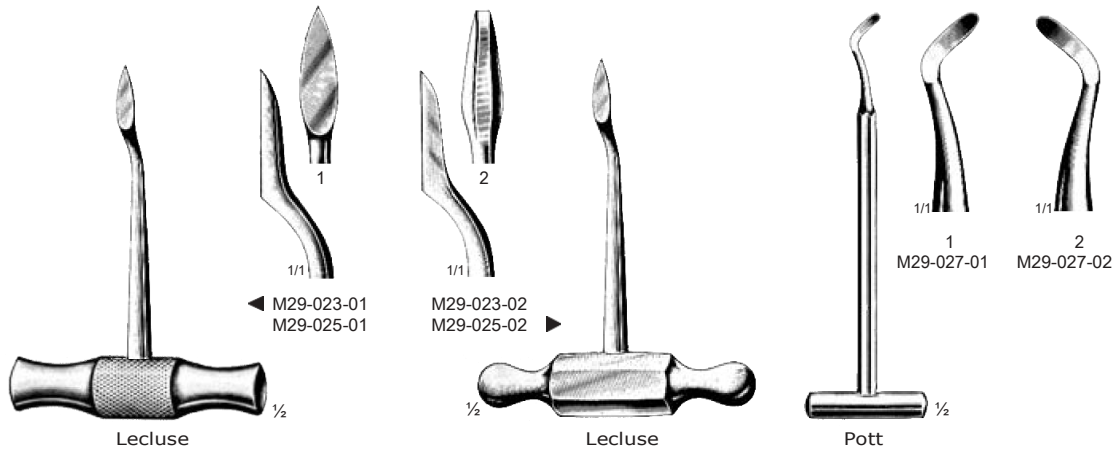
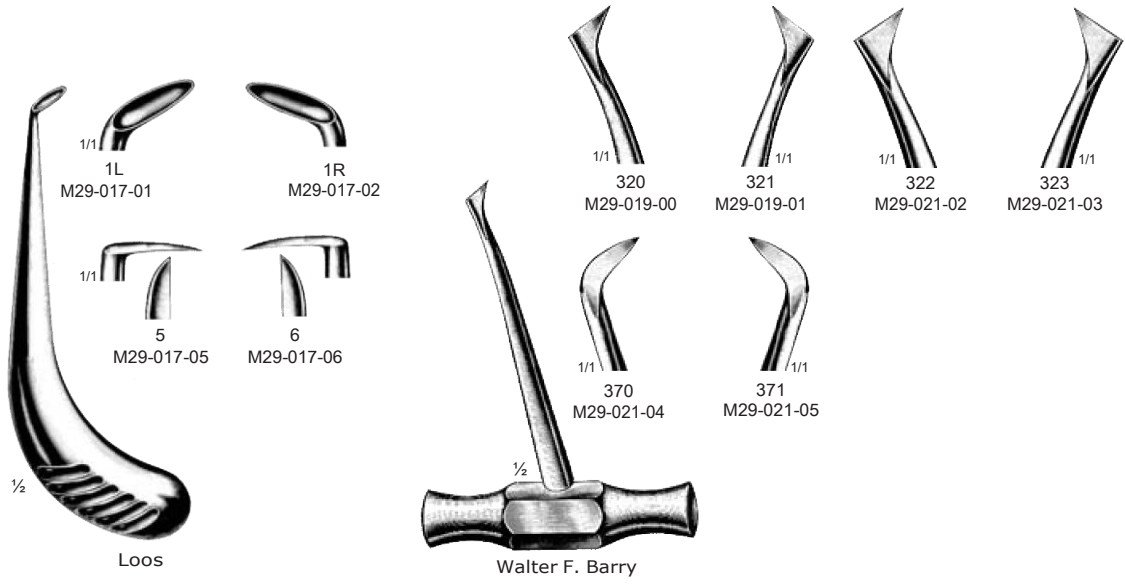

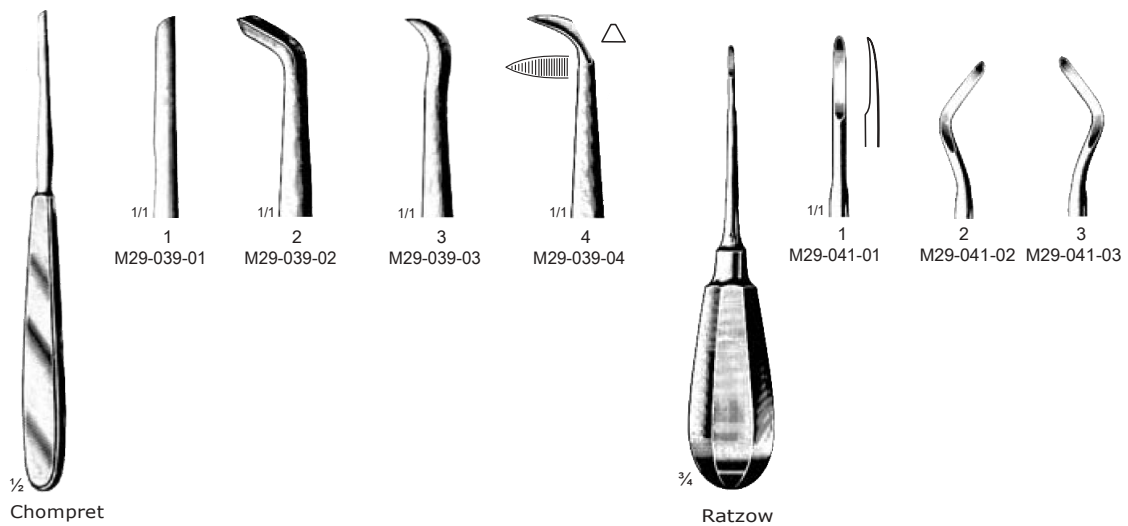
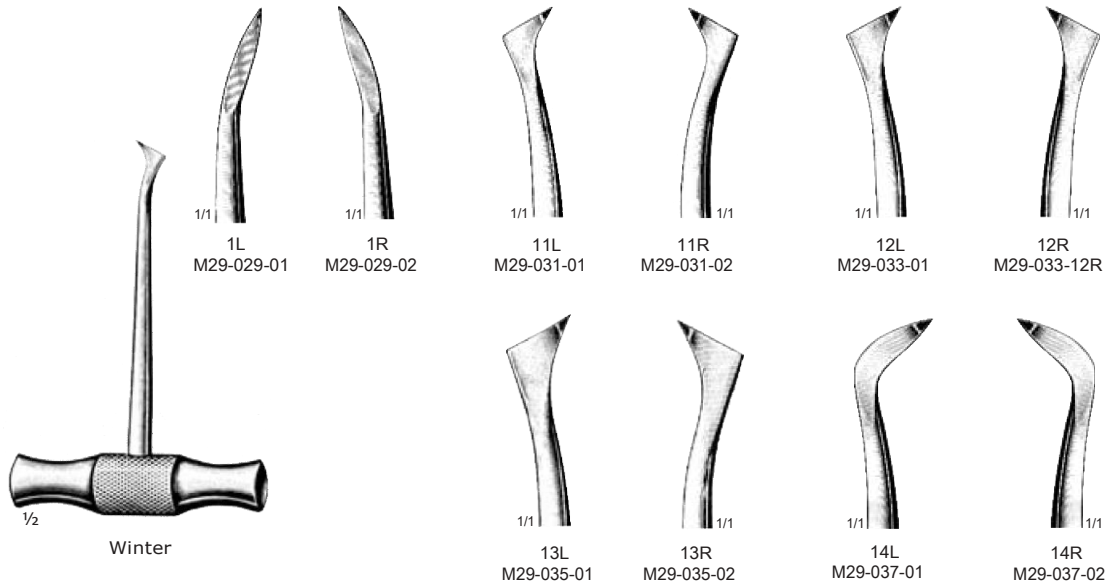



Heidebrink



Heidebrink
M29-043-01

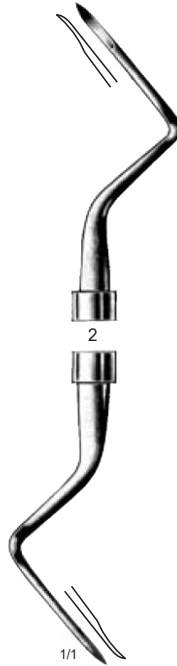

Heidebrink
M29-045-02

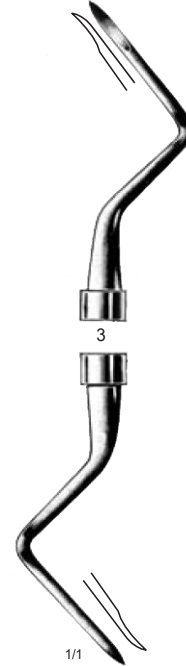

Heidebrink
M29-047-03



Heidebrink
M29-049-00



M29-049-01
M29-051-01



M29-049-02
M29-051-02



M29-049-03
M29-051-03



Heidebrink
M29-051-00

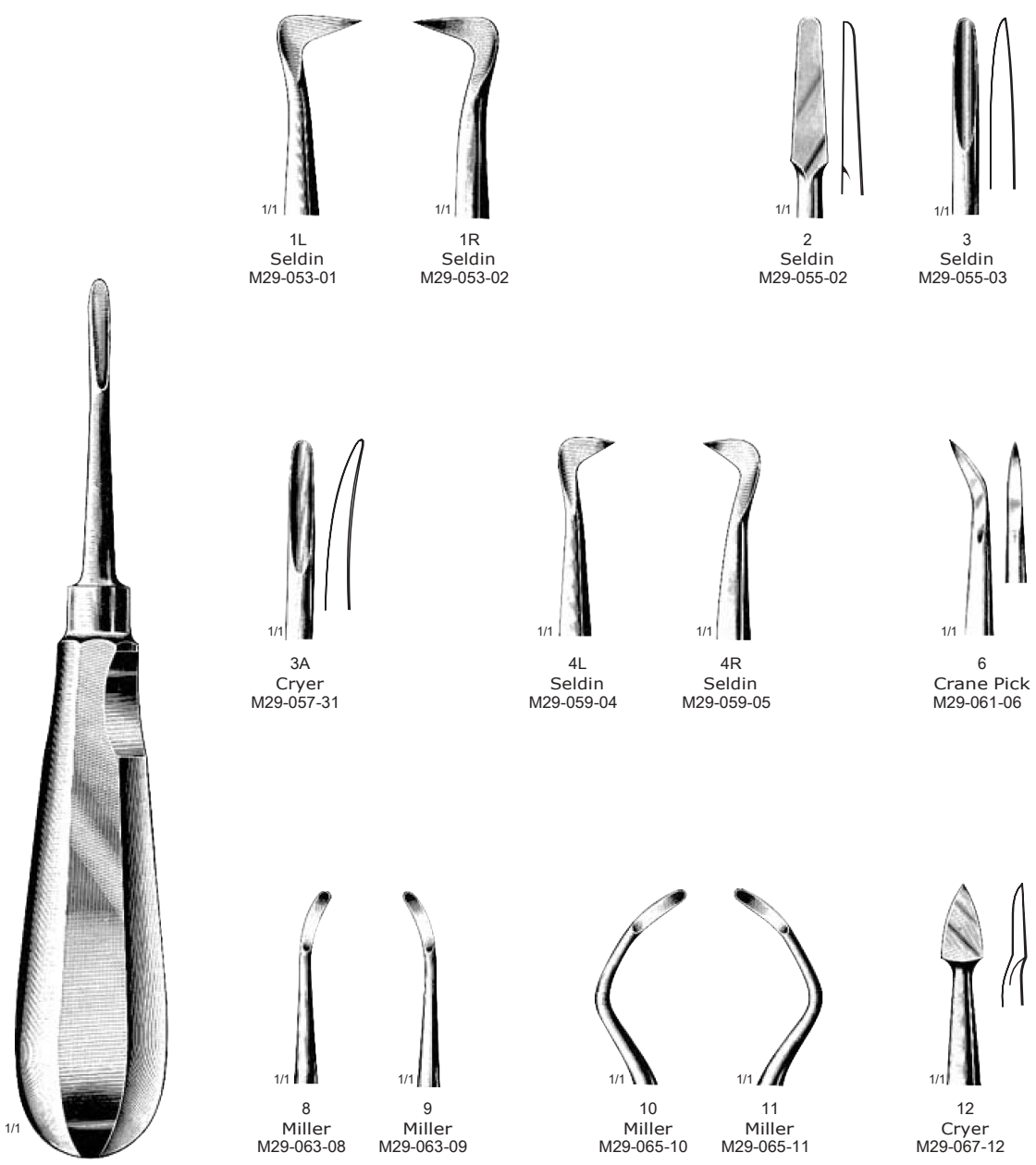

1/1
1L
Seldin
M29-053-01

1/1
1R
Seldin
M29-053-02

1/1
2
Seldin
M29-055-02

1/1
3
Seldin
M29-055-03

1/1
3A
Cryer
M29-057-31

1/1
4L
Seldin
M29-059-04

1/1
4R
Seldin
M29-059-05

1/1
6
Crane Pick
M29-061-06

1/1
8
Miller
M29-063-08

1/1
9
Miller
M29-063-09

1/1
10
Miller
M29-065-10

1/1
11
Miller
M29-065-11

1/1
12
Cryer
M29-067-12

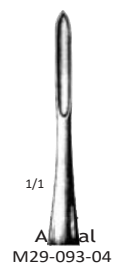
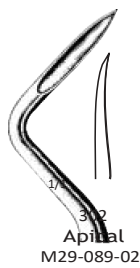
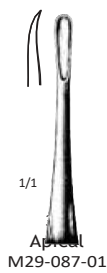
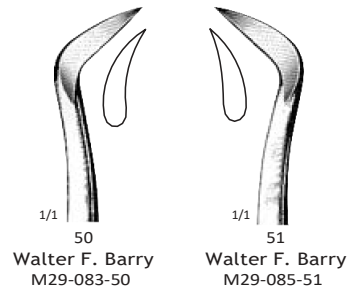
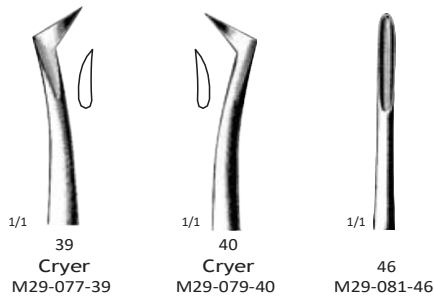
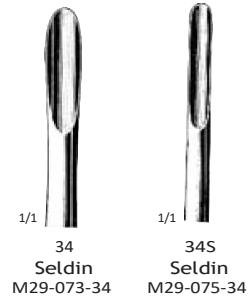
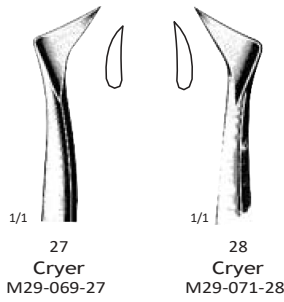
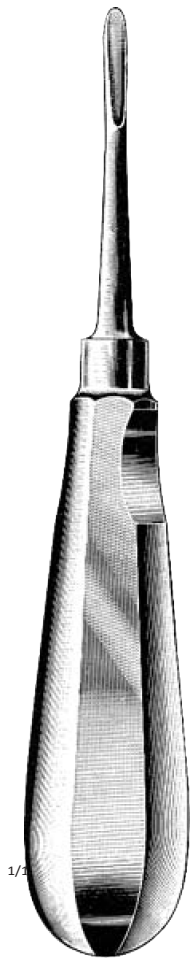

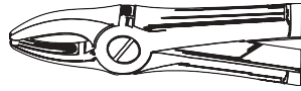

6

EXTRACTING FORCEPS



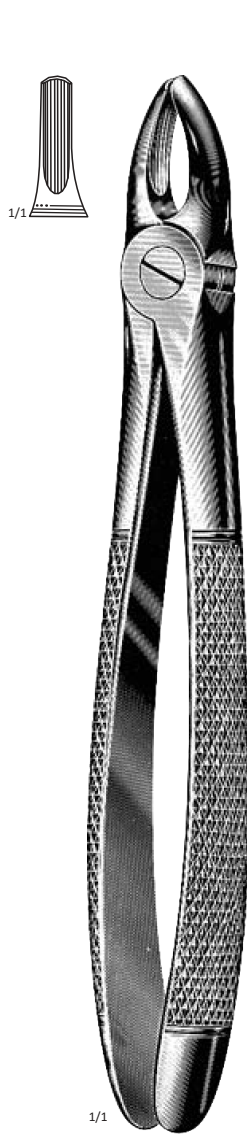

1
M30-001-01
For Upper Centrals and Canines

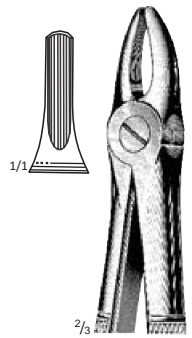

2
M30-003-02
For Upper Laterals and Bicuspids

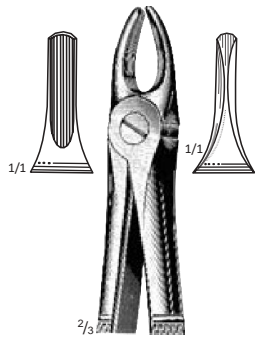

3
M30-005-03
For Upper Incisors and Canines
Crowned Internally & Externally

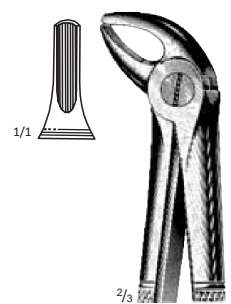

4
M30-007-04
For Lower Incisors and Canines

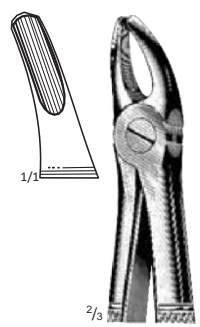

7
M30-009-07
For Upper Bicuspids, either side

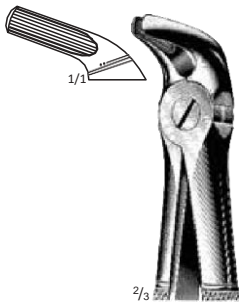

8
M30-011-08
For Lower Bicuspids, either side

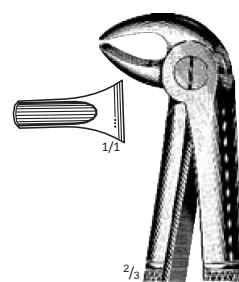

13
M30-013-13
For Lower Bicuspids, either side

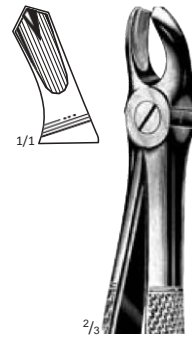

17
M30-015-17
For Right Upper Molars

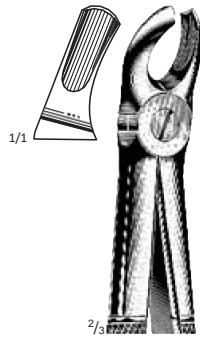

18
M30-017-18
For Left Upper Molars

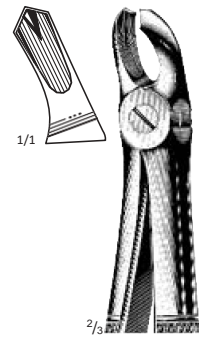

18A
M30-019-18
For Upper Molars-either side

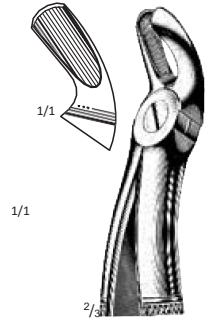

19
M30-021-19
For Upper Wisdoms-either side

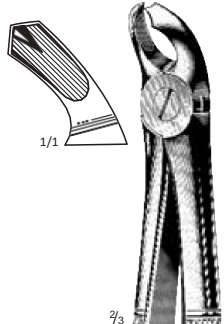

20
M30-023-20
For Lower Wisdoms-either side

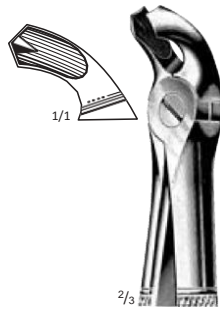

21
M30-025-21
For Lower Molars-either side

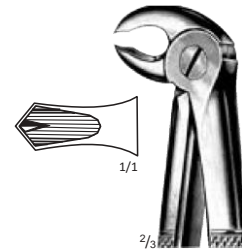

22
M30-027-22
For Lower Molars-either side

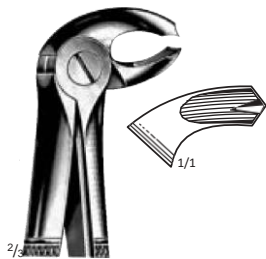

23
M30-029-23
For Right Lower Molars

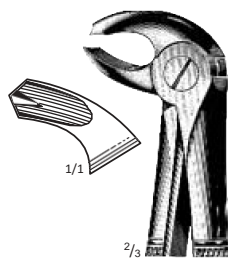

24
M30-031-24
For Left Lower Molars

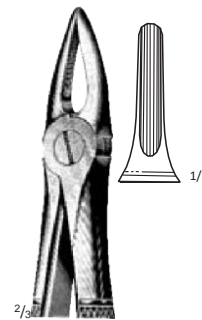

29
M30-033-29
For Upper Roots and Incisors-either side

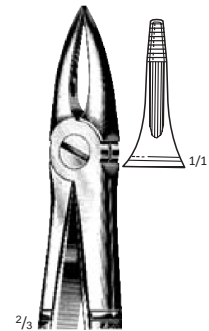

29N
M30-035-29
For Roots of Upper Incisors

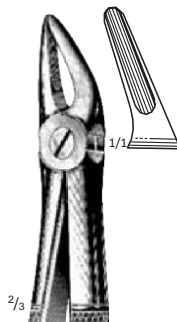

30
M30-037-30
For Upper Roots and Incisors-either side

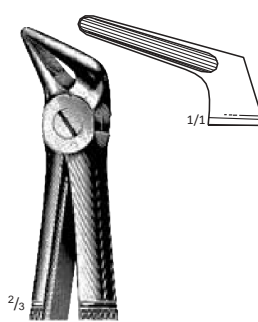

31
M30-039-31
For Lower Roots-either side

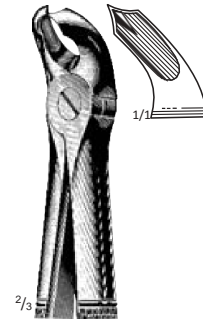

32
M30-041-32

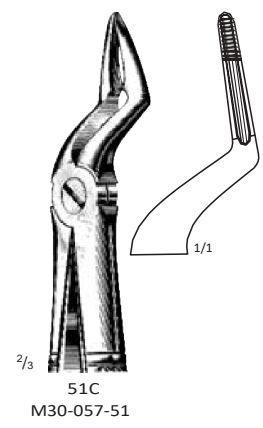
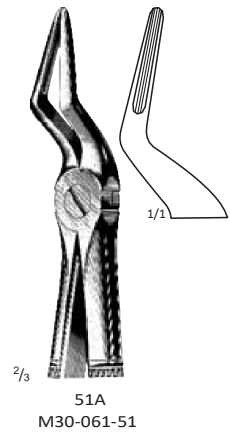
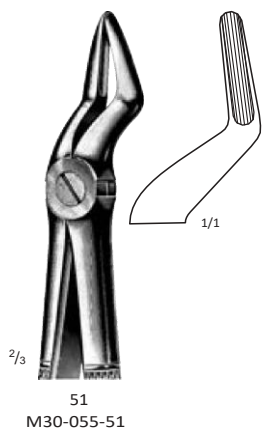
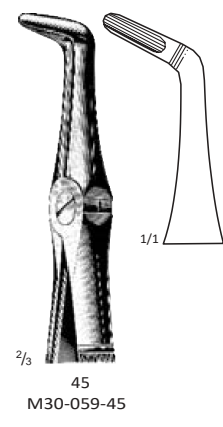
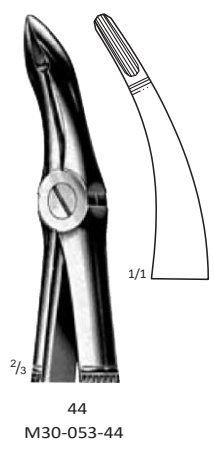
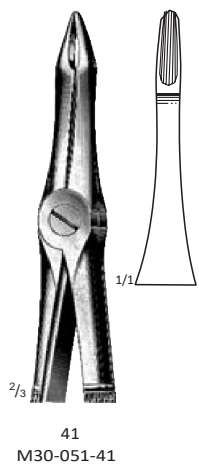
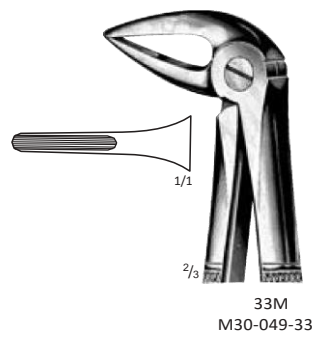
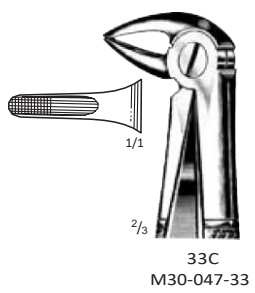
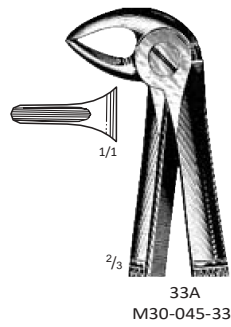
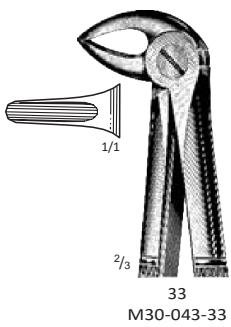

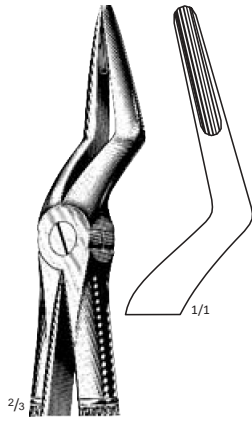

51M
M30-063-51
For Deep Upper Roots

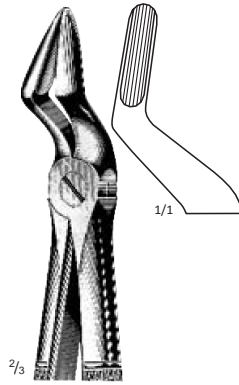

52
M30-069-52
For Upper Roots and Canines

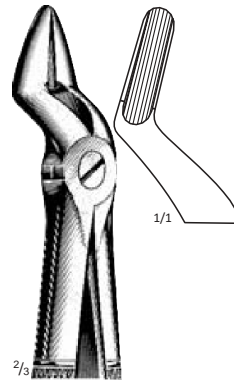

52A
M30-065-52
For Upper Teeth and Resection-either side

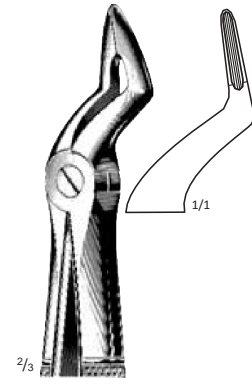

53 Witzel
M30-071-53
For Upper Roots

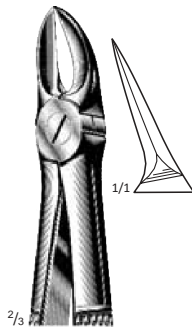

55
M30-067-55
For Separating Upper Molar Roots

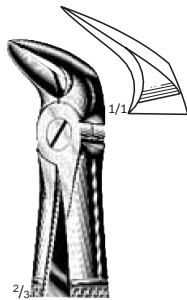

56
M30-073-56
For Separating Lower Molar Roots

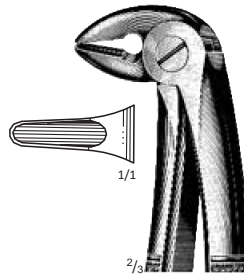

59
Busch
M30-075-59
Resection Forceps for Lower Roots

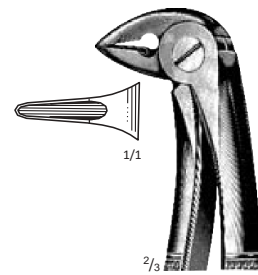

60
Busch
M30-077-60
Resection Forceps for Lower Roots

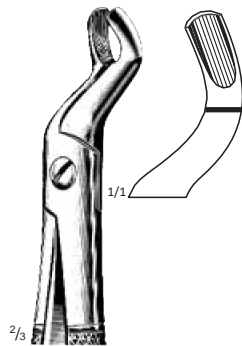

67
M30-079-67
For Upper Wisdoms, either side

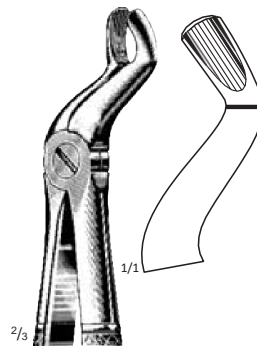

67A
M30-081-67
For Upper Wisdoms, either side

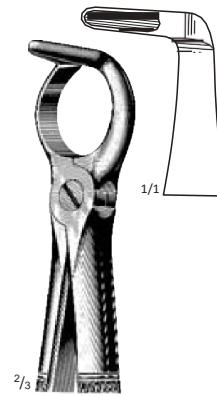

68
M30-083-68
For Lower Roots, either side

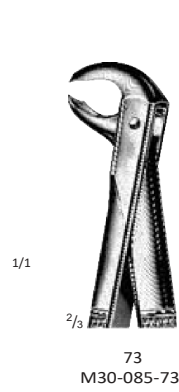

73
M30-085-73

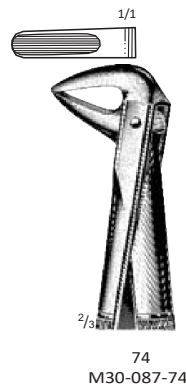

74
M30-087-74

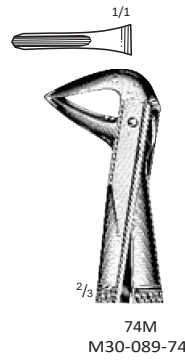

74M
M30-089-74

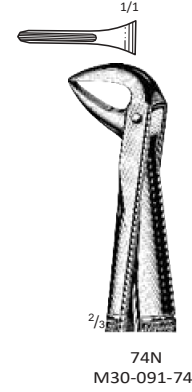

74N
M30-091-74

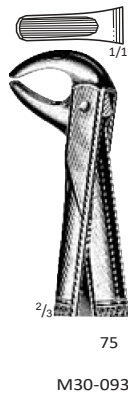

75
M30-093-75

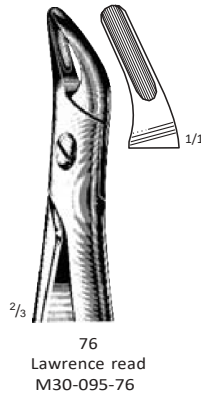

76
Lawrence read
M30-095-76

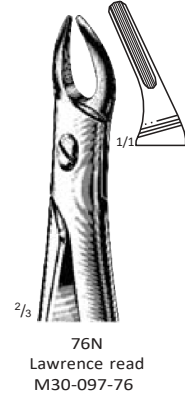

76N
Lawrence read
M30-097-76

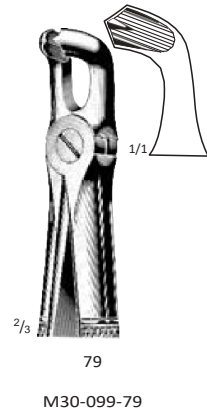

79
M30-099-79

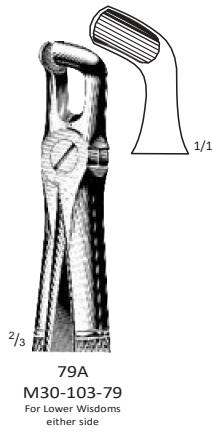

79A
M30-103-79
For Lower Wisdoms
either side

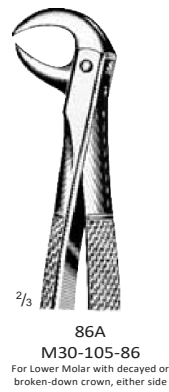

86A
M30-105-86
For Lower Molar with decayed or
broken-down crown, either side

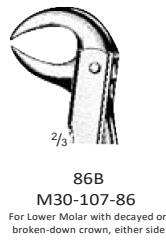

86B
M30-107-86
For Lower Molar with decayed or
broken-down crown, either side

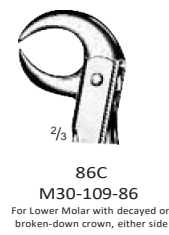

86C
M30-109-86
For Lower Molar with decayed or
broken-down crown, either side

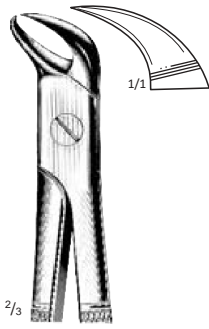

87
M30-111-87
For Lower Molar with decayed or broken-down crown, either side

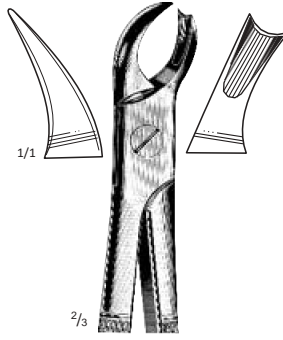

89
M30-113-89
For Right Upper Molar

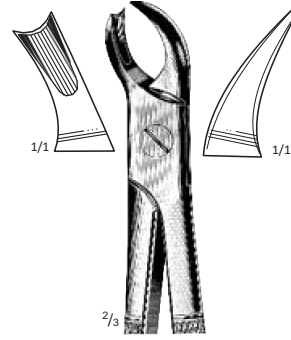

90
M30-115-90
For Left Upper Molar

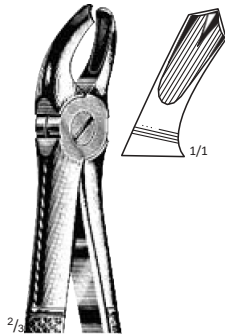

94
M30-117-94
For Right Upper Molar

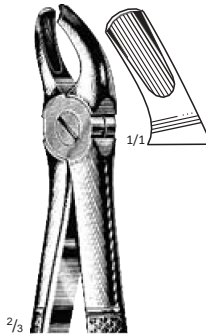

95
M30-119-95
For Left Upper Molar



99
Wood
M30-121-99
For Broken-Down Lower Molar either side



99½
Passow
M30-123-99
For Broken-Down Lower Molar either side

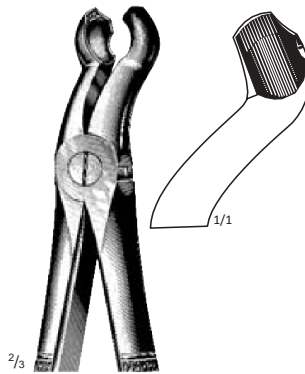

121
Ogden-Felsch
M30-125-21
For Upper Wisdoms

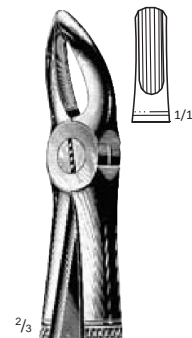

136
Guy
M30-127-36
For Upper Centrals and Roots



137
Guy
M30-129-37
For Lower Centrals and Roots

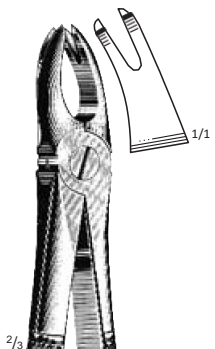

166
Trotter
M30-131-66
For Upper Teeth, Bicuspids



167
Trotter
M30-133-67
For Lower Teeth, Bicuspids

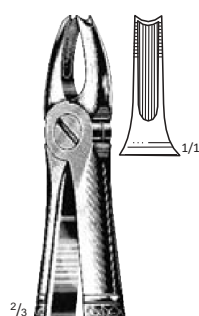

168
Trotter
M30-135-68
For Upper Canines

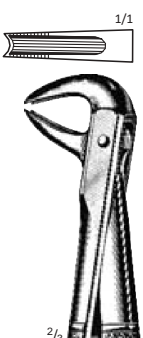

169
Trotter
M30-137-69
For Lower Canines and, Bicuspids

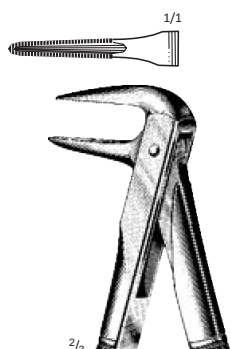

233
M30-139-33
For Lower Roots

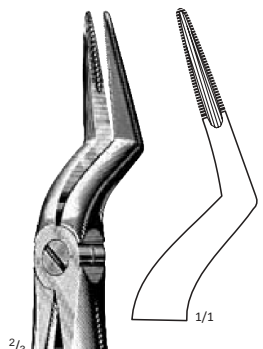

235
M30-141-35
For Upper Roots



1
M30-149-01
For Upper Central and Canines

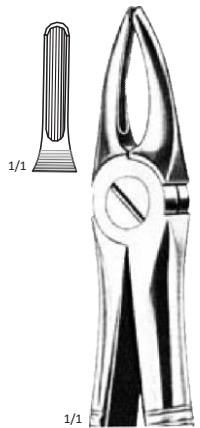

2
M30-143-02
For Upper Laterals
and Bicuspids

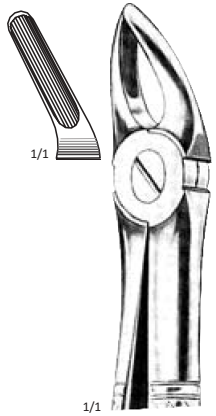

7
M30-145-07
For Upper Bicuspid
either side

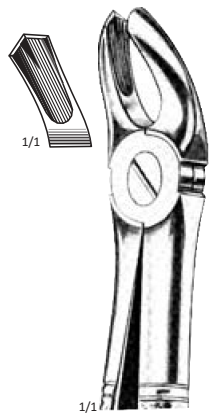

17
M30-147-17
For Right Upper Molars

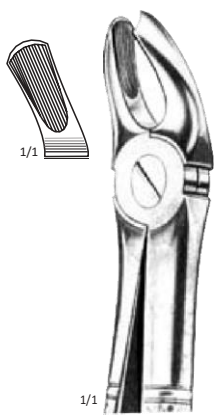

18
M30-151-18
For Left Upper Molars

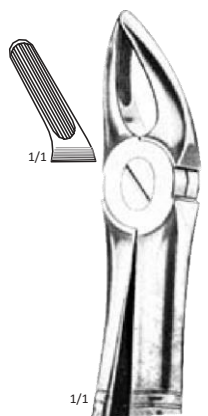

30
M30-153-30
For Upper Incisors and Roots
either side

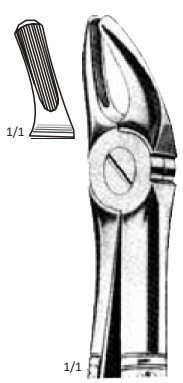

39
M30-155-39
For Upper Molars
either side

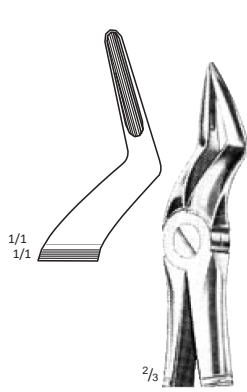

51
M30-157-51
For Upper Roots

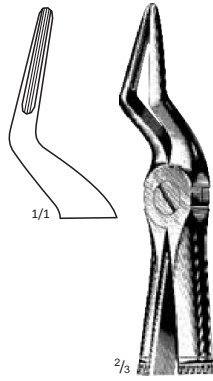

51A
M30-159-51
For Upper Roots

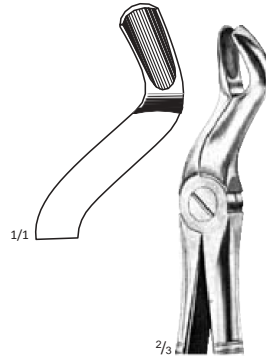

67A
M30-161-67
For Upper Wisdoms, either side

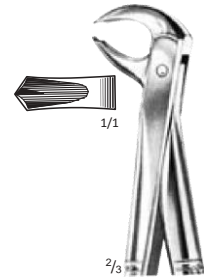

73
M30-163-73
For Lower Molars-either side

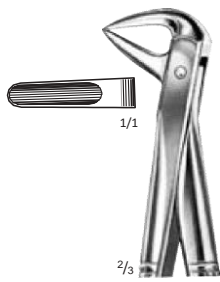

74
M30-165-74
For Lower Incisors and Roots-either side

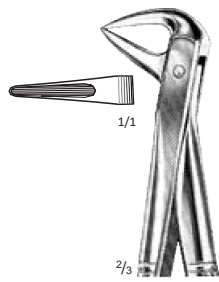

74N
M30-167-74
For Lower Incisors and Roots

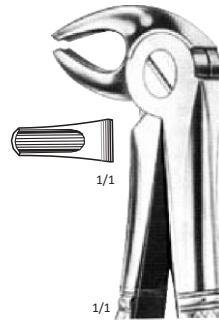

13
M30-169-13
For Lower Bicuspsids-either side

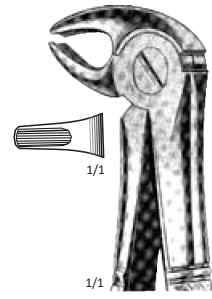

13S
M30-171-13
For Lower Bicuspsids-either side

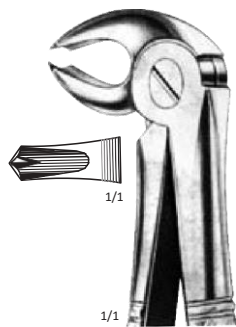

22
M30-175-22
For Lower Molars-either side

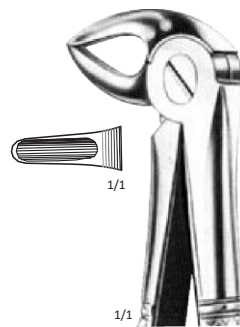

33
M30-177-33
For Lower Roots-either side

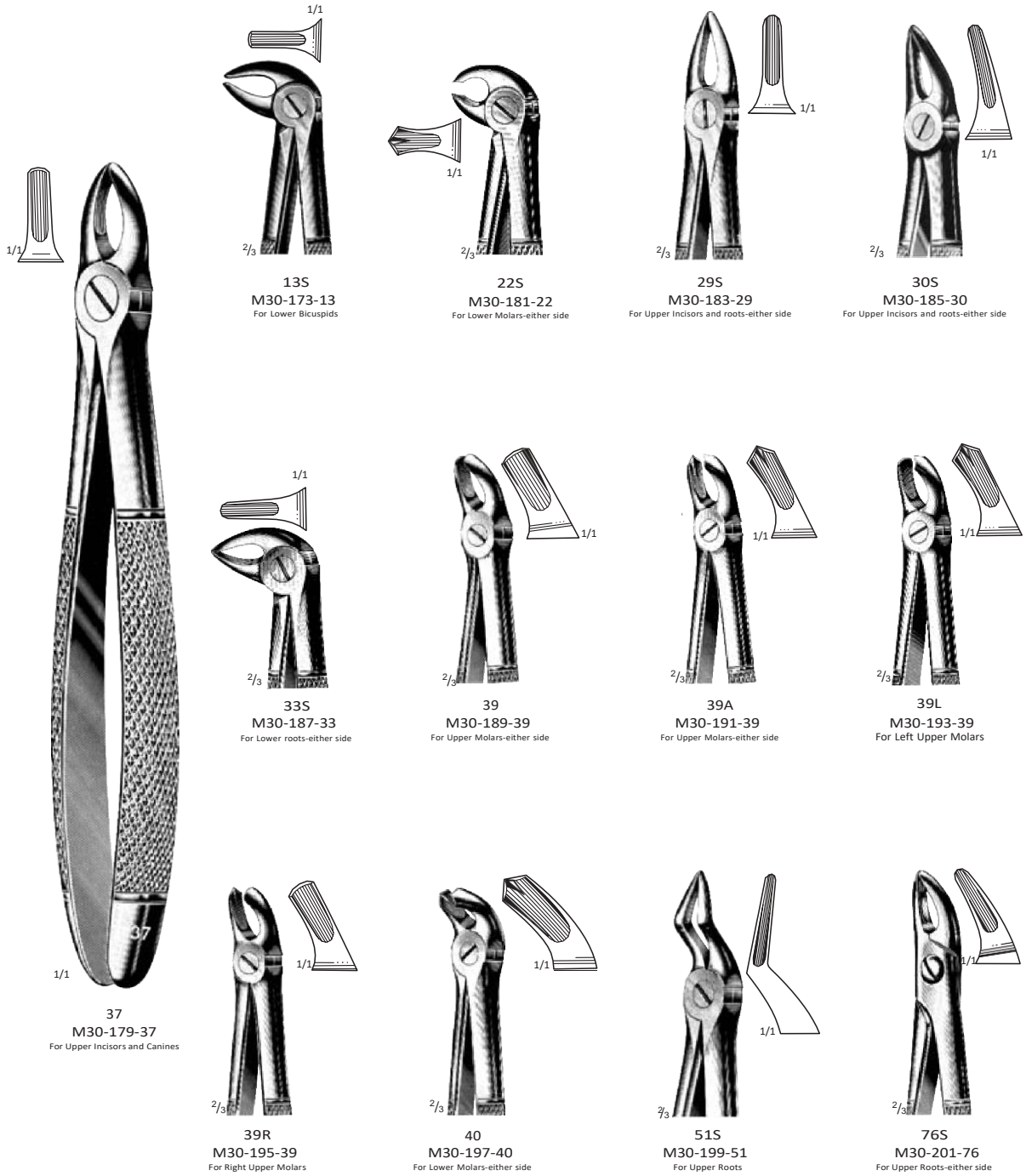

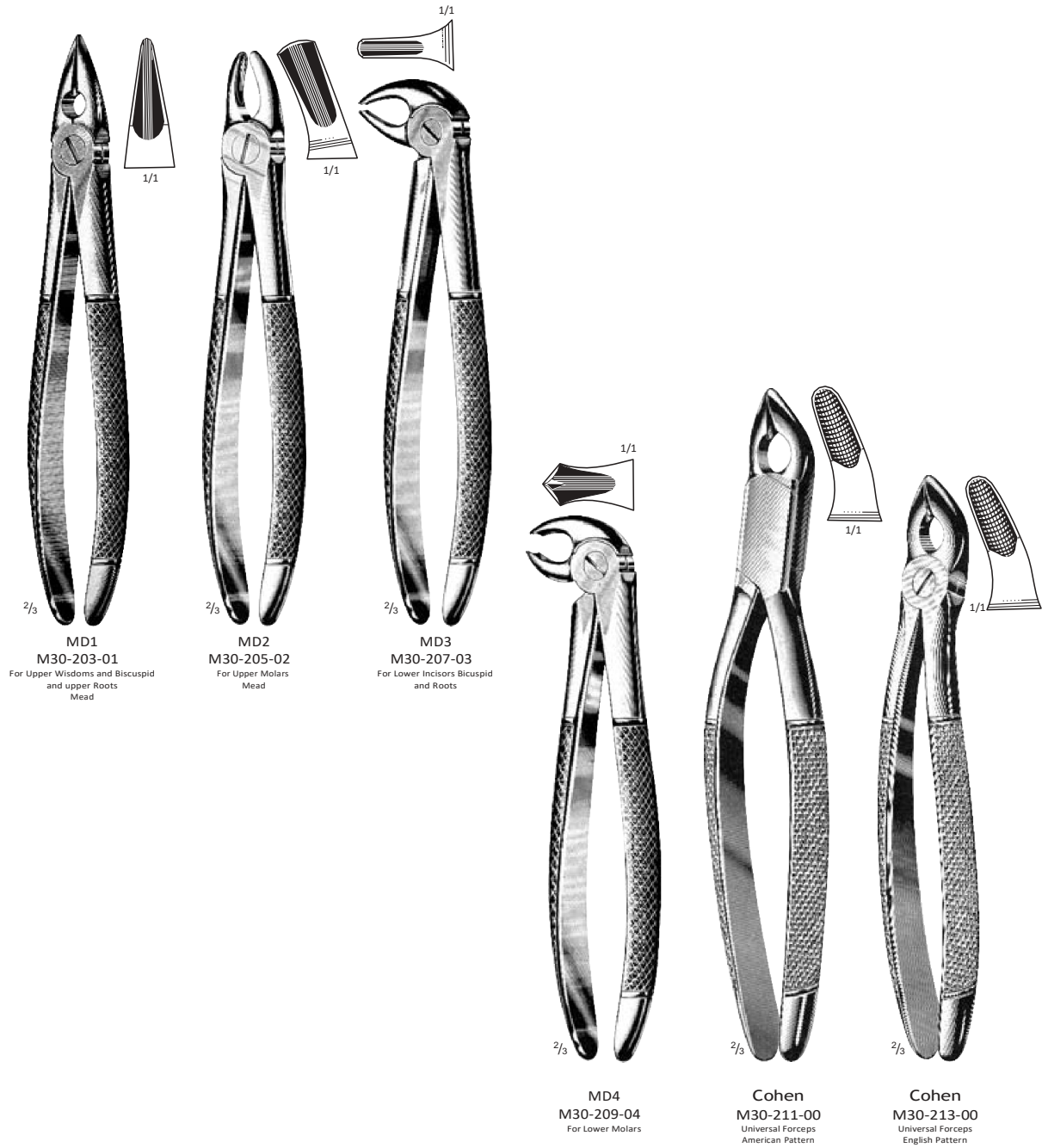

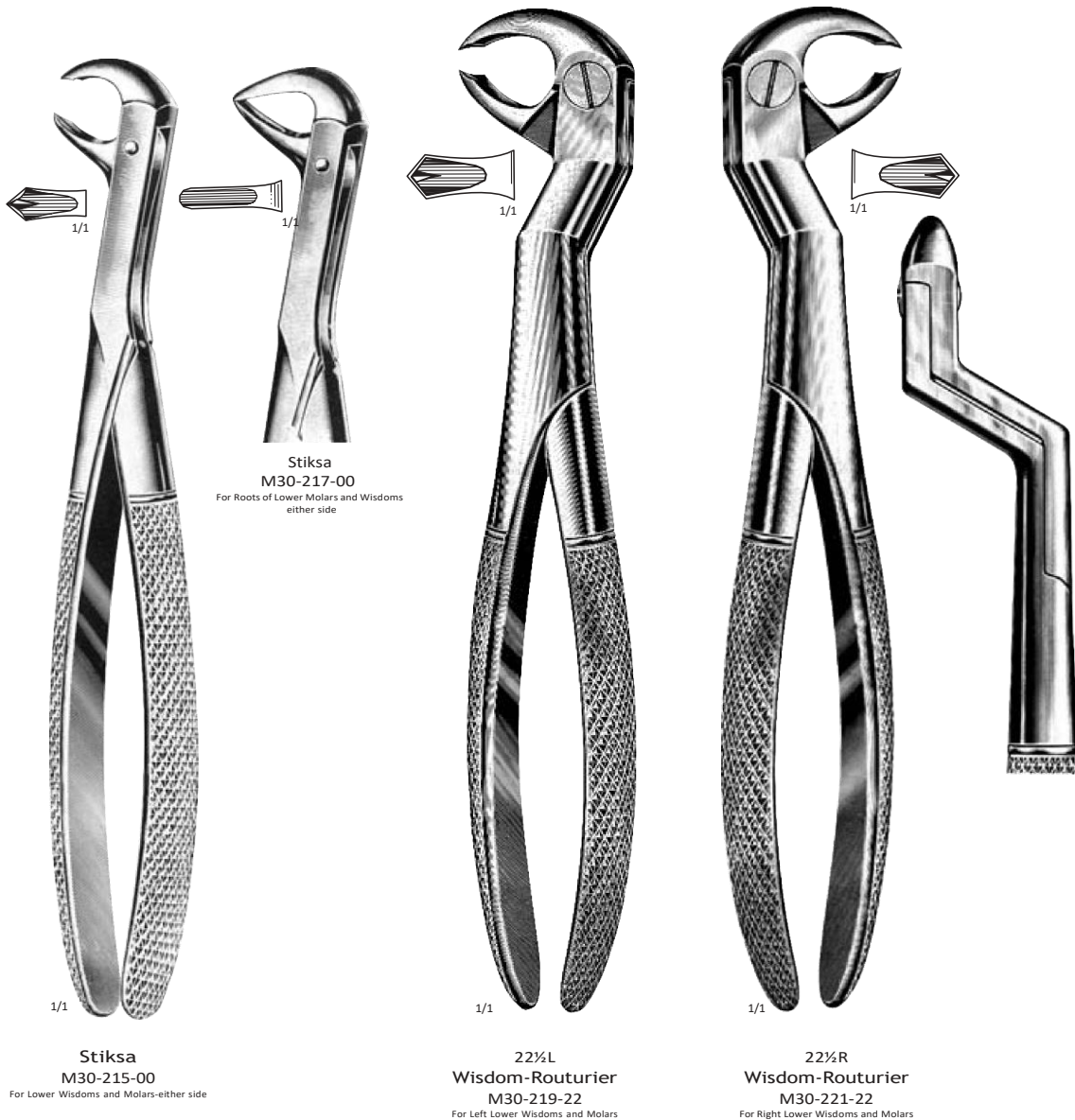



3
Klein
M30-223-03
For Upper Molars

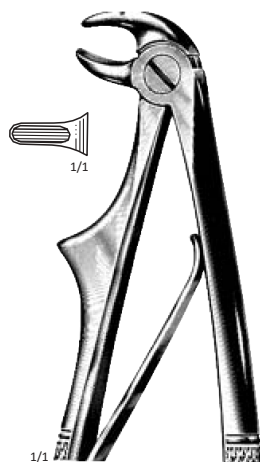

5
Klein
M30-225-05
For Lower Incisors

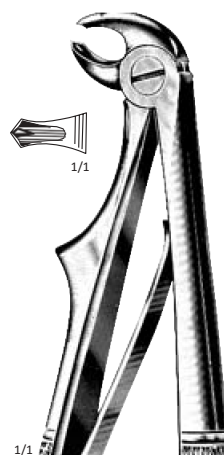

6
Klein
M30-227-06
For Lower Molars

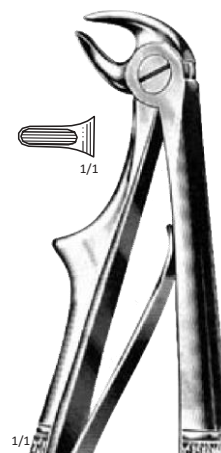

7
Klein
M30-229-07
For Lower Roots

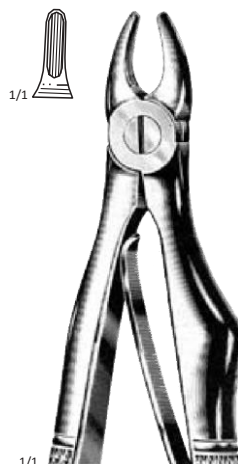

137
Klein
M30-231-37
For Upper Incisors and Canines

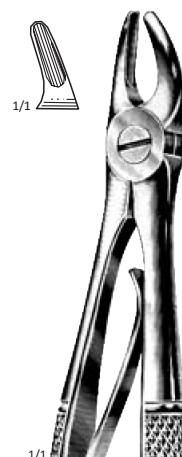

139
Klein
M30-233-39
For Upper Bicuspids

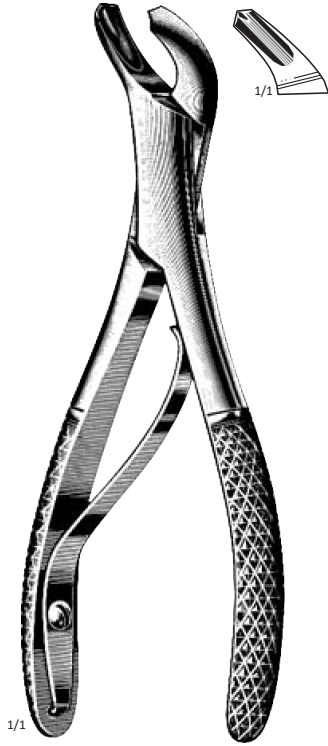

17SK
M30-235-17
For Lower Molars-either side

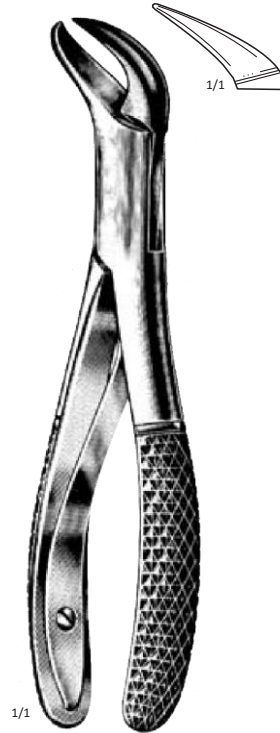

23SK
M30-237-23
For Lower Molars-either side

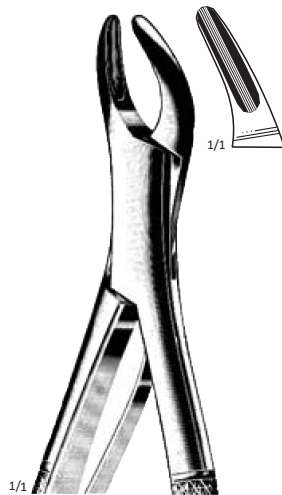

150SK
M30-239-50
For Upper Teeth and Roots

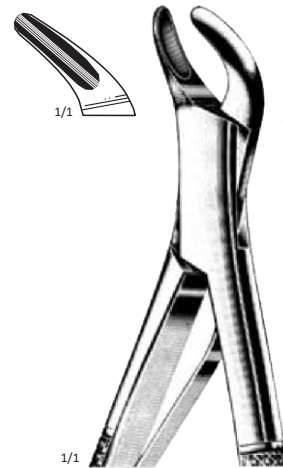

151SK
M30-241-51
For Lower Teeth and Roots

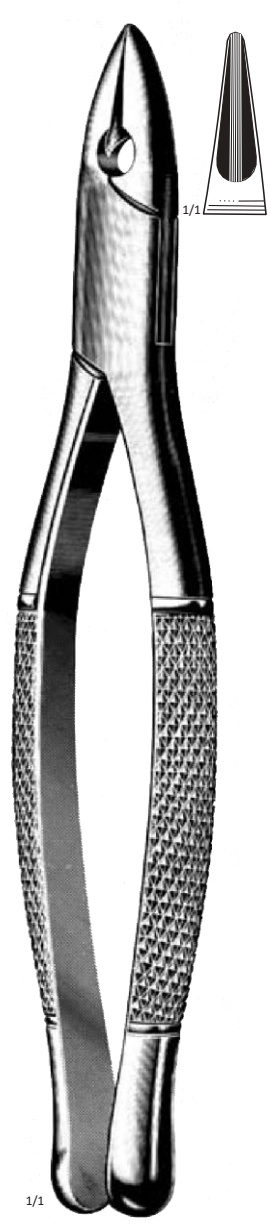

1
Standard
M30-243-01
For Upper Central, Laterals and Cuspid

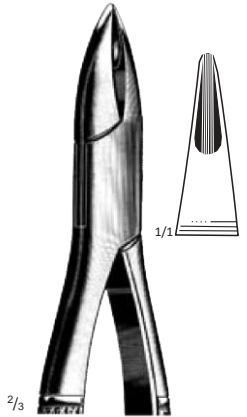

1A
Henahan
M30-245-11
For Upper Incisors

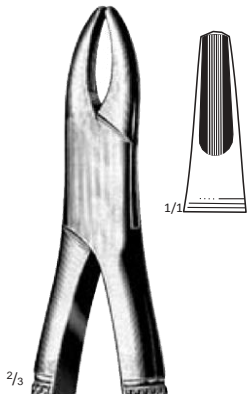

1B
Normal
M30-249-12
For Upper Front Roots

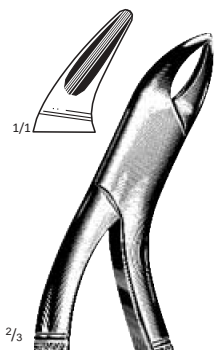

3
Milwaukee
M30-247-03
For Lower Bicuspids

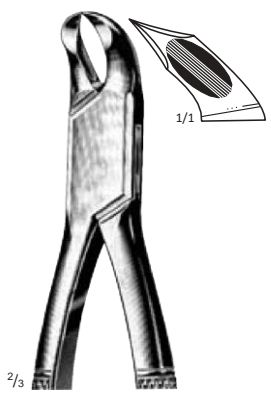

3FS
Woodward
M30-251-03
For Lower Molars for straight handles



3FH
Woodward
M30-253-03
For Lower Molars with hooked handles

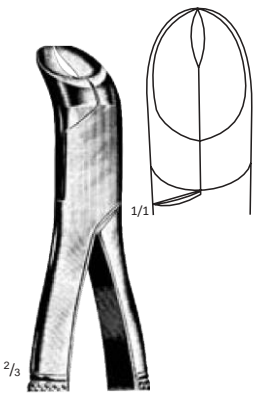

5
Physick
M30-255-05
For Lower Third Molars-either side

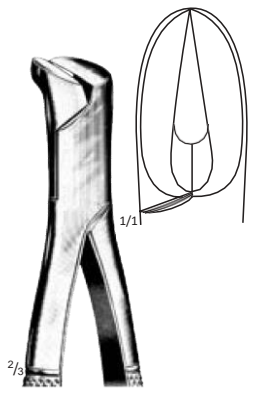

6
M30-257-06
Splitting or Separating Forceps

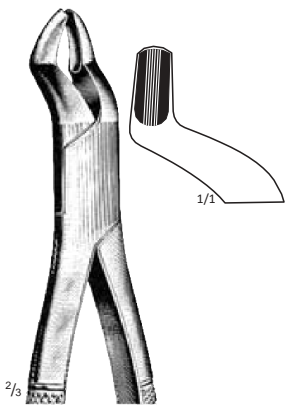

10H
M30-259-10
For Upper Molars with hooked Handles

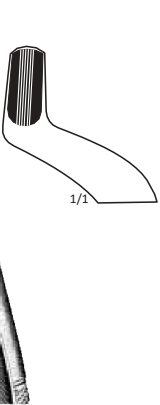

10S
M30-261-10
For Upper Molars with straight handles

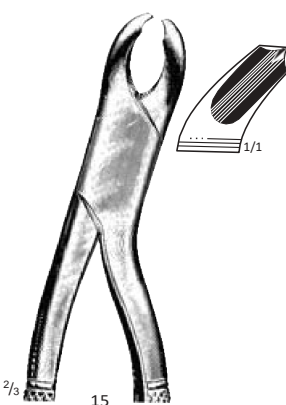

15
Harris
M30-263-15
For Lower Molars for either-side with hooked handles

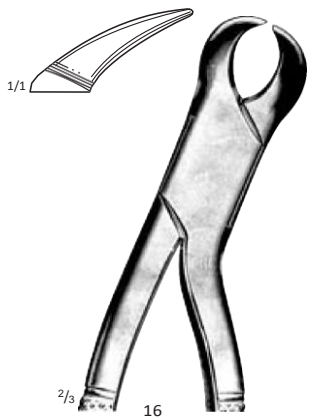

16
M30-265-16
For Lower Molars

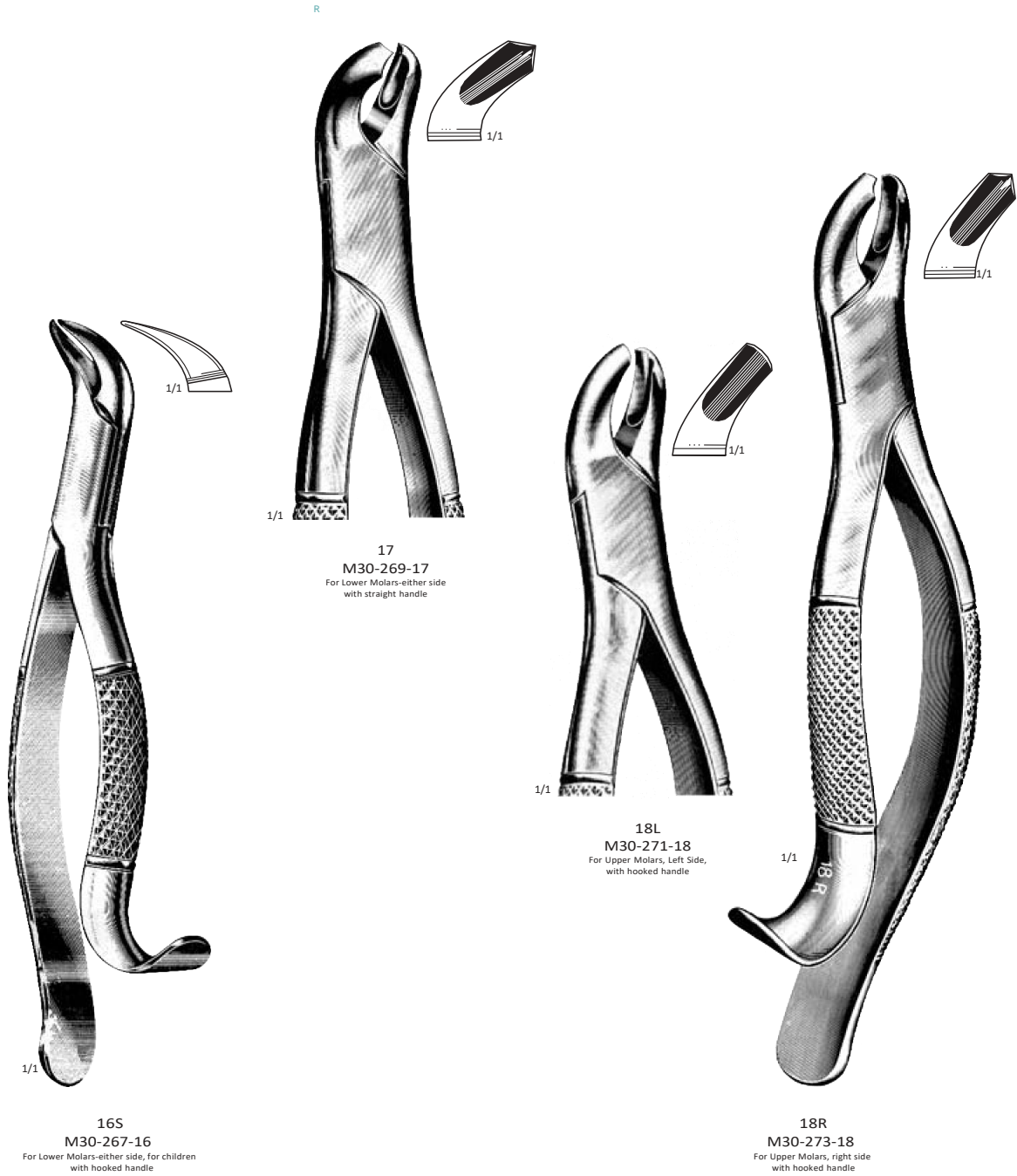

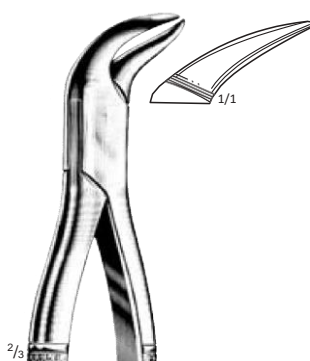

23
M30-275-23
 For Lower Molars-either side
 with straight handle

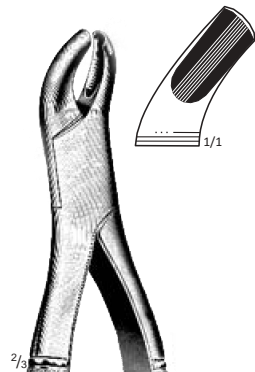

24
M30-277-24
 For Upper Molars-either side
 hooked handle

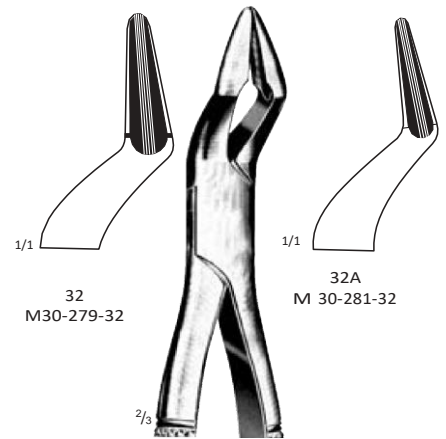

32
M30-279-32
 For Upper Molars and Bicuspid
 with straight handle

32A
Parmly
M30-281-32
 For Upper Molars and Bicuspid
 with straight handle

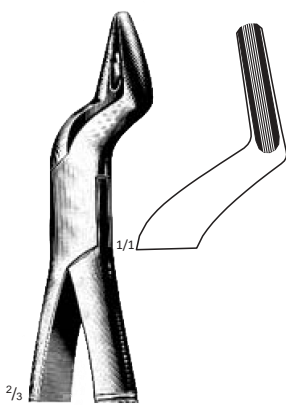

35
M30-283-35
 For Upper Roots-either side
 with straight handle

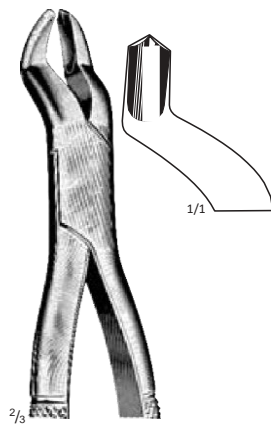

53L
M30-285-53
 For Upper Molars, Left side, with
 straight handle

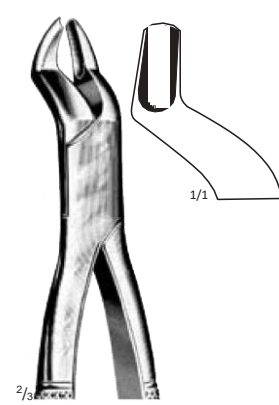

53R
M30-287-53
 For Upper Molars, right side, with
 straight handle

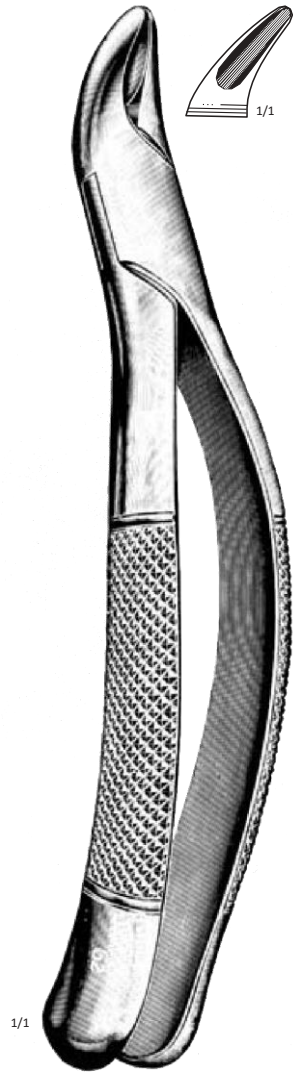

1/1
62
M30-289-62
Universal Forceps, For Upper Teeth and Roots,
For Children, straight handle

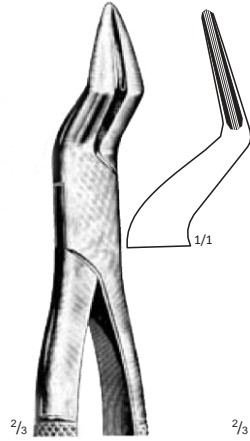
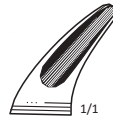

65
M30-291-65
For Upper Incisors and Roots
Straight handle

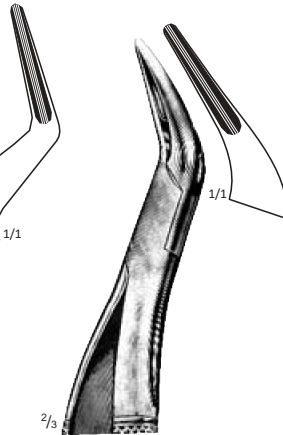

69
M30-293-69
For Fragments and Small Roots, upper
and lower straight handle

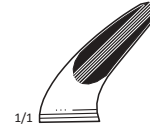

85
M30-295-85
For Lower Molars, Cuspids
and Bicuspid
with hooked handle



Thomas



85A
M30-297-85
For Lower Molars, Cuspids
and Bicuspid
with hooked handle

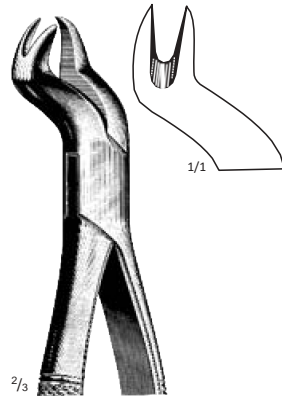

88L
M30-299-88
For Left Upper Molars, with
straight handle

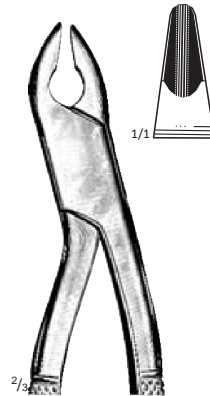

99A
Kells
M30-301-99
For Upper Bicuspid, and Incisors
with hooked handle

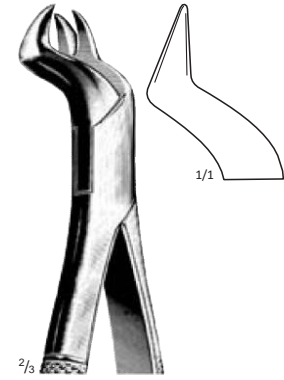

88R
M30-303-88
For Right Upper Molars, with
straight handle

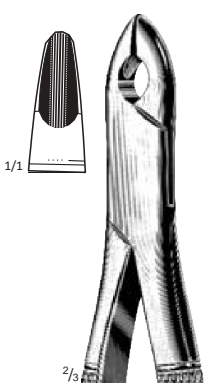

**99C
Kells**
M30-305-99
For Upper Bicuspids, and Incisors
with straight handle

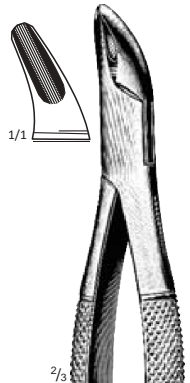

**101
Hull**
M30-307-101
Universal Forceps for Bicuspids,
and Milk-Teeth, straight handle

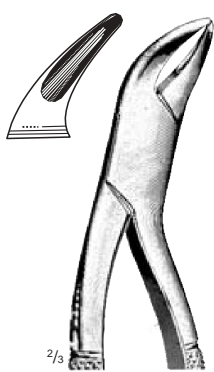

103
M30-309-03
For Lower Bicuspids, Incisors and Roots-either
side hooked handle

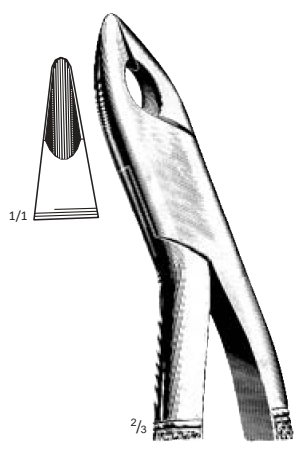

**110
Nevius**
M30-311-10
For Upper Bicuspids and Cuspids
with hooked handle

M30-313-01
For Upper Bicuspids and Cuspids
with straight handle

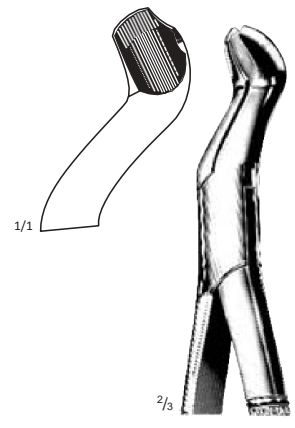

**121
Felsch**
M30-315-21
For Upper Wisdoms with
straight handle

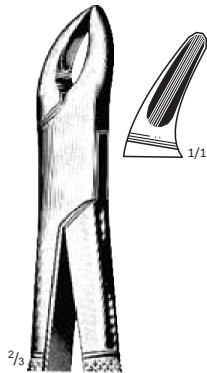

150
Cryer
M30-317-50
For Upper Bicuspids Incisors and
Roots with straight handles

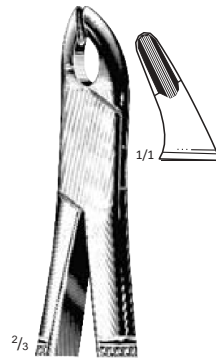

150A
Cryer
M30-319-50
For Upper Bicuspids Incisors and
Roots with straight handle

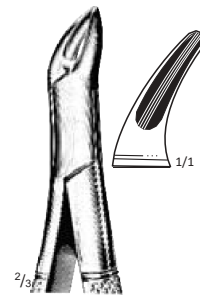

150S
Cryer
M30-321-50
For Upper Bicuspids Incisors and
Roots with straight handle

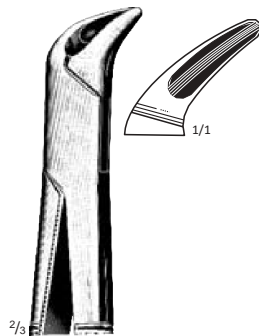

151
Cryer
M30-323-51
For Upper Bicuspids Incisors and
Roots with straight handle

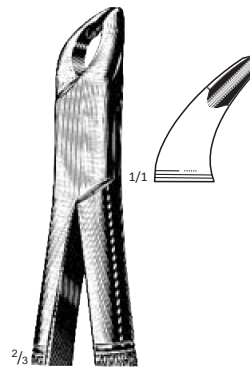

151A
Cryer
M30-325-51
For Upper Bicuspids Incisors and
Roots with straight handle

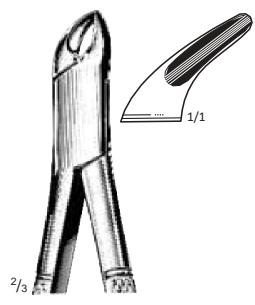

151S
Cryer
M30-327-51
For Lower Bicuspid Incisors and
Roots with straight handle

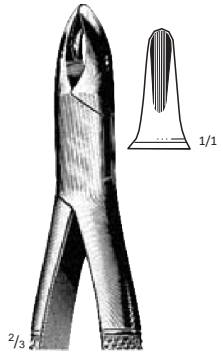

201
M30-329-01
For Upper Bicuspid Cuspids and Incisors
with straight handle

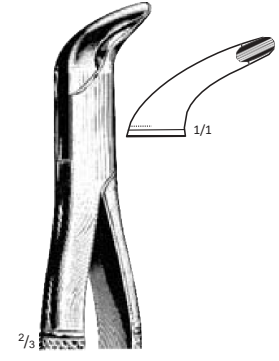

203
M30-331-03
For Lower Bicuspid and Roots Incisors
with straight handle

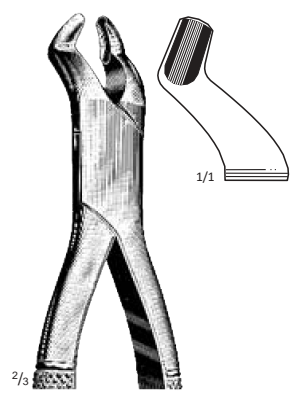

210H
M30-333-10
For Upper Wisdoms-either side
with hooked handle

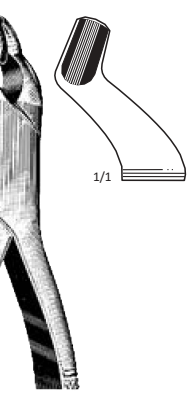

210S
M30-335-10
For Upper Wisdoms-either side
with straight handle

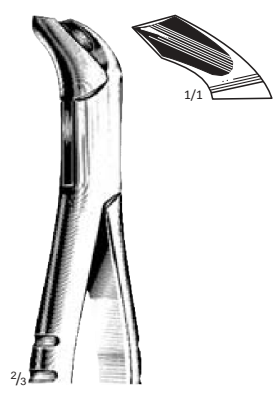

217
M30-337-17
For Lower Molars-either side
with straight handle

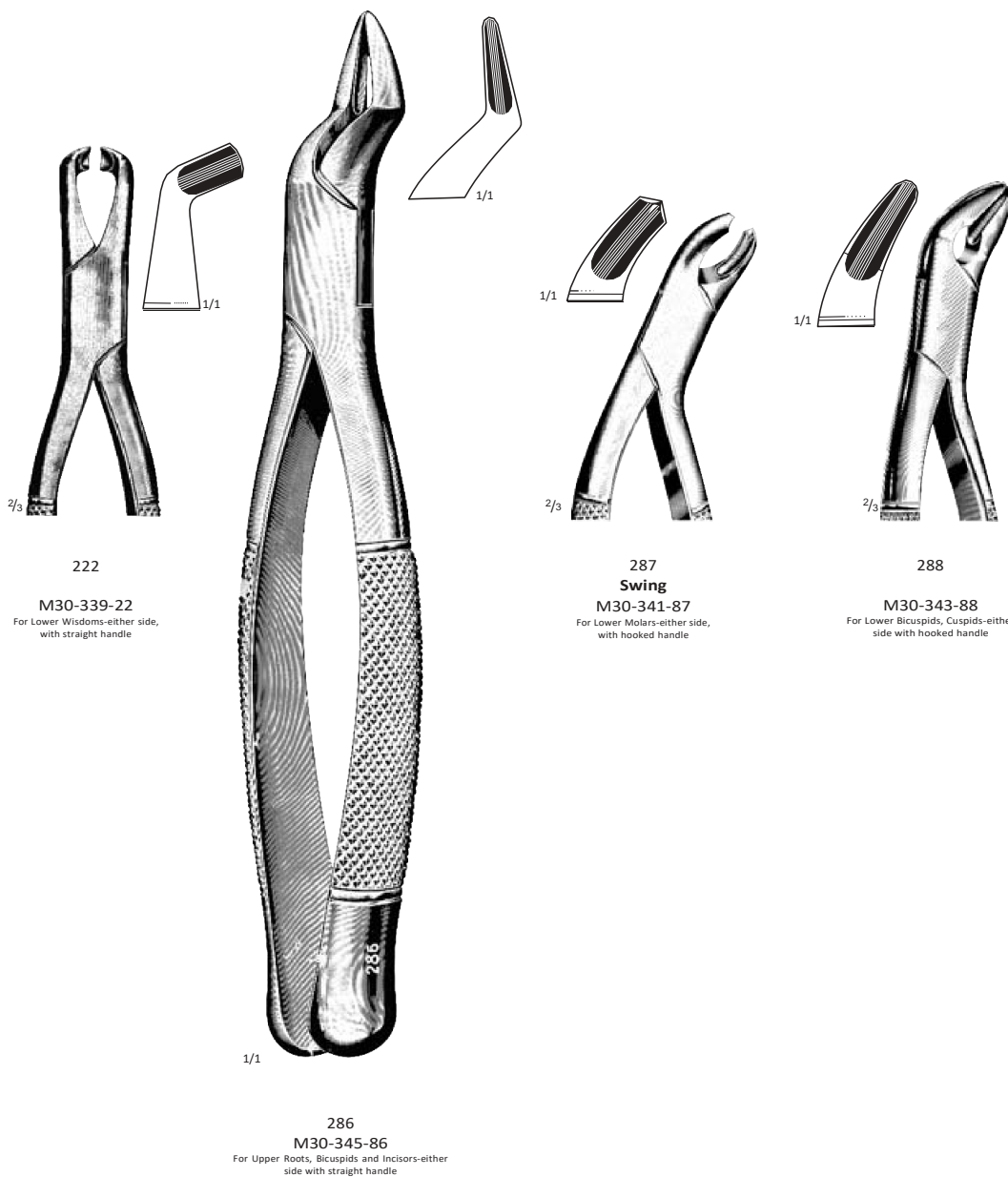

Root Fragment Forceps



Witzel
M30-347-00
Universal Pattern for Upper Teeth

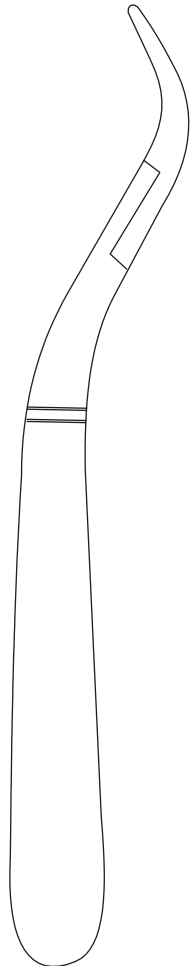

Witzel
M30-349-00
Universal Pattern for Upper Teeth

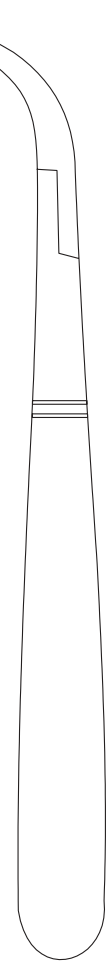

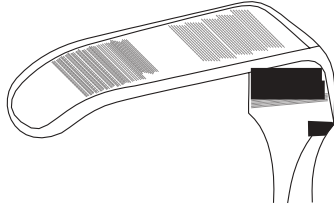

7

RETRACTORS



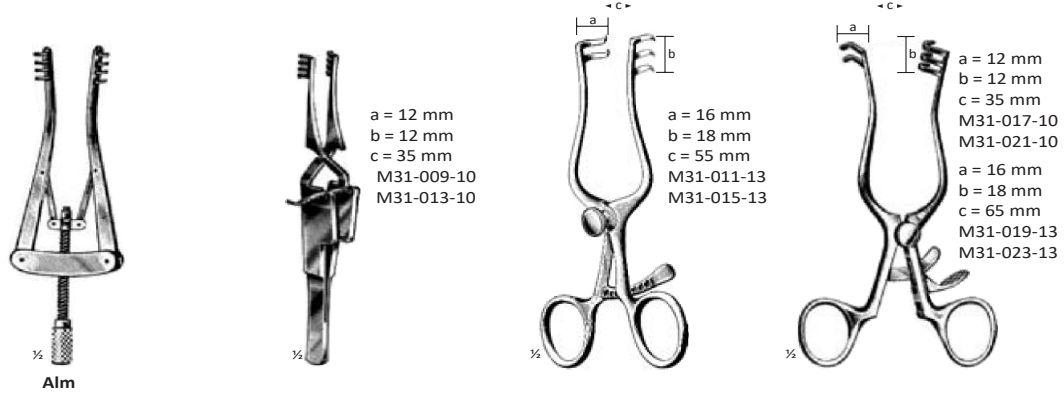

cm	in	Sharp	Blunt	Sharp	Blunt	Sharp	Blunt	Sharp	Blunt
7	2 3/4	M31-001-07	M31-003-07						
10	4	M31-001-10	M31-003-10	M31-005-10	M31-007-10	M31-009-10	M31-013-10	M31-017-10	M31-021-10
13	5					M31-011-13	M31-015-13	M31-019-13	M31-023-13

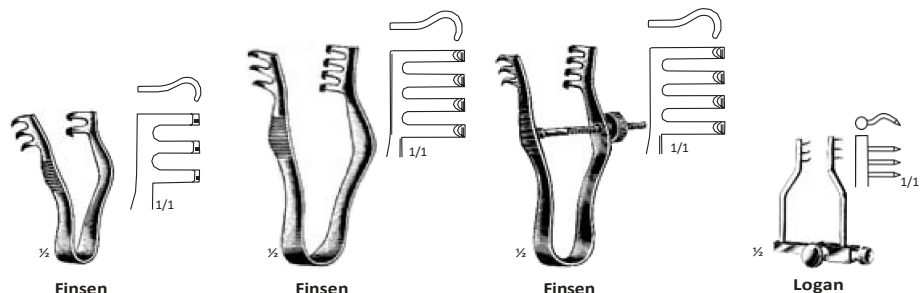

Sharp	Blunt	Sharp	Blunt	Sharp	Blunt	Sharp
5 cm / 2"	5 cm / 2"	7 cm / 2 3/4"	7 cm / 2 3/4"	7 cm / 2 3/4"	7 cm / 2 3/4"	4 cm / 1 1/2"
M31-025-05	M31-027-05	M31-029-07	M31-031-07	M31-033-07	M31-035-07	M31-037-04

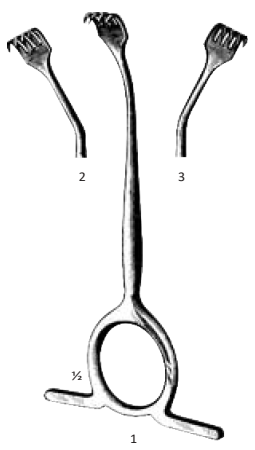

	Sharp	Blunt	
1	M31-039-03	M31-045-04	M31-051-03
2	M31-041-03	M31-047-04	M31-053-03
3	M31-043-03	M31-049-04	M31-055-03

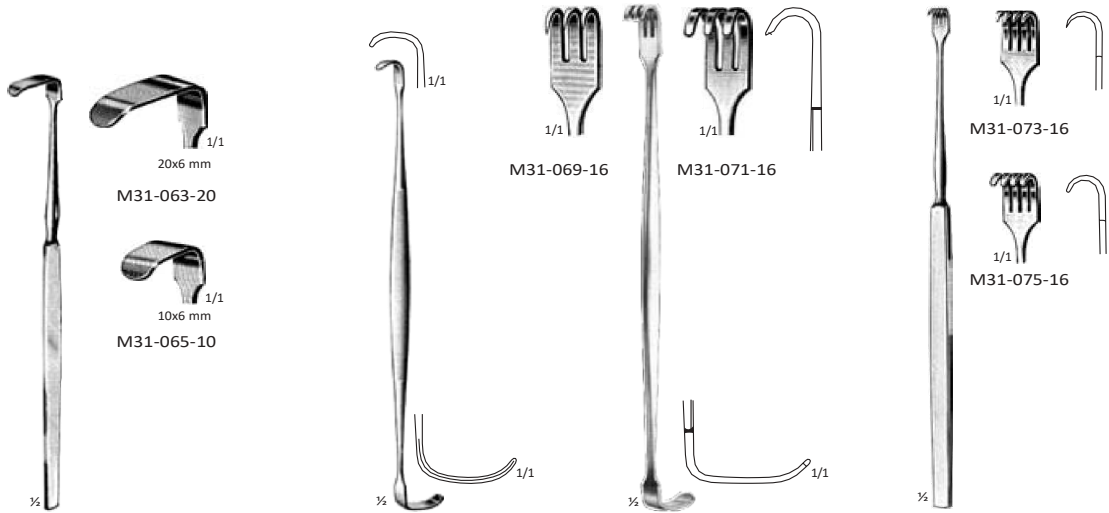

Senn-Green
15 cm / 6"

Ragnell-Davis
14 cm / 5½"
M31-067-14

Senn-Mueller
16 cm / 6¼"

Klapp
16 cm / 6¼"

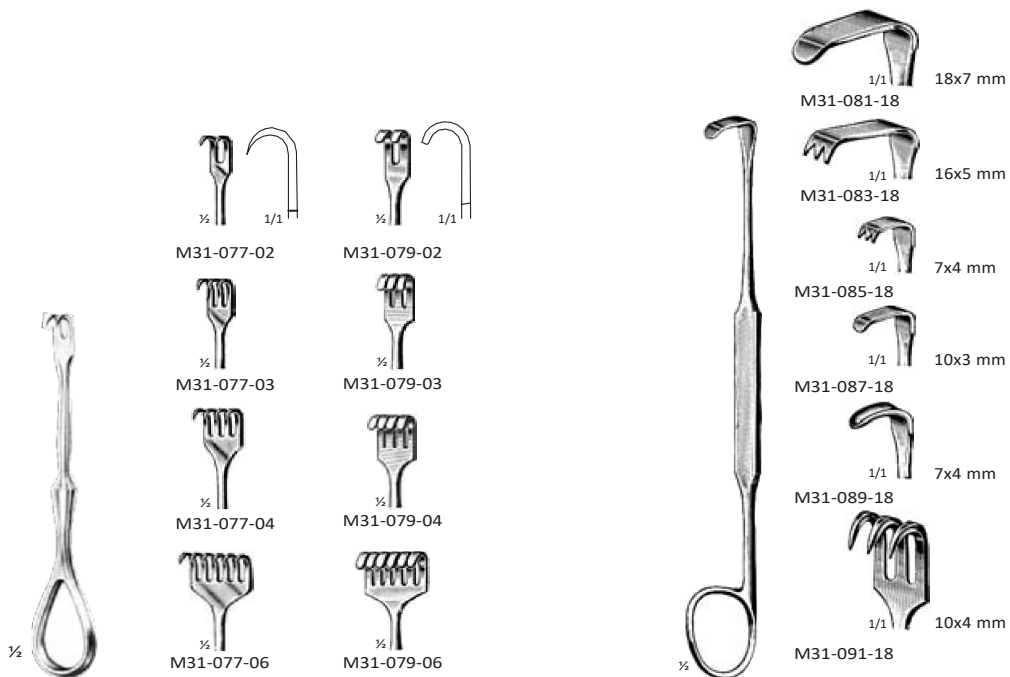

Volkman
11.5 cm / 4½"

Meyerding
18 cm / 7"

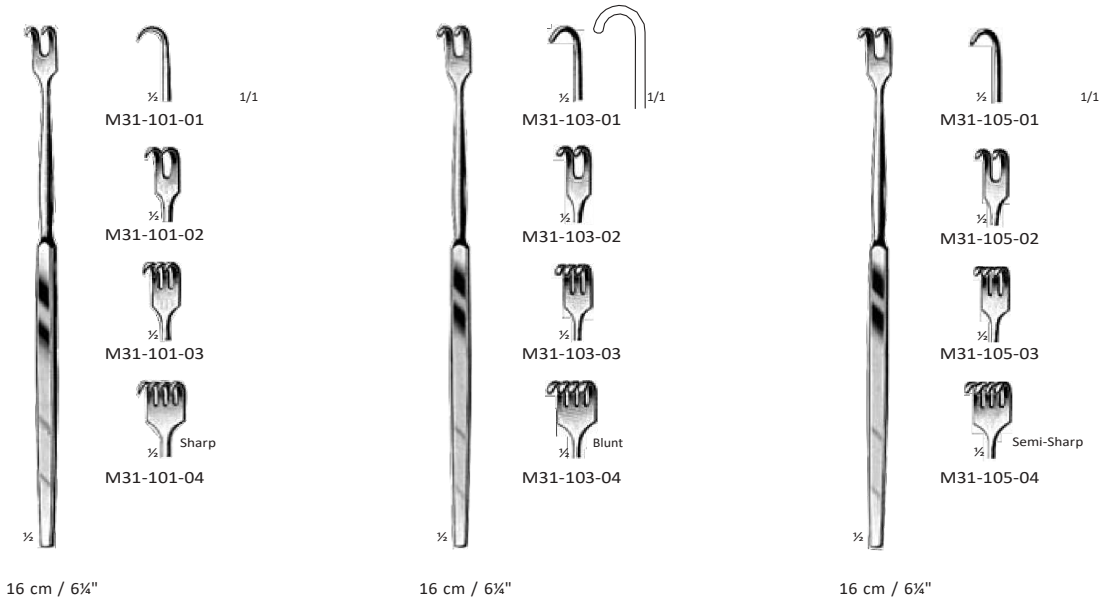
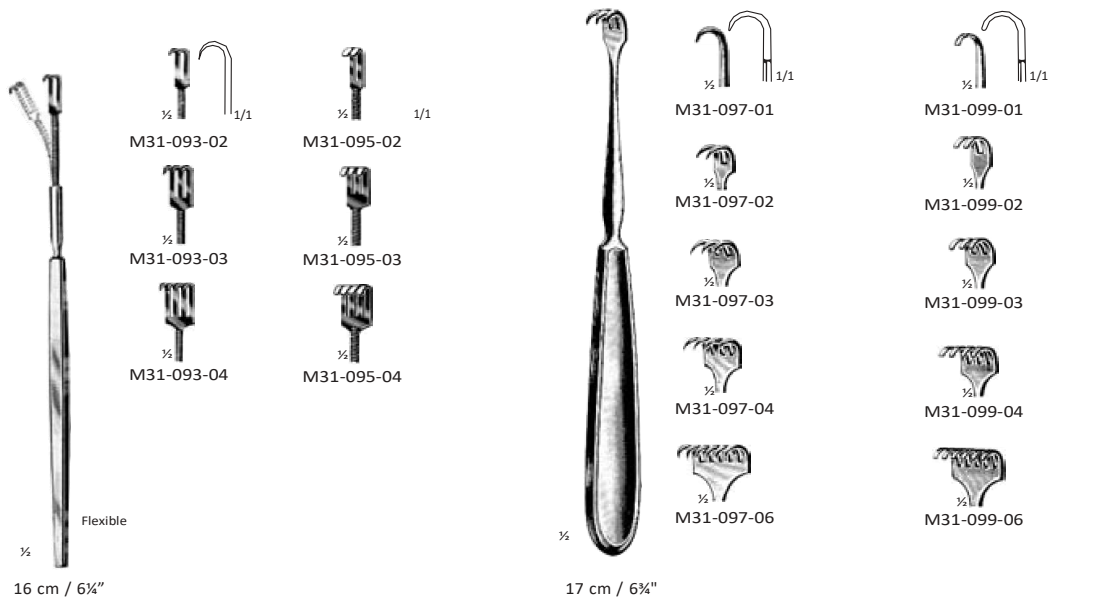

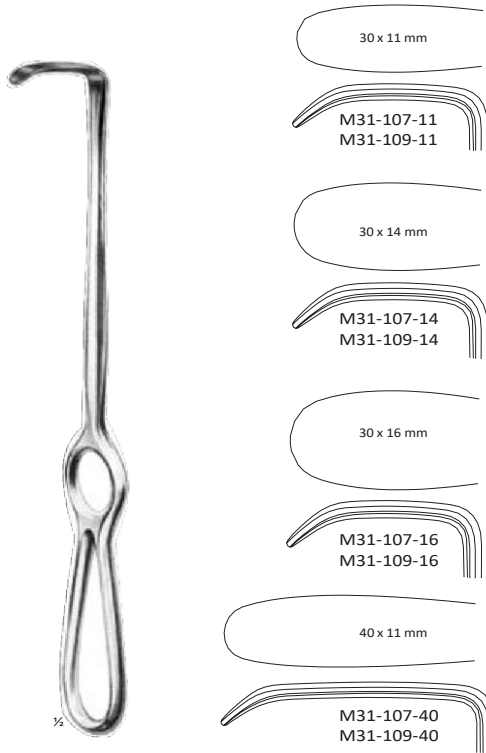

Langenbeck
21 cm / 8¼"
M31-107-00

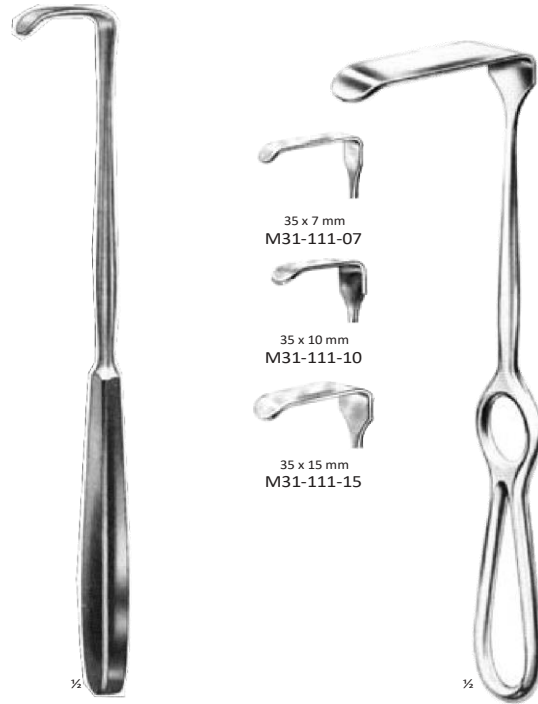

Langenbeck
21 cm / 8¼"

Langenbeck
22 cm / 8½"
M31-111-22

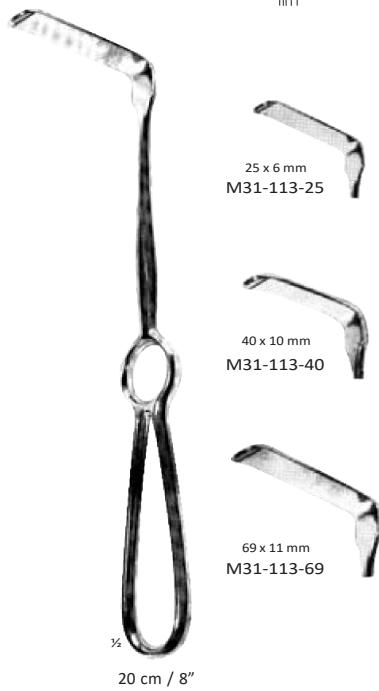

20 cm / 8"

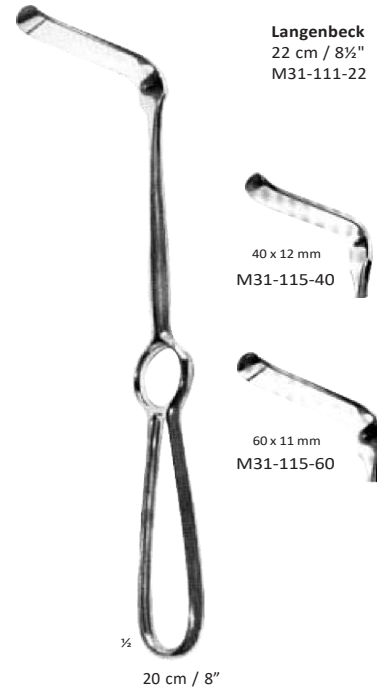

20 cm / 8"

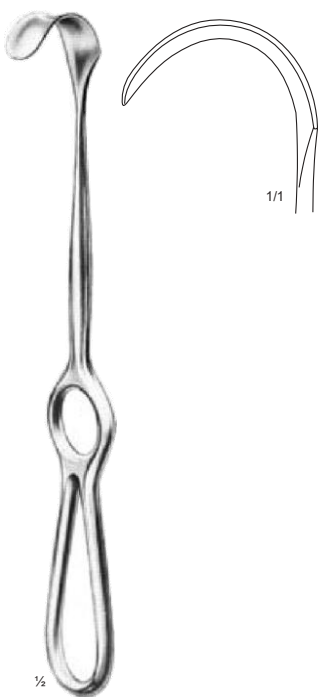

Kocher
22 cm / 8 3/4"
40 x 10 mm
M31-117-10
40 x 15 mm
M31-119-15

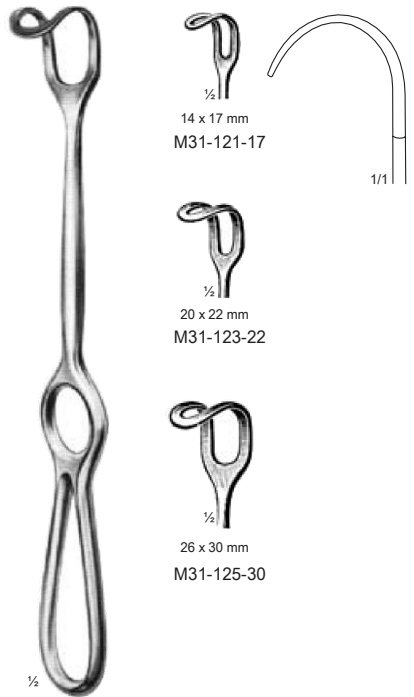

Middeldorpf

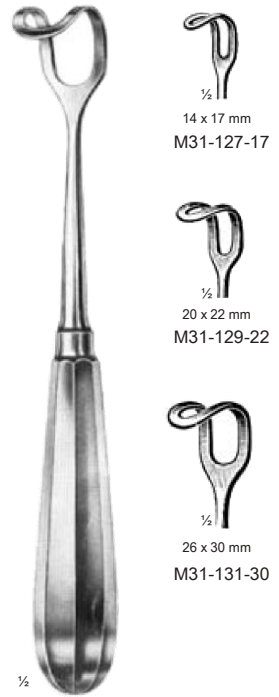

Middeldorpf



M31-133-01



M31-135-01



Shann
M31-137-01

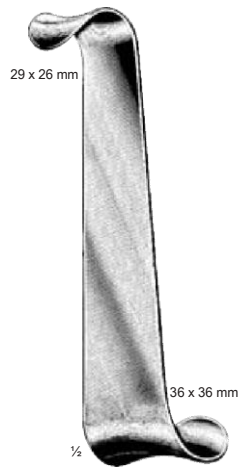

Roux Magnus
M31-139-01

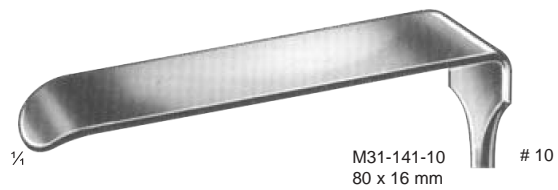
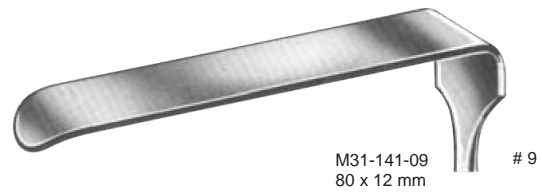
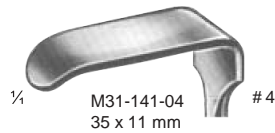
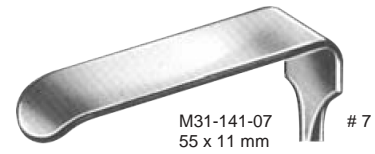
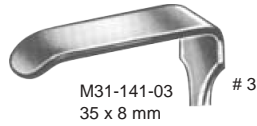
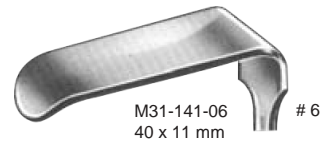
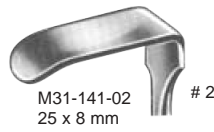
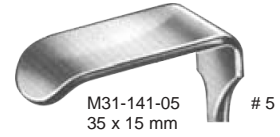
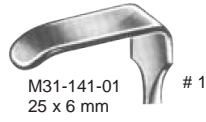

½
Kocher-Langenbeck
21.5cm/8 ½"

also available in special sizes

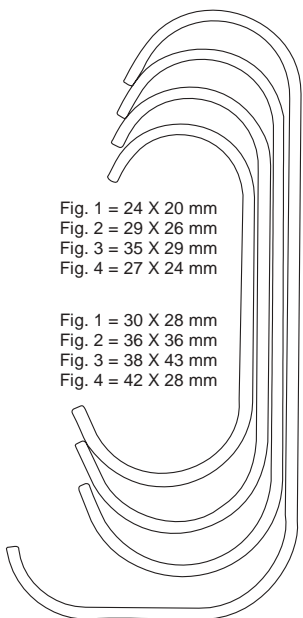
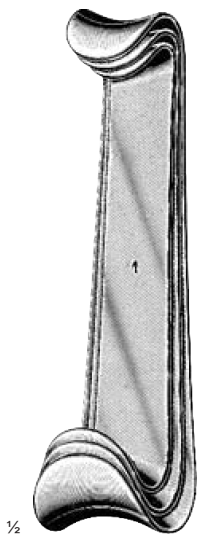

Fig. 1 = 24 X 20 mm
 Fig. 2 = 29 X 26 mm
 Fig. 3 = 35 X 29 mm
 Fig. 4 = 27 X 24 mm

Fig. 1 = 30 X 28 mm
 Fig. 2 = 36 X 36 mm
 Fig. 3 = 38 X 43 mm
 Fig. 4 = 42 X 28 mm

Roux
 M31-143-00 = Set Fig. 1-3
 M31-143-01 = Fig. 1 = 14 cm/5 1/2"
 M31-143-02 = Fig. 2 = 15 cm/6"
 M31-143-03 = Fig. 3 = 17 cm/6 3/4"
 M31-143-04 = Fig. 4 = 18 cm/7"

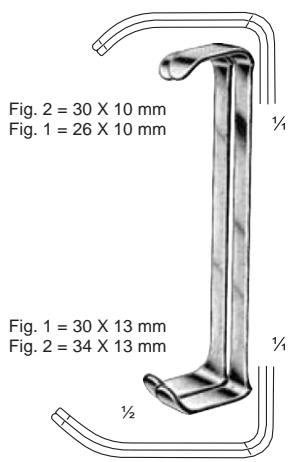

Fig. 2 = 30 X 10 mm
 Fig. 1 = 26 X 10 mm

Fig. 1 = 30 X 13 mm
 Fig. 2 = 34 X 13 mm

Farabeuf
 M31-145-00 = Set
 M31-145-01 = Fig. 1
 M31-145-02 = Fig. 2
 12 cm/4 3/4"

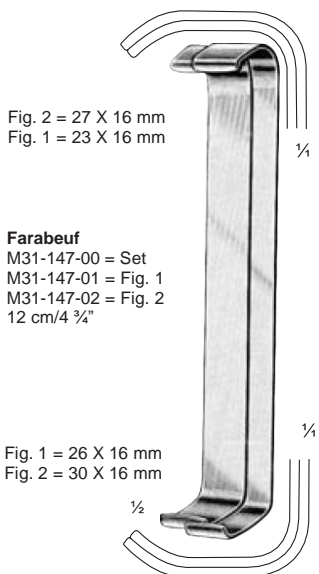
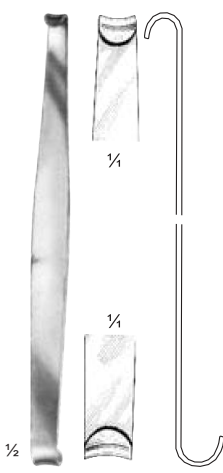

Fig. 2 = 27 X 16 mm
 Fig. 1 = 23 X 16 mm

Farabeuf
 M31-147-00 = Set
 M31-147-01 = Fig. 1
 M31-147-02 = Fig. 2
 12 cm/4 3/4"

Fig. 1 = 26 X 16 mm
 Fig. 2 = 30 X 16 mm



Mini-Roux
 M31-149-06

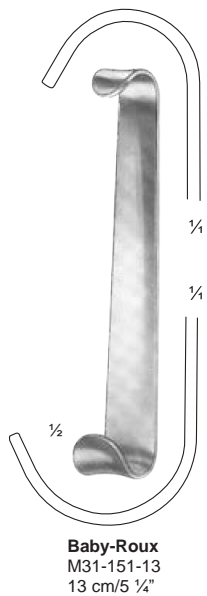

Baby-Roux
 M31-151-13
 13 cm/5 1/4"

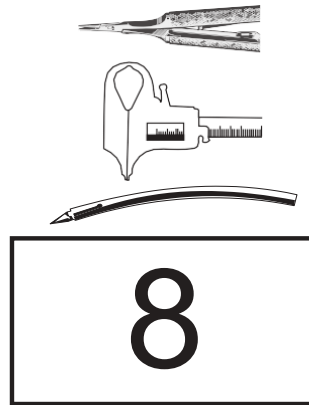

SUTURES, SUCTION TUBES &
MEASURING TOOLS

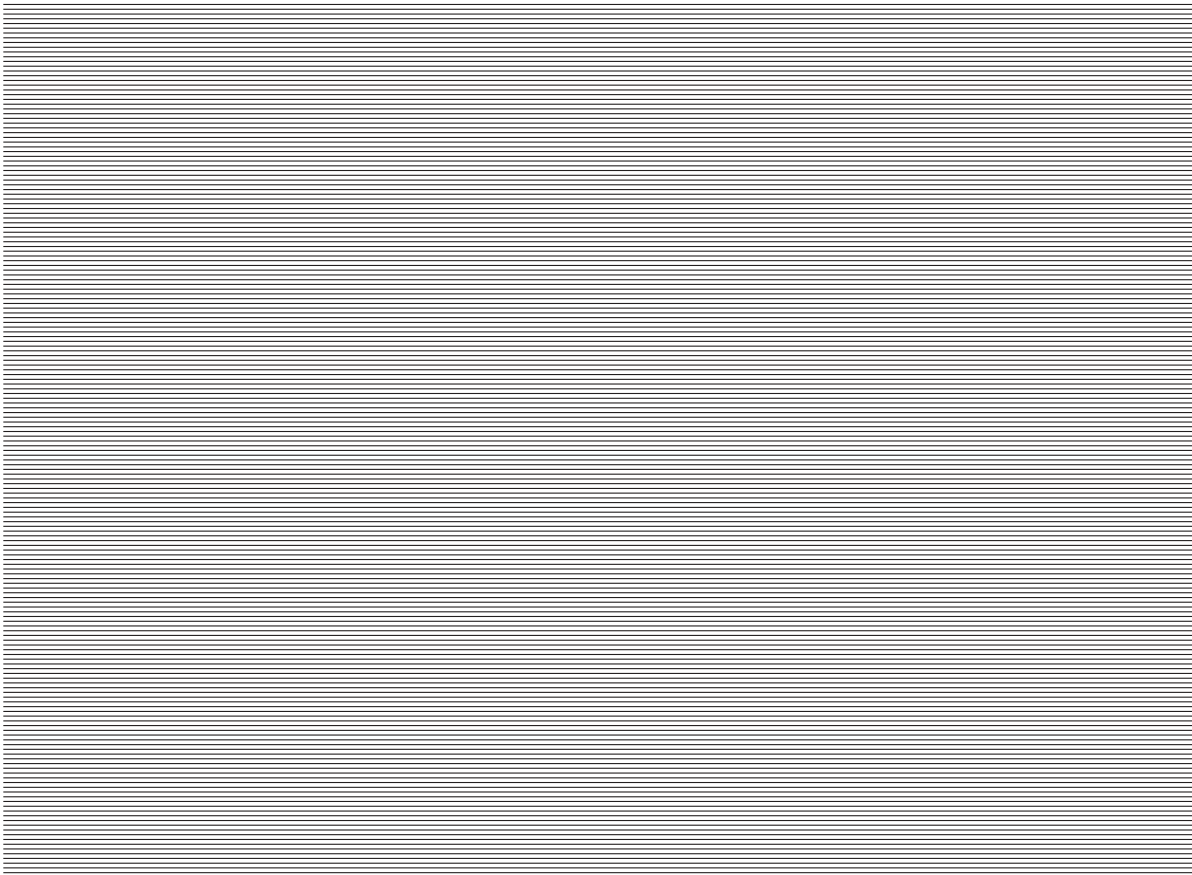



Reverdin

Reverdin

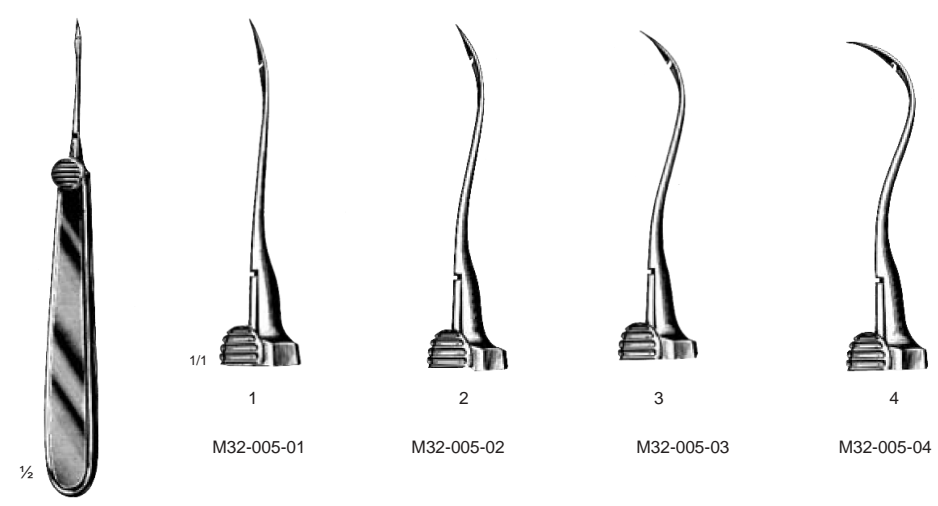

Reverdin
14 cm / 5¹/₂"



Mayo-Hegar

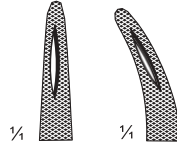

cm	in.	straight	curved
14	5 ½	M32-007-14	
16	6 ¼	M32-007-16	M32-009-16
18	7	M32-007-18	M32-009-18
20	8	M32-007-20	M32-009-20
24	9 ½	M32-007-24	M32-009-24
26	10 ¼	M32-007-26	M32-009-26
30	12	M32-007-30	

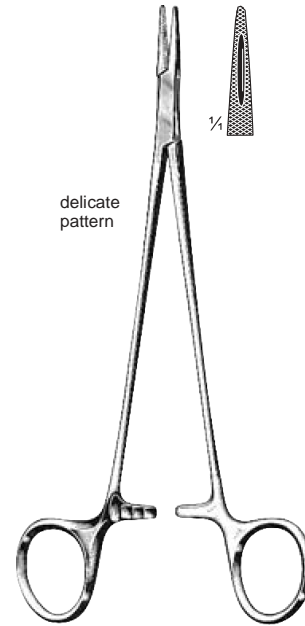

delicate pattern

Mayo-Hegar

M32-011-16 = 16cm/6 ¼"
M32-011-18 = 18cm/7"
M32-011-20 = 30cm/8"

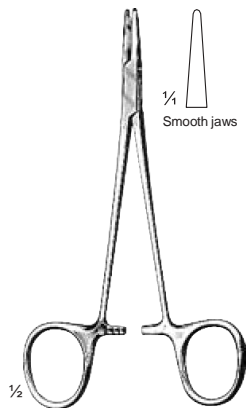

Halsey
M32-013-13
13 cm / 5"

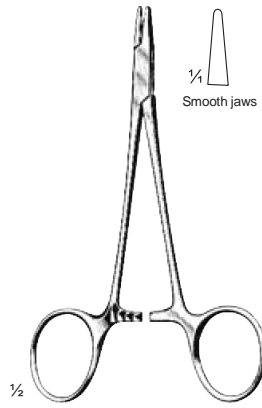

Webster
M32-015-13
13 cm / 5"

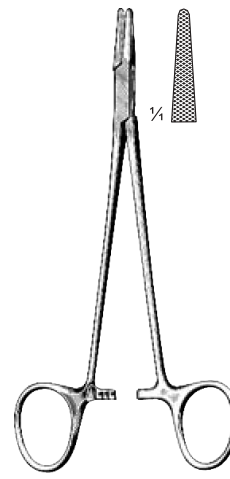

Crile-Murray
M32-017-15
15 cm / 6"

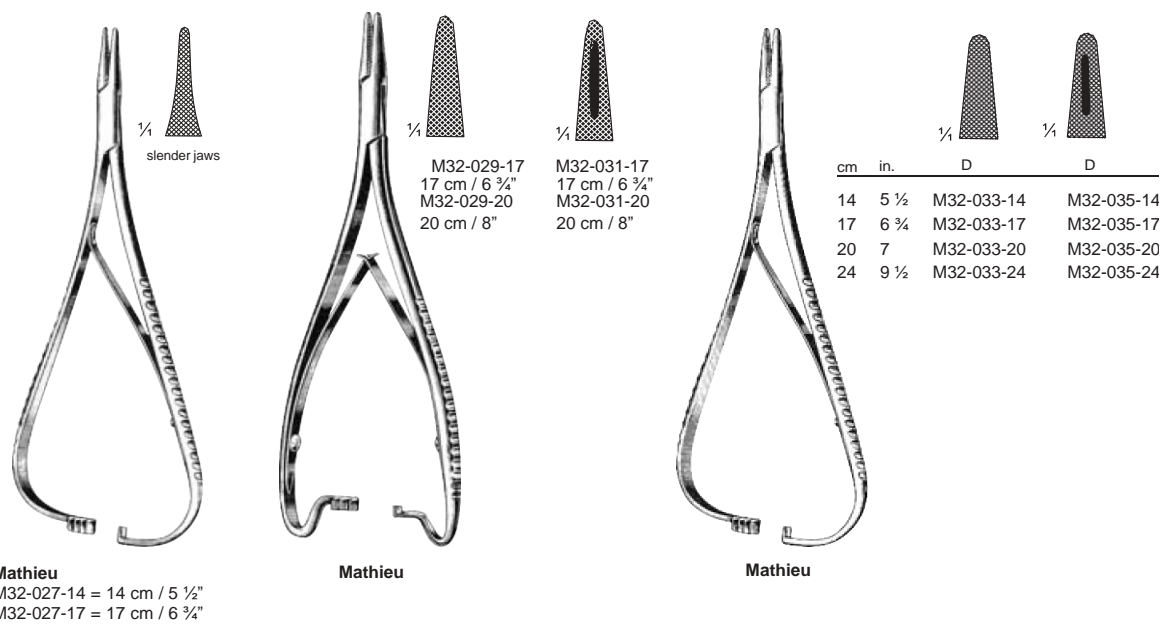
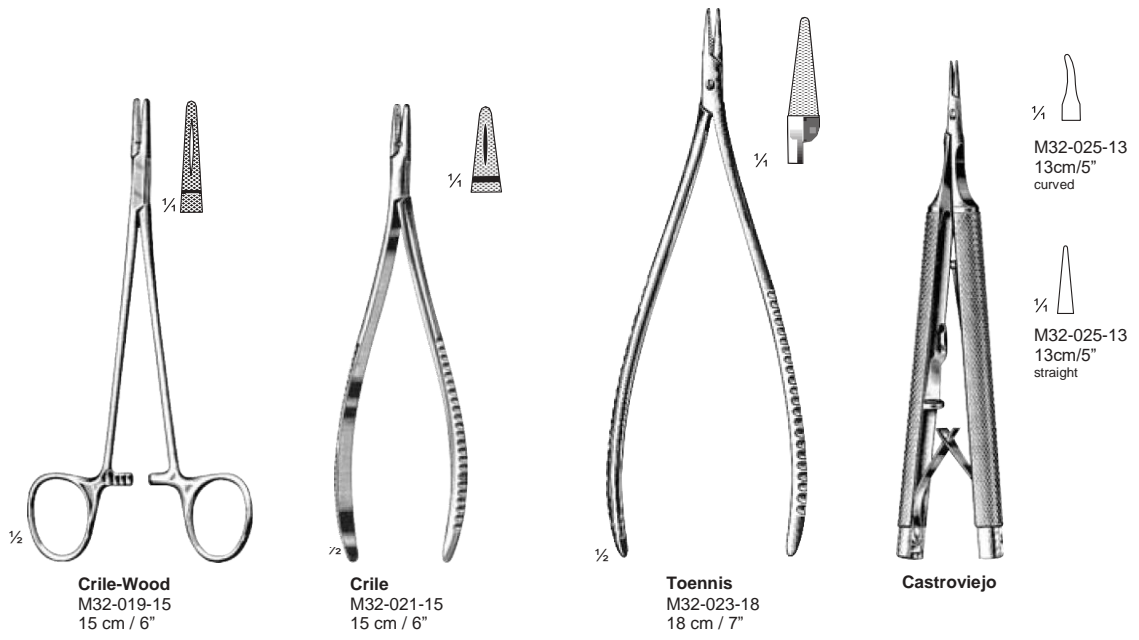

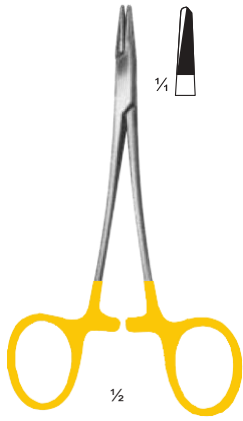

Webster
M32-037-13
13cm/5"



Baumgartner
M32-039-13
13cm/5"



Derf (Halsey)
M32-041-12
12cm/4 3/4"



Derf (Halsey)

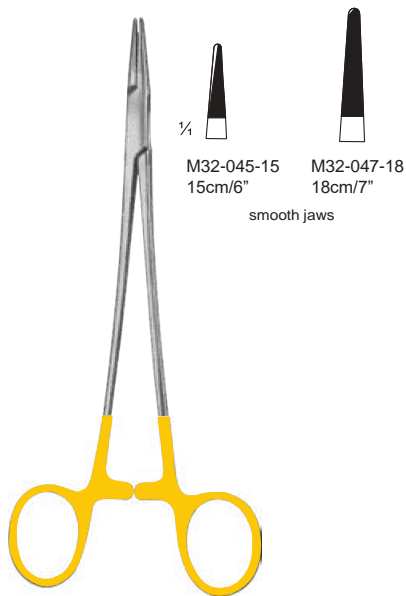

Crile-Wood



New Orleans

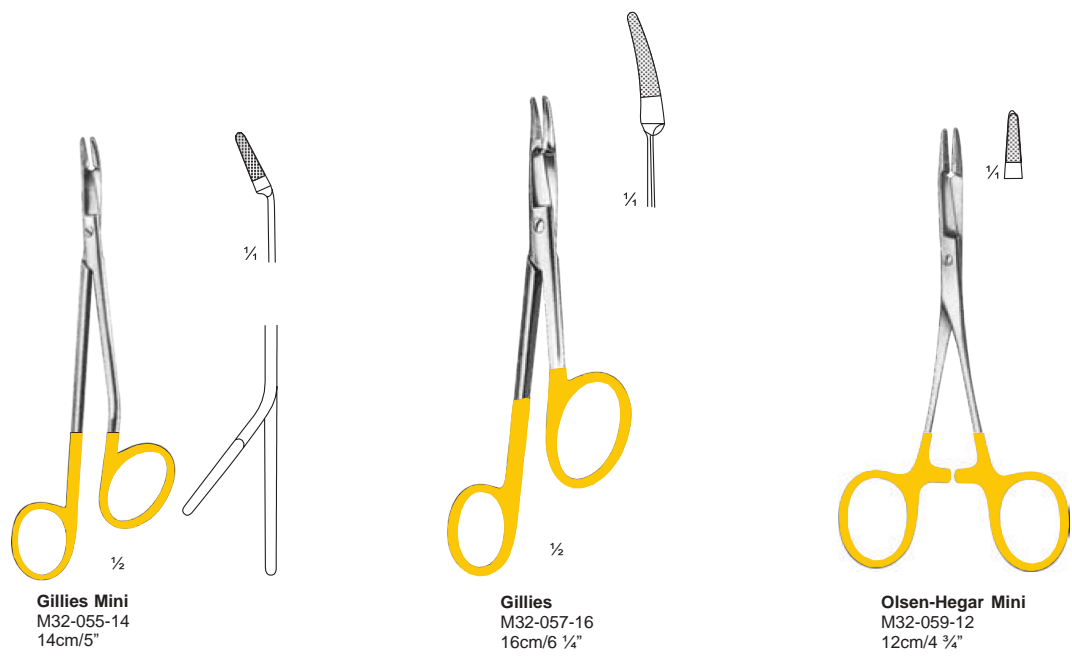
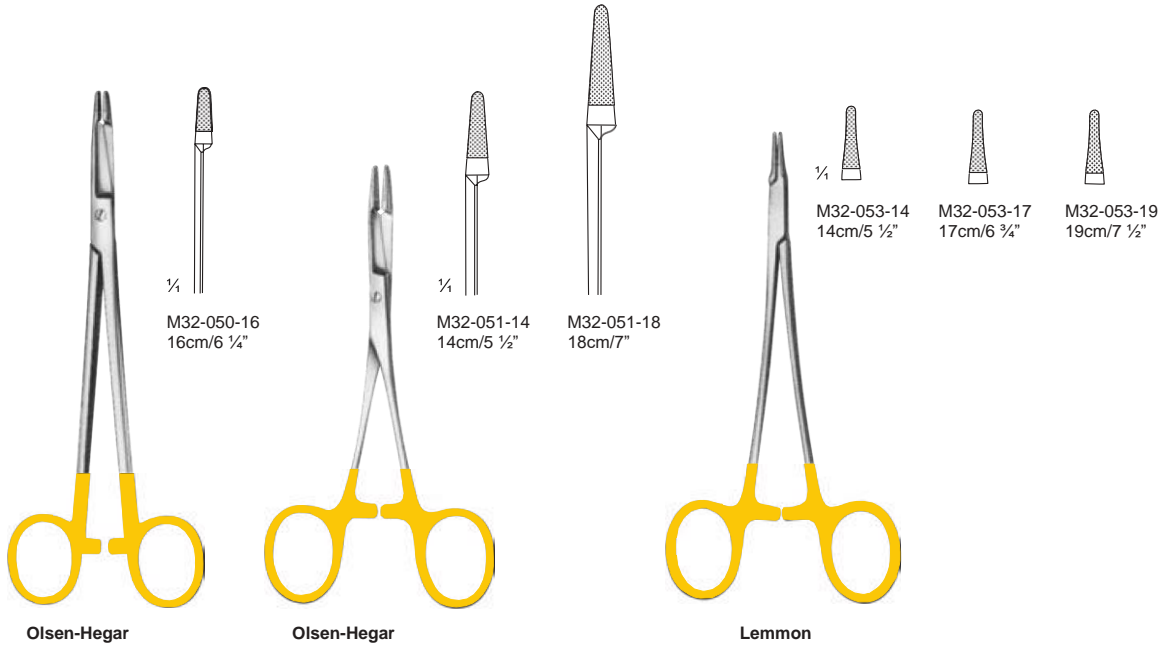

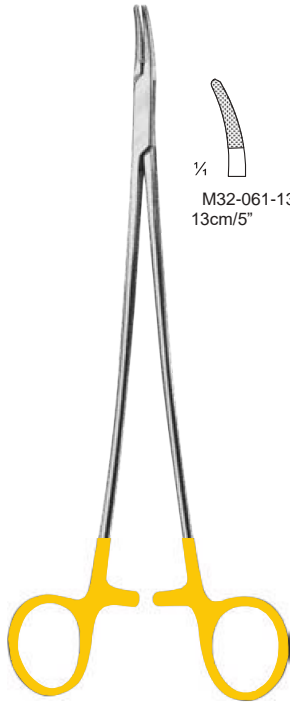

Crile-Wood

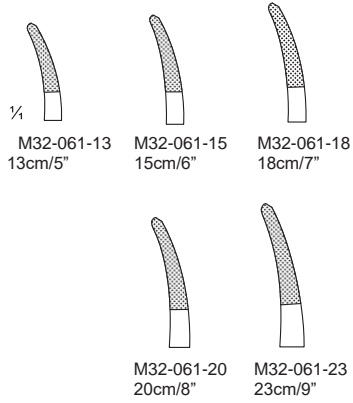

Mayo-Hegar

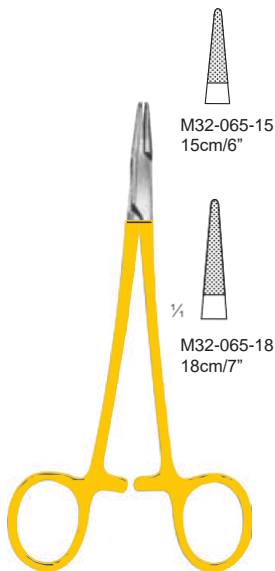
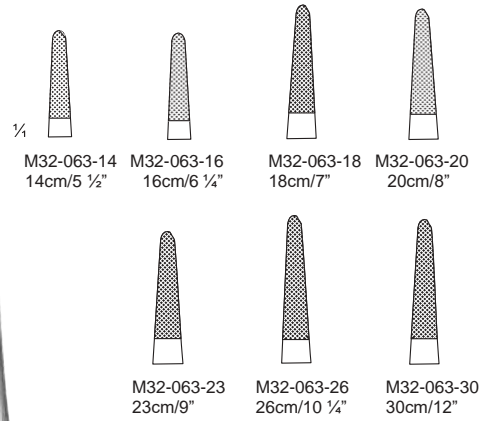

Crile Wood

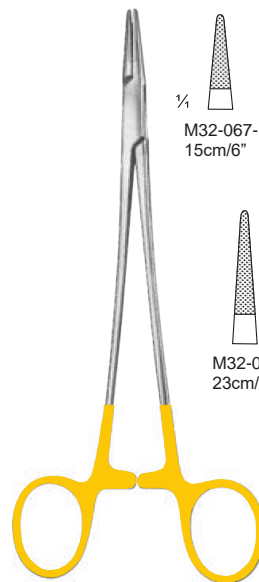

Crile-Wood (Newman)

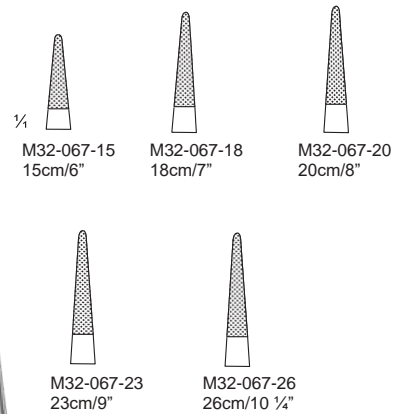

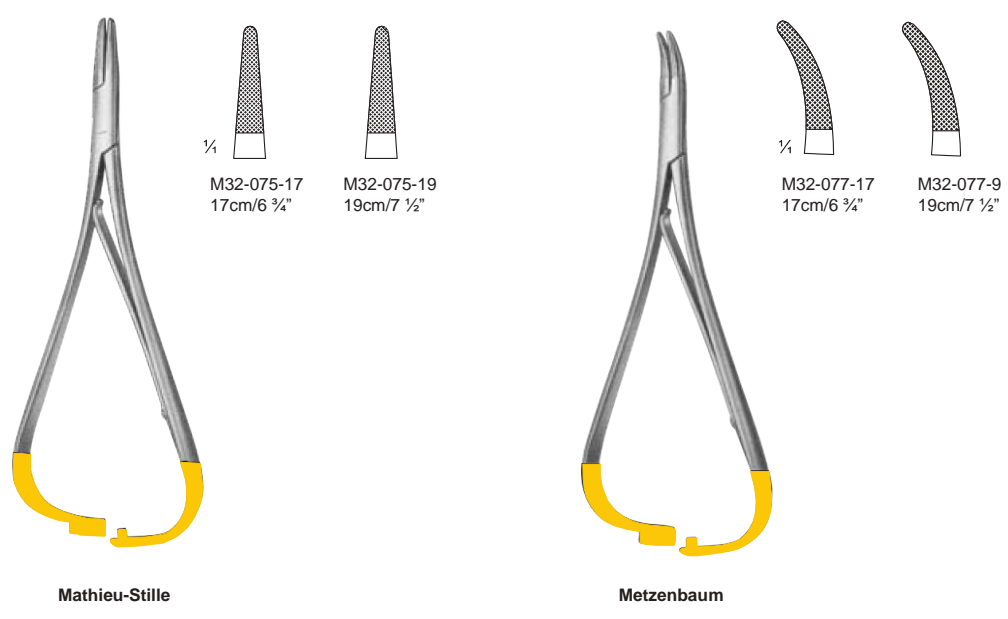
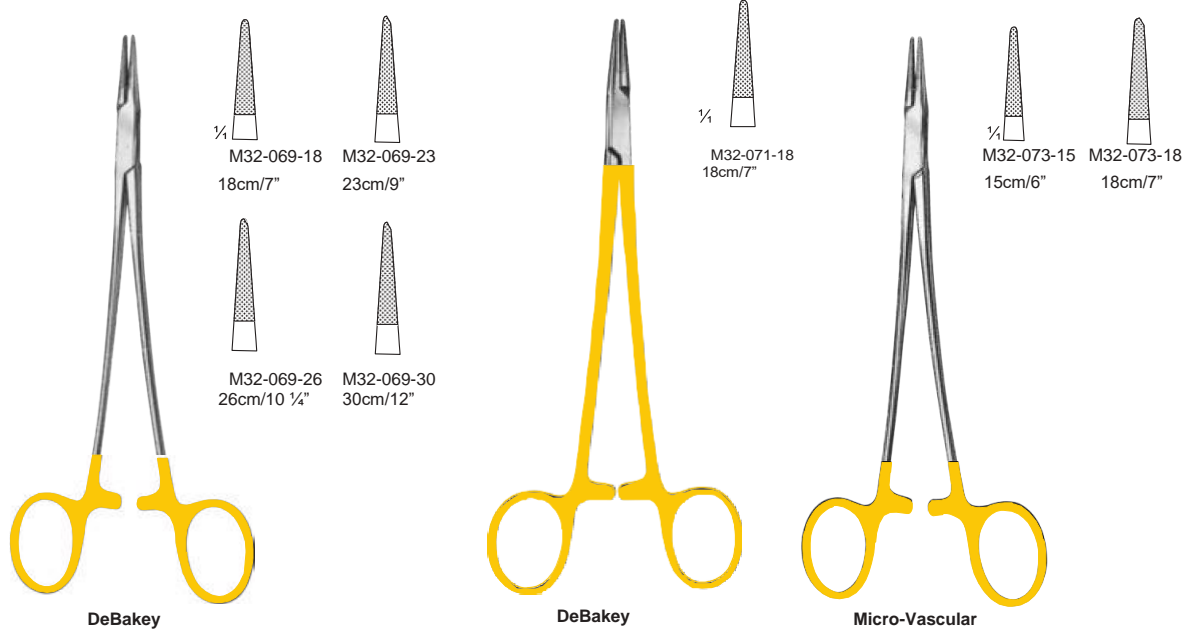



Tönnies

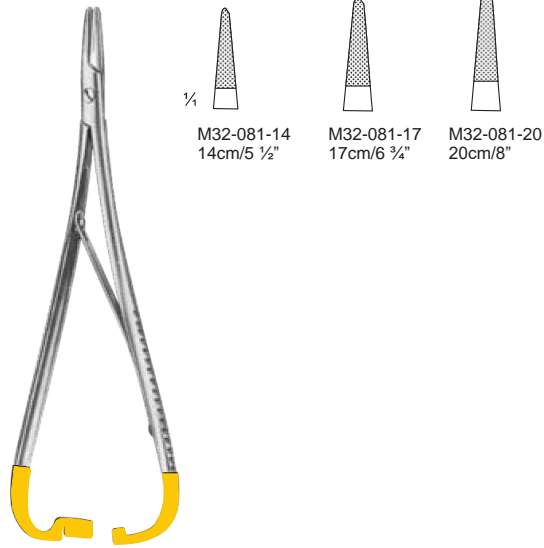

Lichtenberg

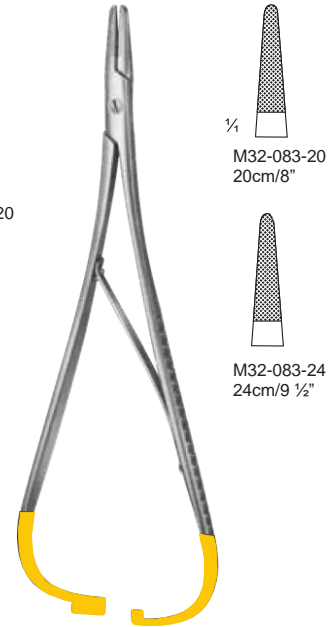

Mathieu

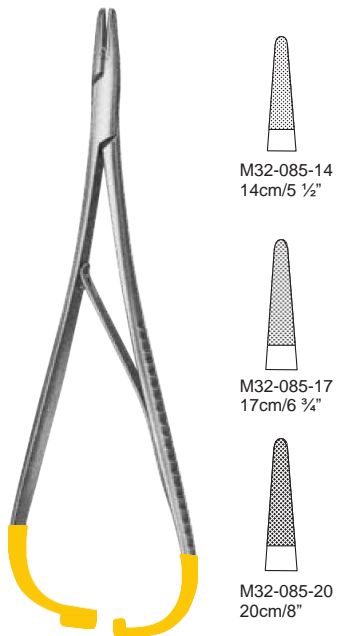

Mathieu

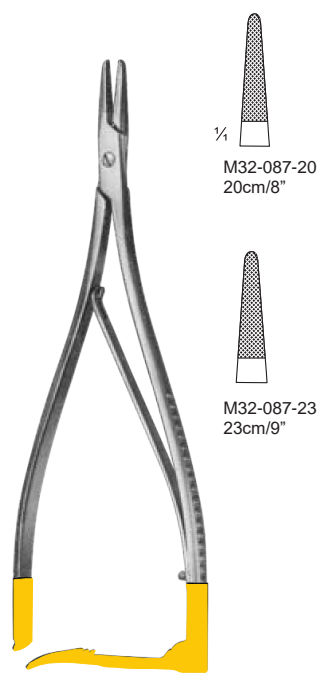

Zweifel

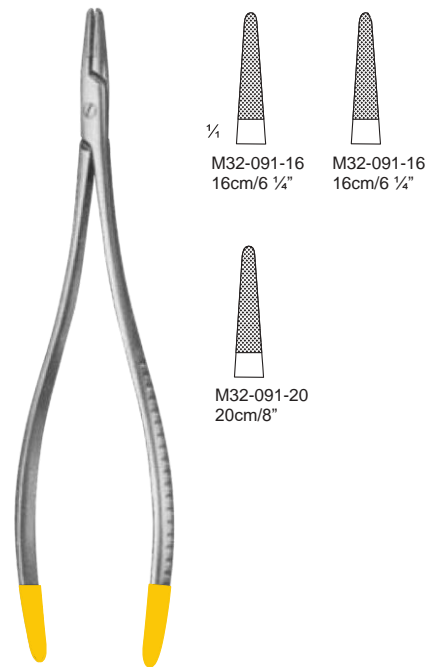

Langenbeck

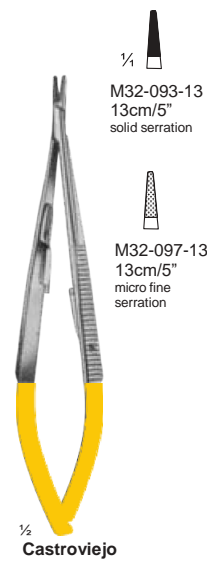

- 1/4
M32-093-13
13cm/5"
solid serration
- 1/4
M32-095-13
13cm/5"
solid serration
- 1/4
M32-097-13
13cm/5"
micro fine serration
- 1/4
M32-099-13
13cm/5"
micro fine serration

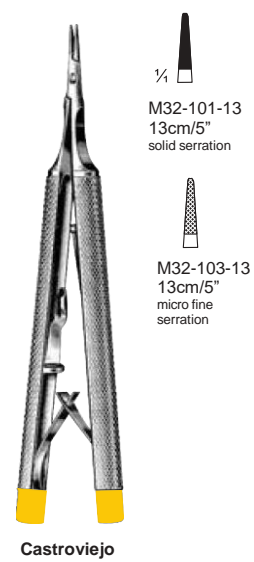

- 1/4
M32-101-13
13cm/5"
solid serration
- 1/4
M32-103-13
13cm/5"
micro fine serration

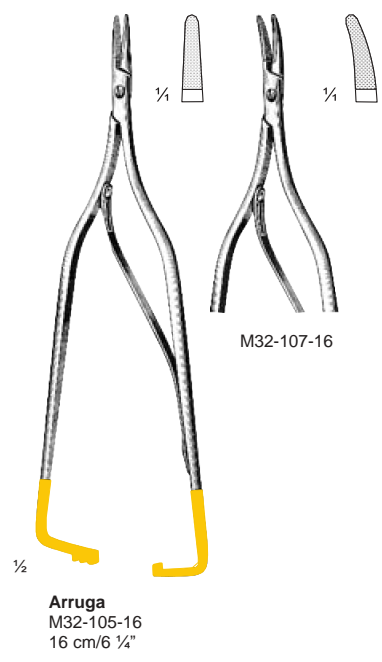

- 1/4
- 1/4



- | | | | | |
|----------------------|------------------------------|------------------------------|------------------------------|------------------------------|
| solid serration | 1/4
M32-109-18
18cm/7" | 1/4
M32-111-18
18cm/7" | 1/4
M32-113-20
20cm/8" | 1/4
M32-115-20
20cm/8" |
| micro fine serration | 1/4
M32-117-18
18cm/7" | 1/4
M32-119-18
18cm/7" | 1/4
M32-121-20
20cm/8" | 1/4
M32-123-20
20cm/8" |



Lichtwitz
1.75 mm ø
M32-125-17



Lichtwitz
2 mm ø M32-
127-22



Pierce
M32-129-3 mmø
M32-129-4 mmø
M32-129-5 mmø

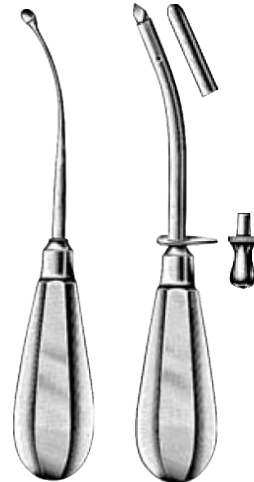

Krause
5.5 mm ø
M32-131-55



Yankauer
M32-132-T



0
M32-133-10



1
M32-133-11



2
M32-133-12



3
M32-133-13

M32-133-15

M32-133-02



Yankauer
M32-133-01

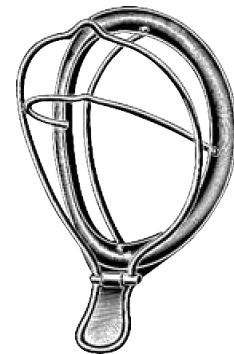

Schimmelbusch
M32-135-01

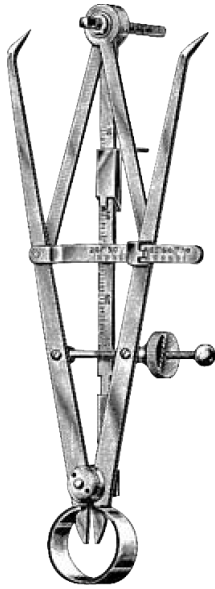

Korkhaus
M32-137-01



18.5 cm / 7 1/4"
M32-139-18

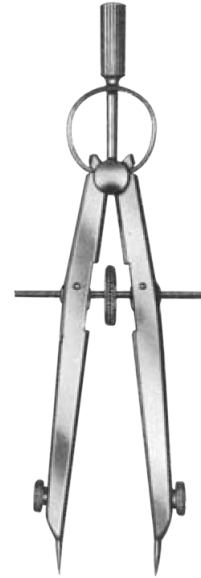

12 cm / 4 3/4"
M32-141-12



M32-143-01

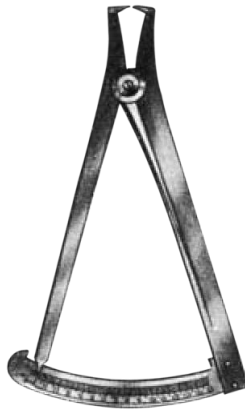

Measuring range 0-15 mm
M32-145-15

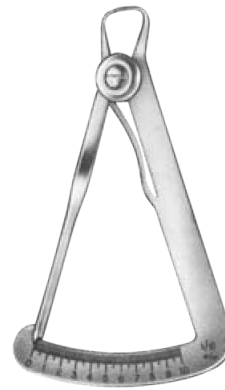

Measuring range 0-10 mm
M32-147-10

M32-137-01	Three dimensional Caliper
M32-139-18	Bow space for orthodontic work
M32-141-12	Deviding Compass
M32-143-01	Bow Compass
M32-145-15	Decimal spring Caliper
M32-147-10	Decimal spring Caliper

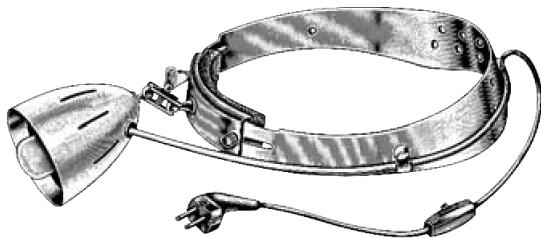

Orion
M32-149-01

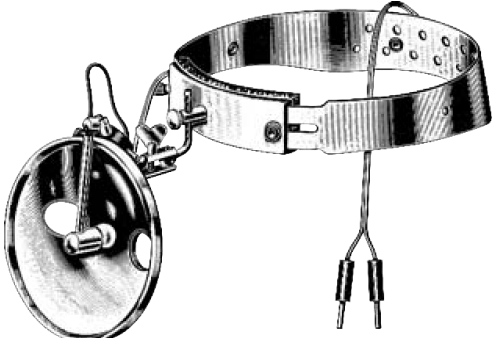

Clar
M32-151-01

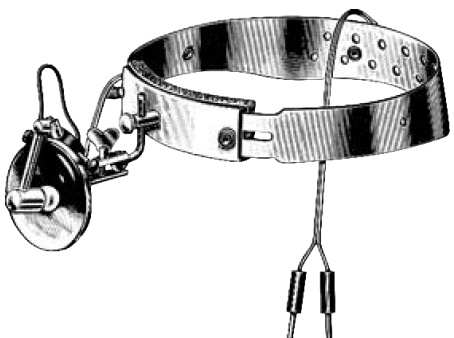

Clar-mini
M32-153-01



11.5 cm / 4½"
M32-155-11



11.5 cm / 4½"
M32-157-11



Boley
M32-159-01

M32-149-01	M32-151-01	Head Lamp
M32-153-01	M32-153-01	Head Lamp
M32-155-11	M32-157-11	Tail Voice
	M32-159-01	Caliper

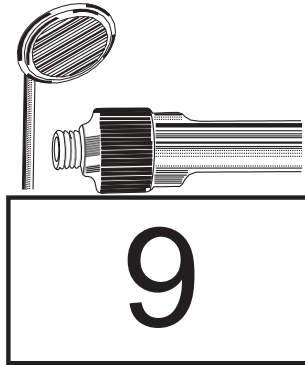

DENTAL MIRROR & SYRINGES



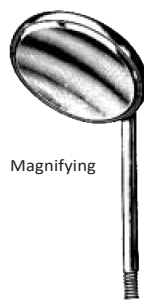
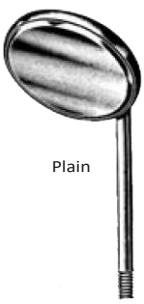
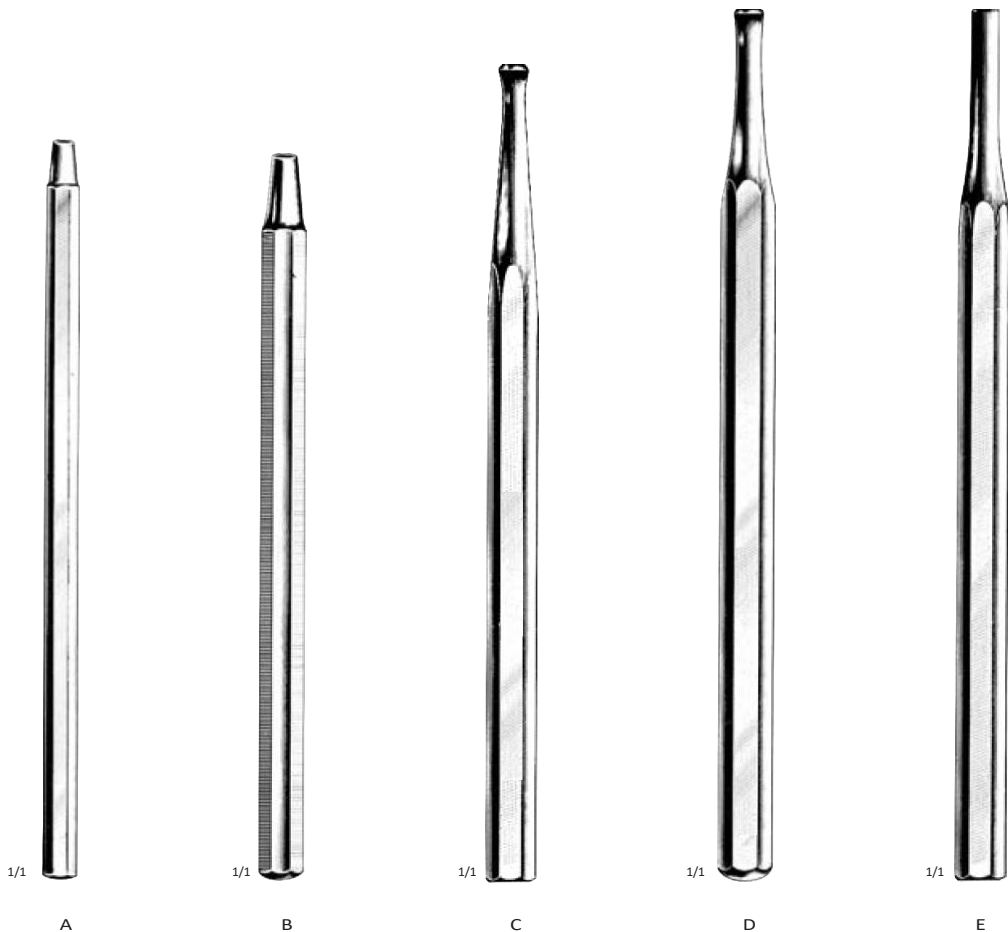

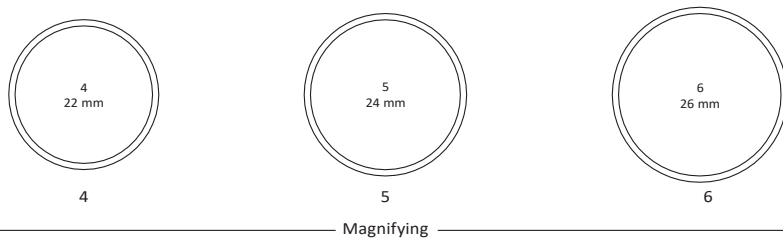
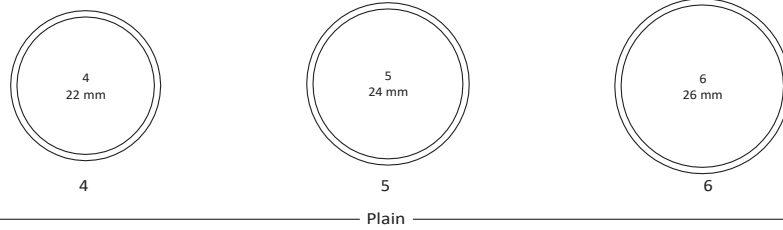

4 5 6
————— Plain —————

A	M33-001-04	M33-011-05	M33-021-06
B	M33-003-04	M33-013-05	M33-023-06
C	M33-005-04	M33-015-05	M33-025-06
D	M33-007-04	M33-017-05	M33-027-06
E	M33-009-04	M33-019-05	M33-029-06

4 5 6
————— Magnifying —————

A	M33-031-04	M33-041-05	M33-051-06
B	M33-033-04	M33-043-05	M33-053-06
C	M33-035-04	M33-045-05	M33-055-06
D	M33-037-04	M33-047-05	M33-057-06
E	M33-039-04	M33-049-05	M33-059-06

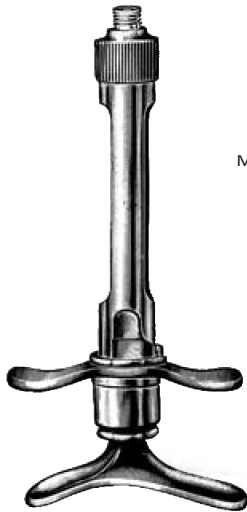

M33-141-00
Cartridge Syringe



M33-143-01



M33-143-02

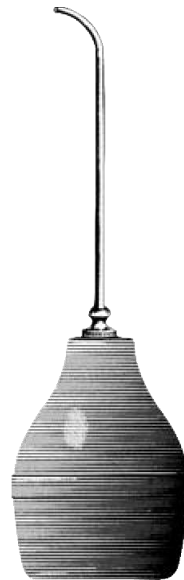

M33-145-00

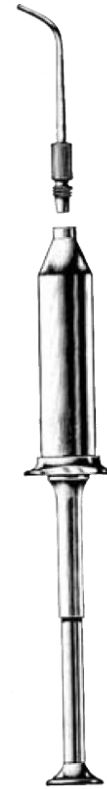

M33-161-00



M33-163-00



M33-155-03
Cannulas



M33-157-03
Cannulas



M33-159-03
Cannulas

M33-141-00		Cartridge Syringe
M33-145-00		Chip Blower Syringe with cannula and bulb
M33-155-03	M33-159-03	Cannula for above
M33-161-00	M33-163-00	Matel Syringe



M33-165-00



M33-167-00



M33-169-00



M33-171-00



M33-173-00



M33-175-00



M33-177-00

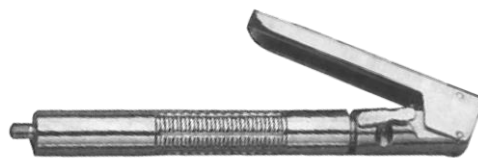

M33-179-00

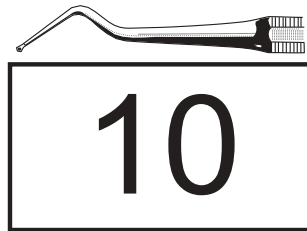

EXPLORERS



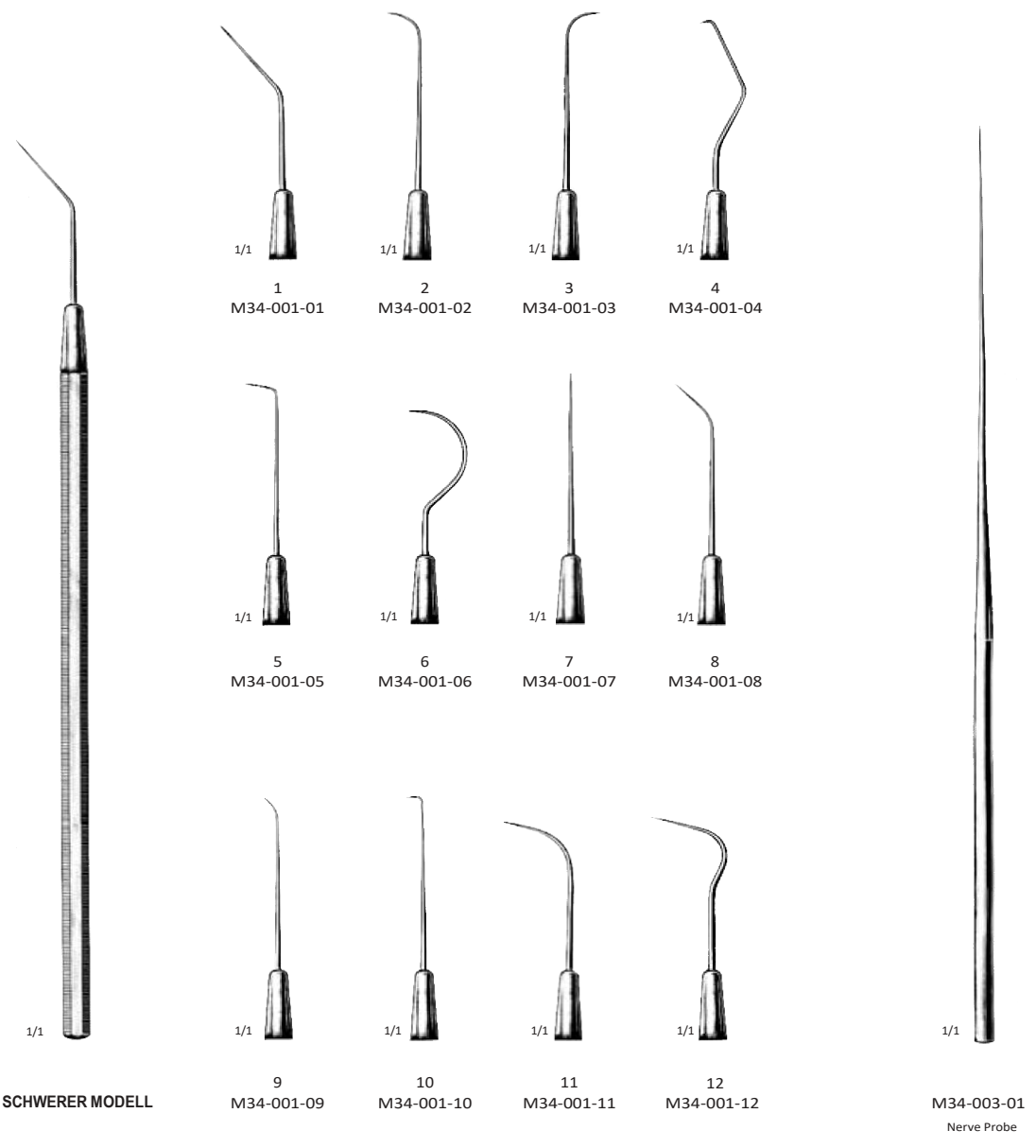

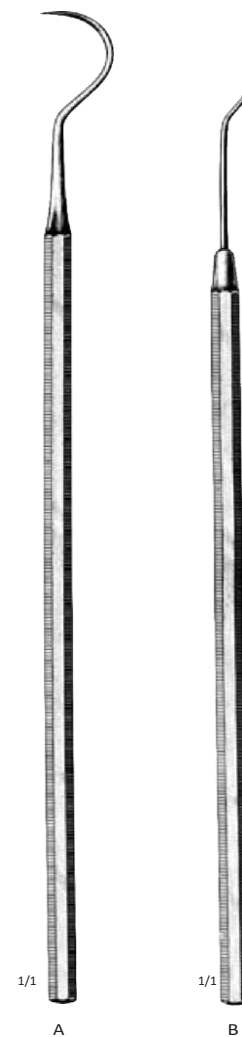
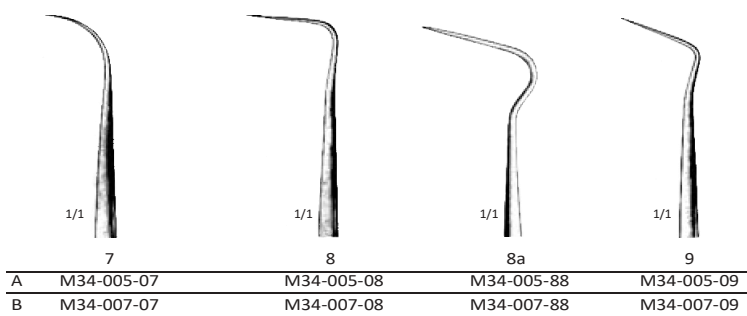
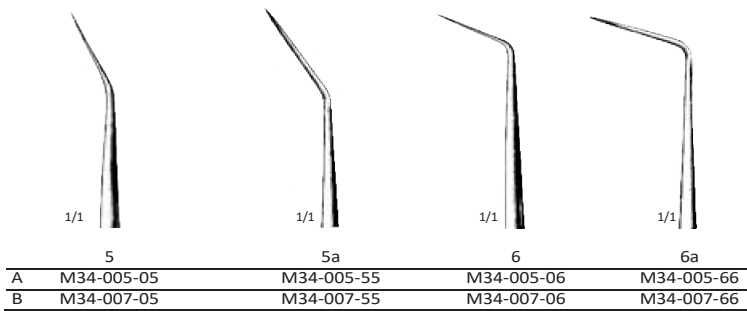
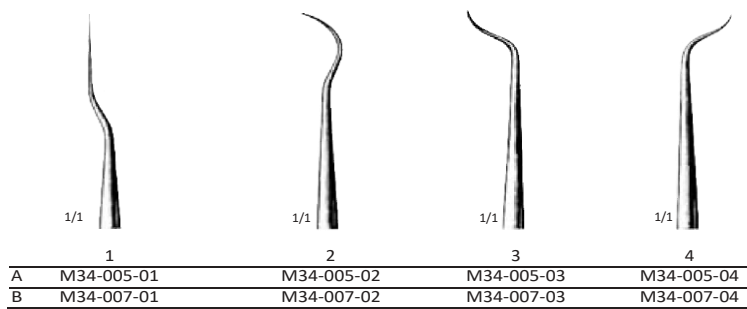

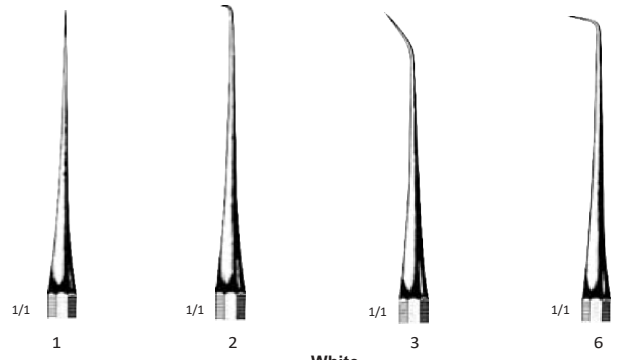

	White			
A	M34-009-01	M34-009-02	M34-009-03	M34-009-06
B	M34-011-01	M34-011-02	M34-011-03	M34-011-06
C	M34-013-01	M34-013-02	M34-013-03	M34-013-06

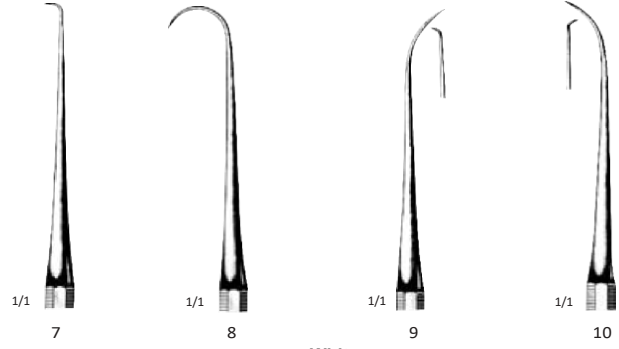

	White			
A	M34-009-07	M34-009-08	M34-009-09	M34-009-10
B	M34-011-07	M34-011-08	M34-011-09	M34-011-10
C	M34-013-07	M34-013-08	M34-013-09	M34-013-10

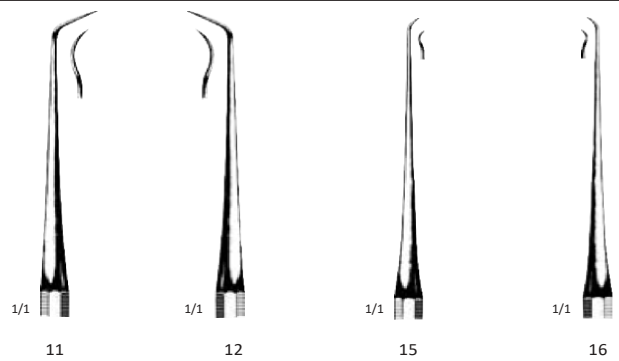

	White			
A	M34-009-11	M34-009-12	M34-009-15	M34-009-16
B	M34-011-11	M34-011-12	M34-011-15	M34-011-16
C	M34-013-11	M34-013-12	M34-013-15	M34-013-16

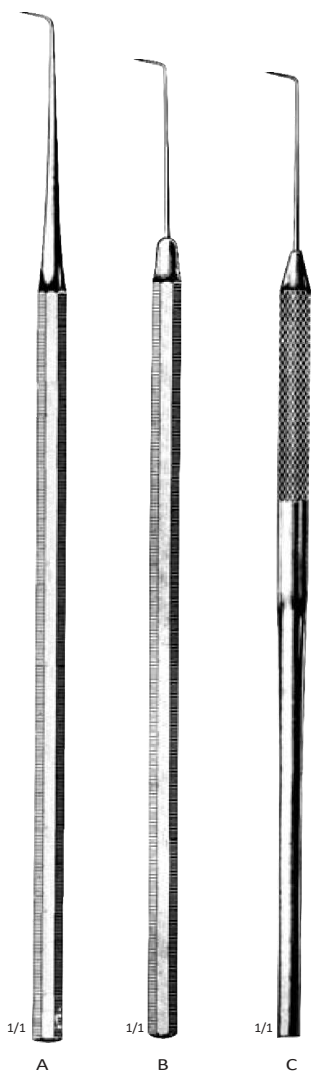

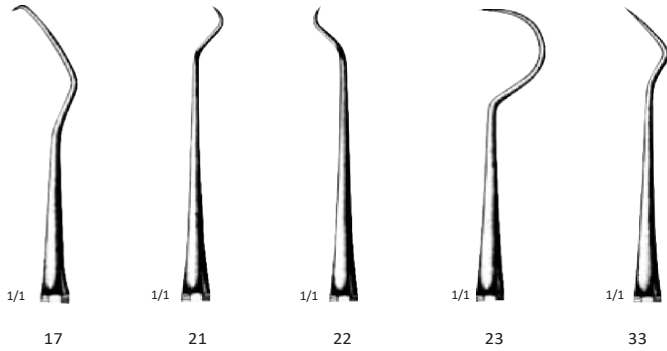

	White				
A	M34-015-17	M34-015-21	M34-015-22	M34-015-23	M34-015-33
B	M34-016-17	M34-016-21	M34-016-22	M34-016-23	M34-016-33
C	M34-017-17	M34-017-21	M34-017-22	M34-017-23	M34-017-33

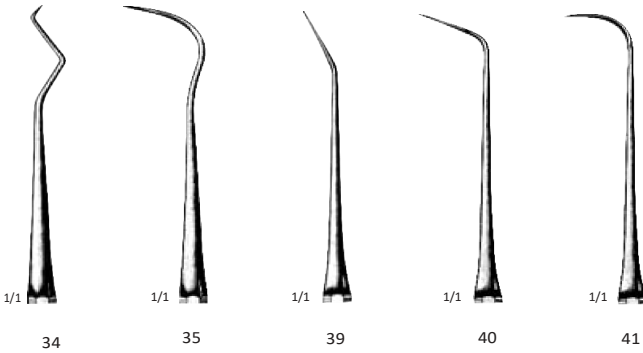

	White				
A	M34-015-34	M34-015-35	M34-015-39	M34-015-40	M34-015-41
B	M34-016-34	M34-016-35	M34-016-39	M34-016-40	M34-016-41
C	M34-017-34	M34-017-35	M34-017-39	M34-017-40	M34-017-41

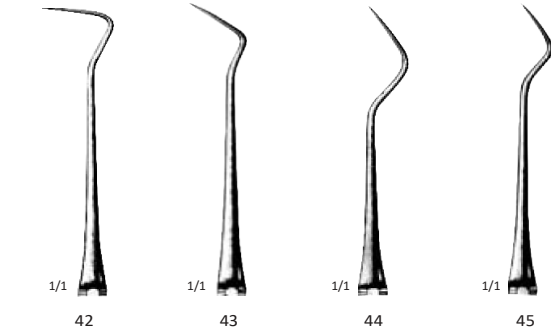

	White			
A	M34-015-42	M34-015-43	M34-015-44	M34-015-45
B	M34-016-42	M34-016-43	M34-016-44	M34-016-45
C	M34-017-42	M34-017-43	M34-017-44	M34-017-45

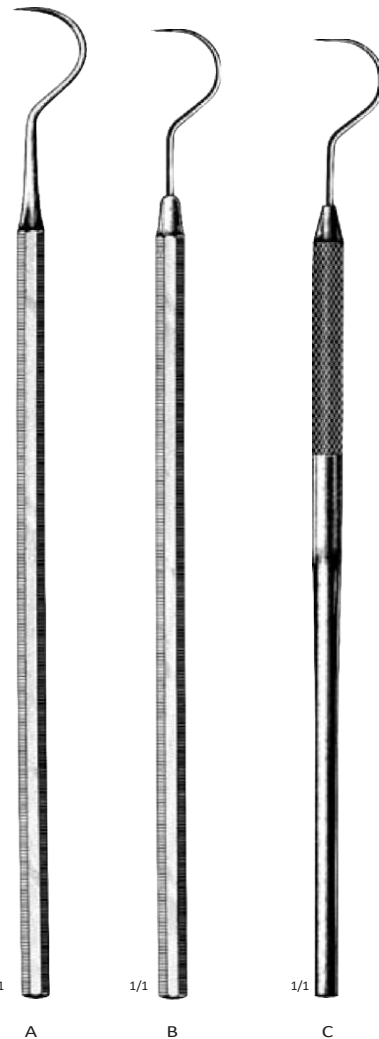

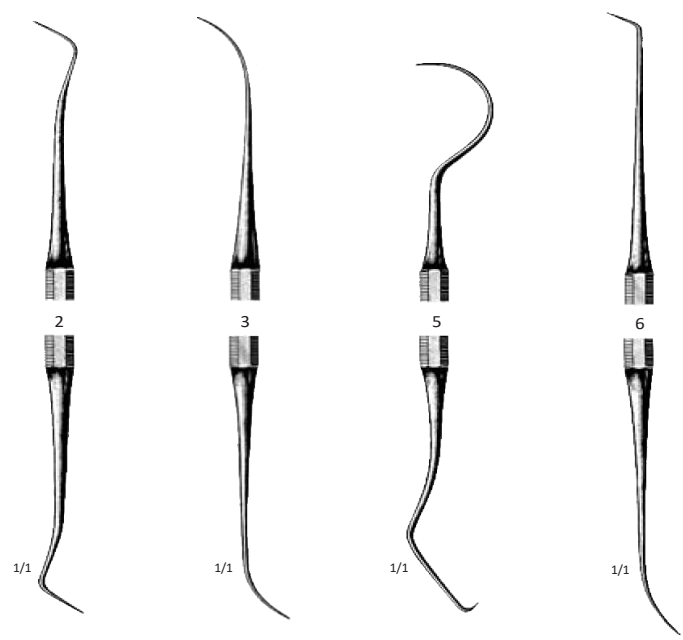

A	M34-018-02	M34-018-03	M34-018-05	M34-018-06
B	M34-019-02	M34-019-03	M34-019-05	M34-019-06
C	M34-020-02	M34-020-03	M34-020-05	M34-020-06

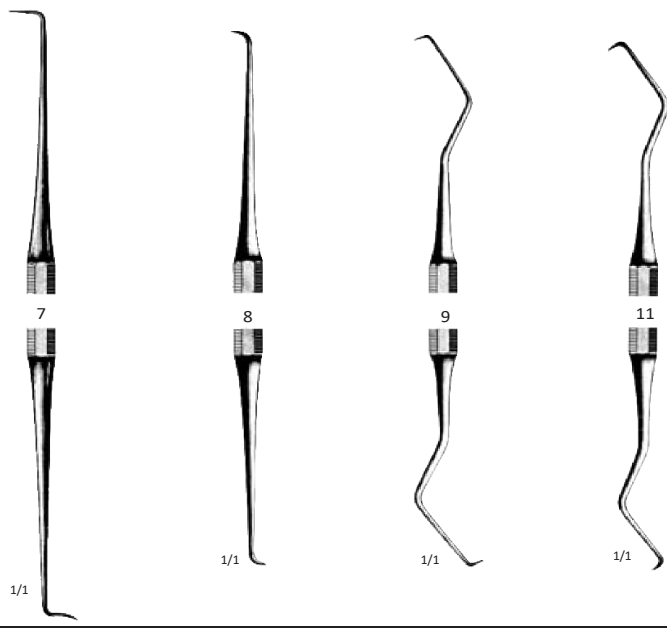

A	M34-018-07	M34-018-08	M34-018-09	M34-018-11
B	M34-019-07	M34-019-08	M34-019-09	M34-019-11
C	M34-020-07	M34-020-08	M34-020-09	M34-020-11

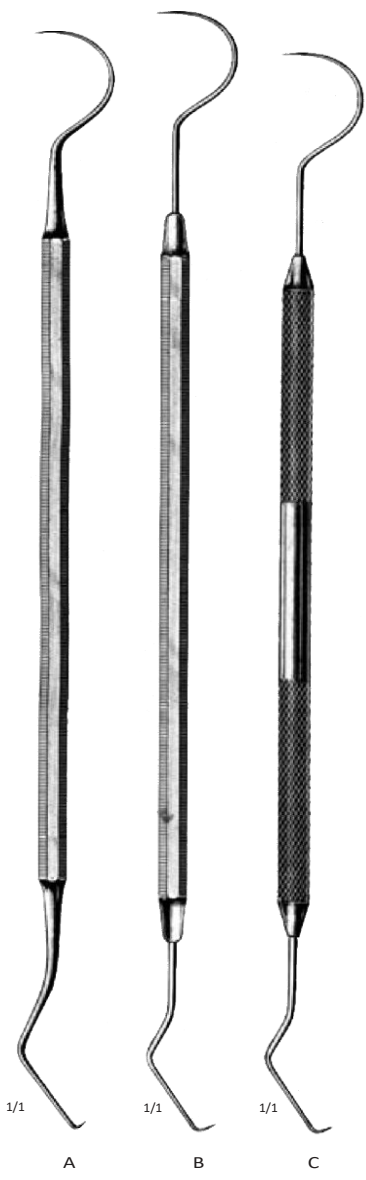

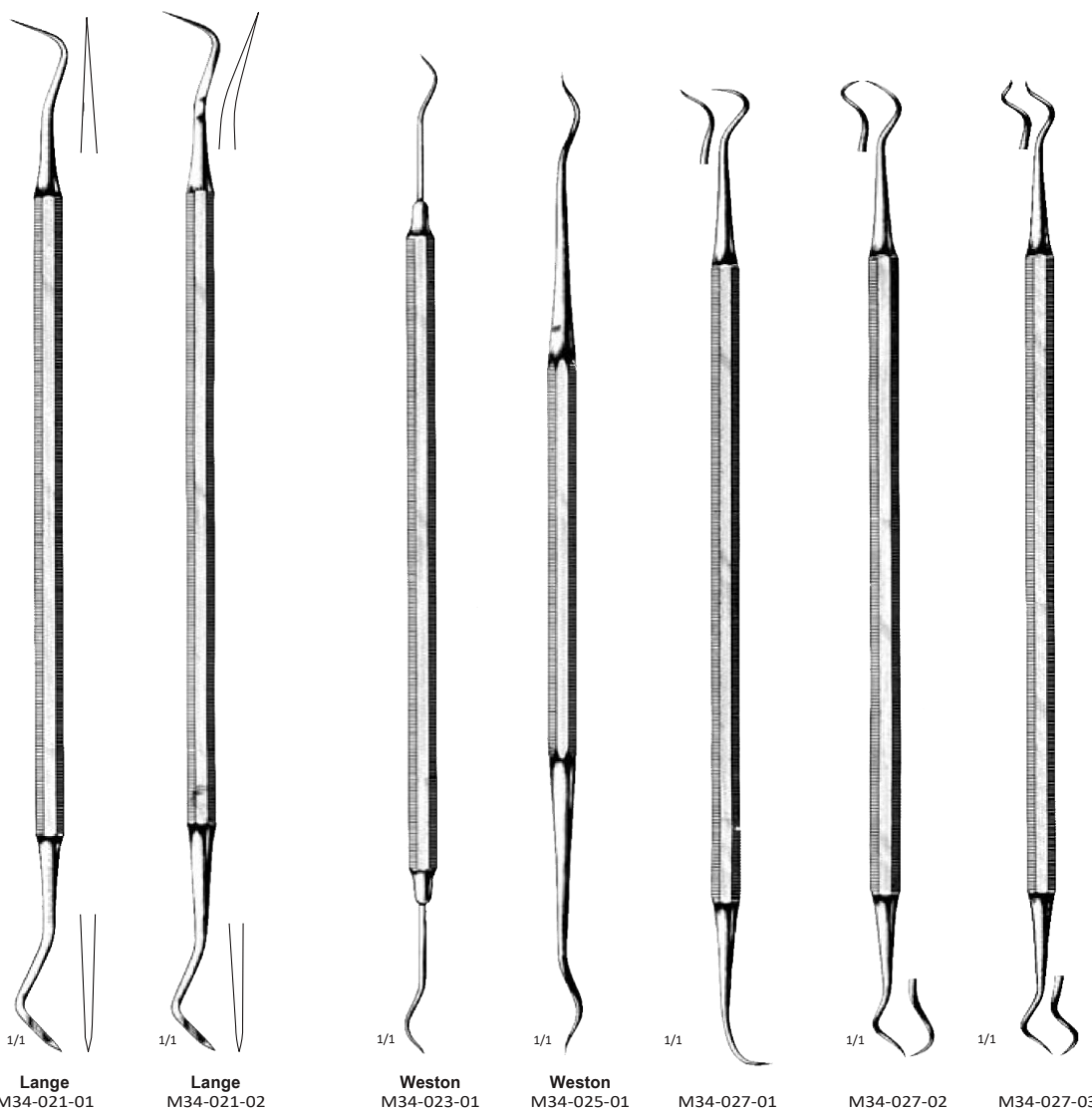

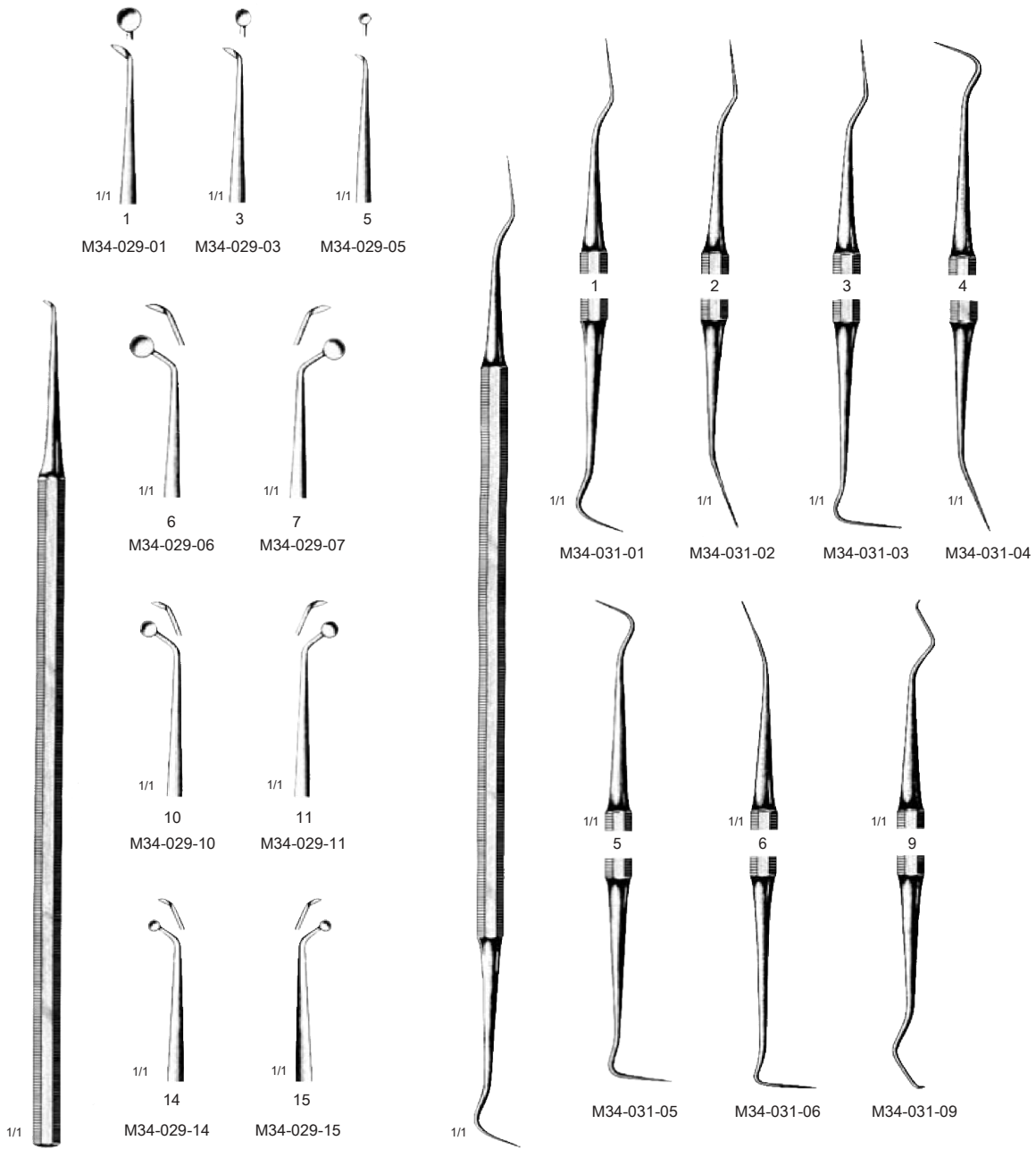

Witzel
Dentine Spoon

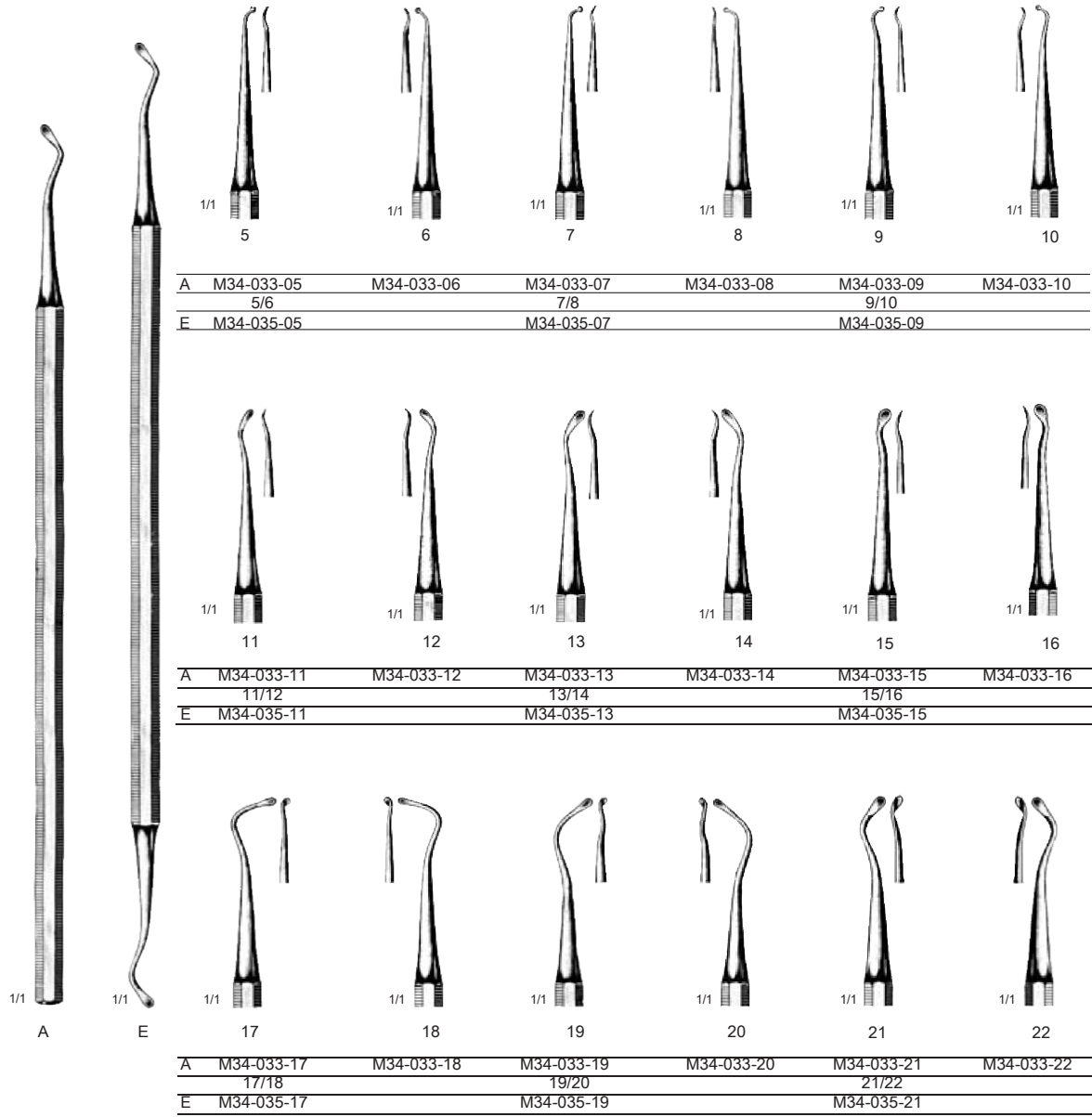

Darby-Perry

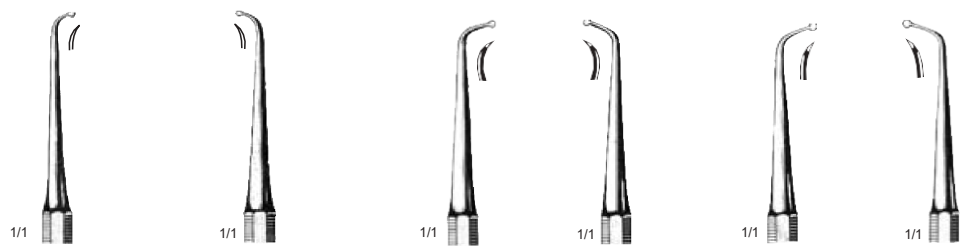



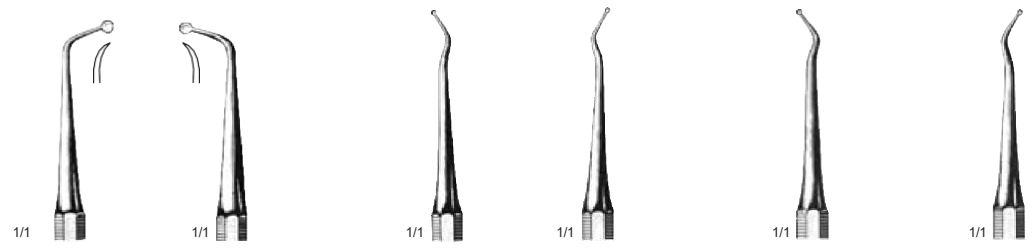

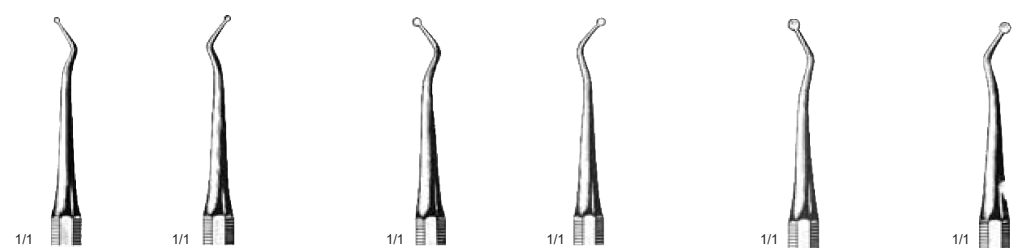

	3	4	7	8	9	10
A	M34-037-03	M34-037-04	M34-037-07	M34-037-08	M34-037-09	M34-037-10
	3/4		7/8		9/8	
E	M34-039-03		M34-039-07		M34-039-09	



















	11	12	13	14	15	16
A	M34-037-11	M34-037-12	M34-037-13	M34-037-14	M34-037-15	M34-037-16
	11/12		13/14		15/16	
E	M34-039-11		M34-039-13		M34-039-15	



	17	18	19	20	21	22
A	M34-037-17	M34-037-18	M34-037-19	M34-037-20	M34-037-21	M34-037-22
	17/18		19/20		21/22	
E	M34-039-17		M34-039-19		M34-039-21	

						
	1/1	1/1	1/1	1/1	1/1	1/1
	23	24	25	26	27	28
A	M34-037-23	M34-037-24	M34-037-25	M34-037-26	M34-037-21	M34-037-28
	23/24		25/26		27/28	
E	M34-039-23		M34-039-25		M34-039-27	

								
	1/1	1/1	1/1	1/1	1/1	1/1	1/1	1/1
	29	30	31	32	33	34	35	36
A	M34-037-29	M34-037-30	M34-037-31	M34-037-32	M34-037-33	M34-037-34	M34-037-35	M34-037-36
	29/30		31/32		33/34		35/36	
E	M34-039-29		M34-039-31		M34-039-33		M34-039-35	

								
	1/1	1/1	1/1	1/1	1/1	1/1	1/1	1/1
	4 Gillet	5 Gillet	6 Gillet	7 Gillet	12 Gillet	13 Gillet	14 Gillet	15 Gillet
A	M34-041-04	M34-041-05	M34-041-06	M34-041-07	M34-041-12	M34-041-13	M34-041-14	M34-041-15
	4/5		6/7		12/13		14/15	
E	M34-043-04		M34-043-06		M34-043-12		M34-043-14	

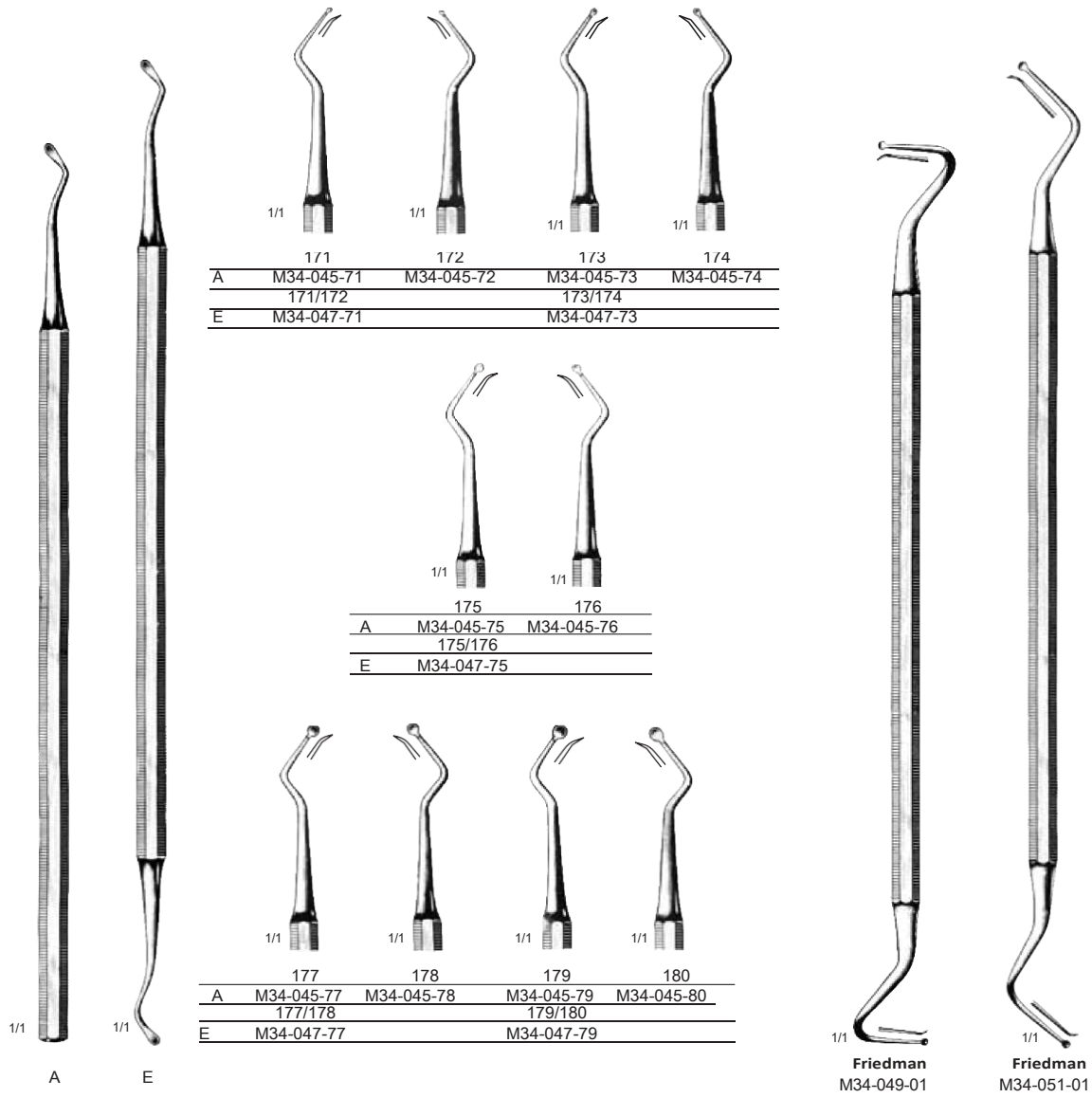

	171	172	173	174
A	M34-045-71	M34-045-72	M34-045-73	M34-045-74
	171/172		173/174	
E	M34-047-71		M34-047-73	

	175	176
A	M34-045-75	M34-045-76
	175/176	
E	M34-047-75	

	177	178	179	180
A	M34-045-77	M34-045-78	M34-045-79	M34-045-80
	177/178		179/180	
E	M34-047-77		M34-047-79	

Friedman
M34-049-01

Friedman
M34-051-01

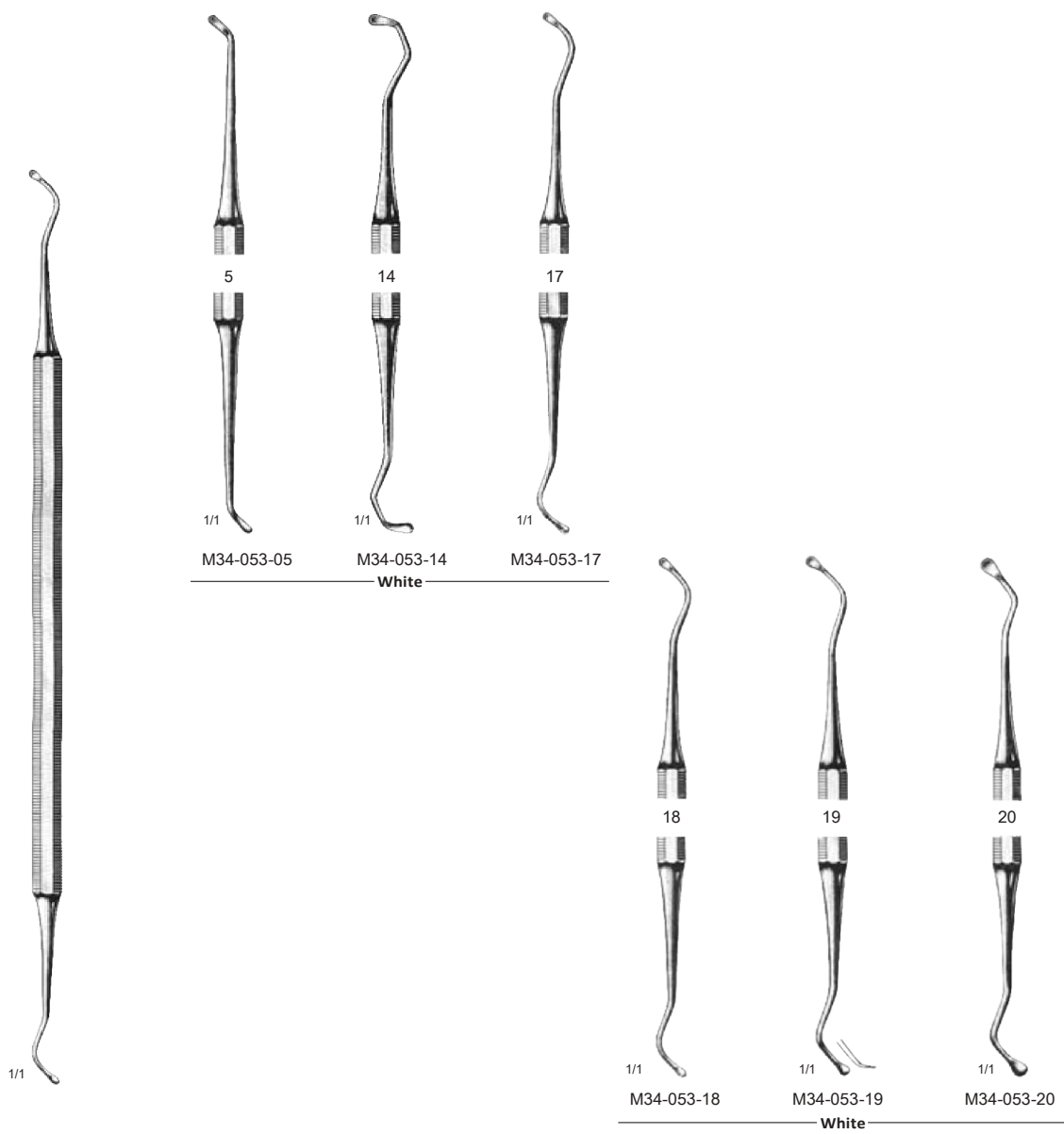

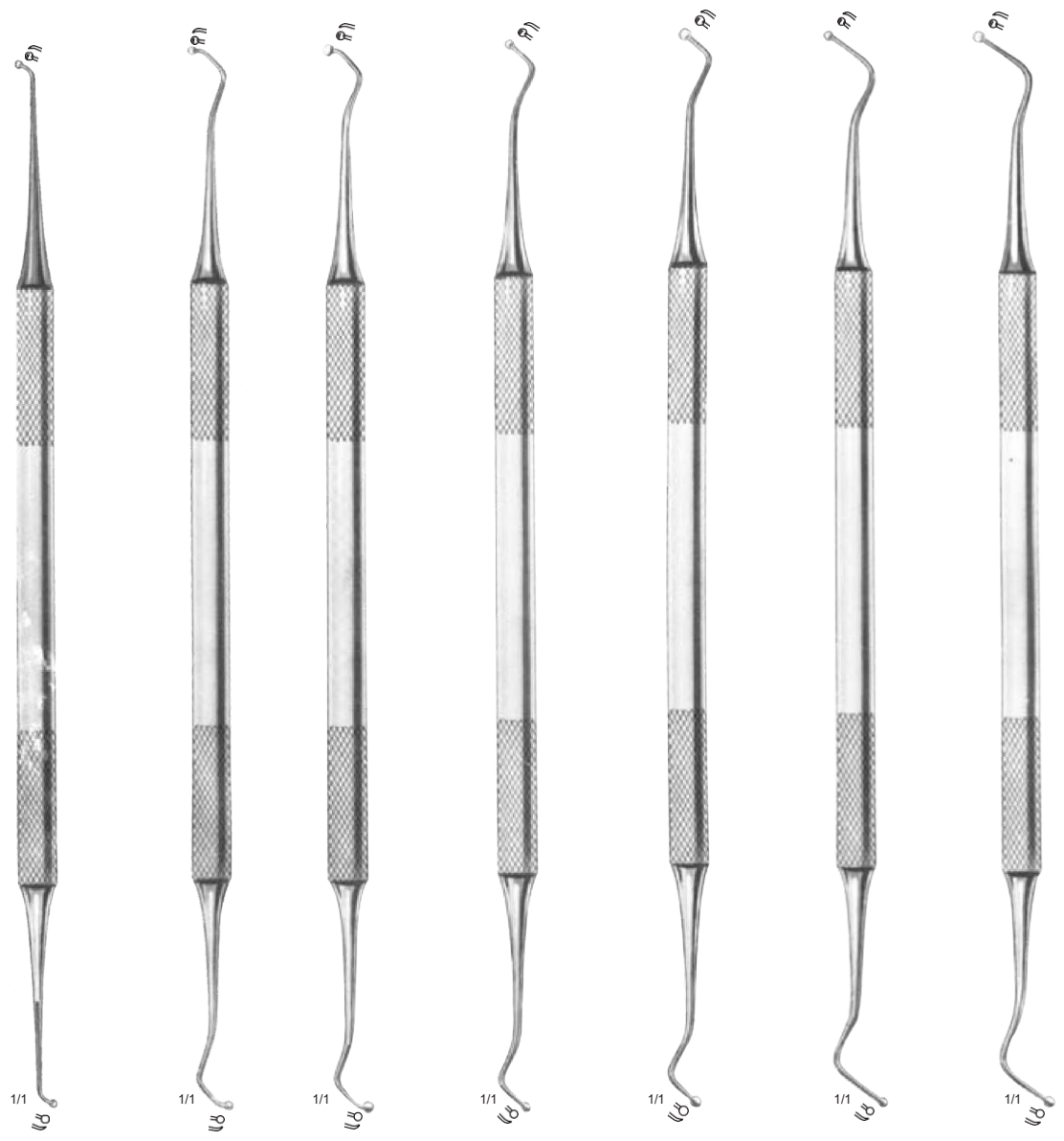

M34-055-05

M34-055-13





















M34-055-14

M34-055-17

M34-055-18







M34-055-31







M34-055-33







1/1							
	3	9	14	17	20	28	32
	M34-057-03	M34-057-09	M34-057-14	M34-057-17	M34-057-20	M34-057-28	M34-057-32
	A	10	10	12	6	12	8
	B	4	4	5	2	5	3
	C	6	12	18	18	23	6
							
	38	41	51	52	53	54	57
	M34-057-38	M34-057-41	M34-057-51	M34-057-52	M34-057-53	M34-057-54	M34-057-57
A	12	6	15	15	10	10	
B	5	2	8	8	6	6	
C	18	18	12	12	12	12	
		L	R	L	R	L	
1/1							
	58	61	62	63	64	65	66
	M34-057-58	M34-057-61	M34-057-62	M34-057-63	M34-057-64	M34-057-65	M34-057-6610
	A	15	20	15	15	10	6
	B	8	9	9	8	8	6
	C	R	L	R	L	R	L

A) Width of Blade in 1/10 mm
B) Length of the blade in mm
C) Angle of the blade to its handle



						
69 M34-059-69	70 M34-059-70	73 M34-059-73	74 M34-059-74	75 M34-059-75	76 M34-059-76	77 M34-059-77
A 15	15	20	20	20	20	15
B 8	8	9	9	9	9	8
C 23	23	12	12	12	12	12
L	R	L	R	L	R	L

					
78 M34-059-78	81 M34-059-81	82 M34-059-82	83 M34-059-83	84 M34-059-84	85 M34-059-85
A 15	20	15	10	20	15
B 8	9	8	6	20	15
C 12	6	6	6		
R					

						
86 M34-059-86	87 M34-059-87	90 M34-059-90	93 M34-059-93	95 M34-059-95	98 M34-059-98	99 M34-059-99
A 10	5	15	15	12	8	12
B 3	3	1 1/2	8	6	8	8
C 28	12	12	12	23	12	12

A) Width of Blade in 1/10 mm
 B) Length of the blade in mm
 C) Angle of the blade to its handle



49	51	53	57	61	63
M34-061-49	M34-061-51	M34-061-53	M34-061-57	M34-061-61	M34-061-63
20	15	10	15	20	15
9	8	6	8	9	8
12	12	12	6	12	12
L	L	L	L	L	L

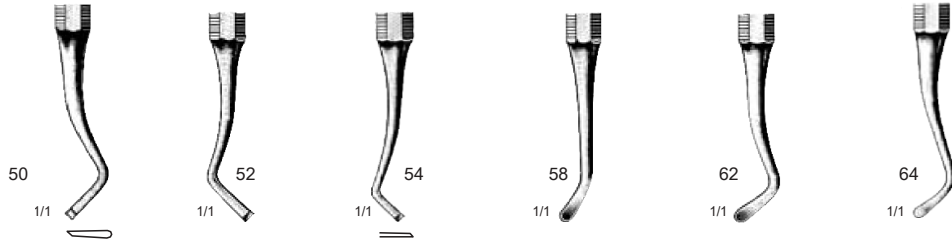
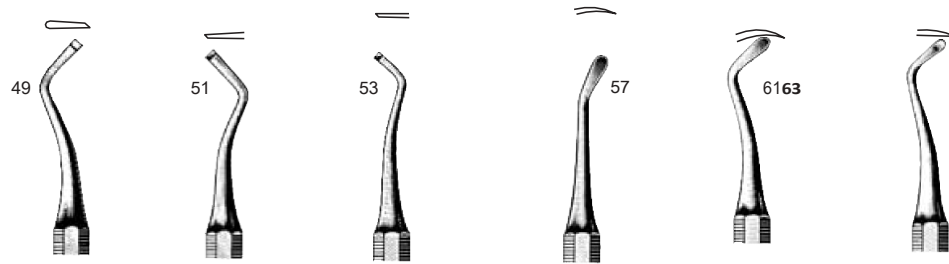

50	52	54	58	62	64
M34-061-50	M34-061-52	M34-061-54	M34-061-58	M34-061-62	M34-061-64
20	15	10	15	20	15
9	8	6	8	9	8
12	12	12	6	12	12
L	L	L	L	L	L

A) Width of Blade in 1/10 mm
B) Length of the blade in mm
C) Angle of the blade to its handle

1/1

Cutting Instruments, double ended



65	69	73	75	77	79
M34-063-65	M34-063-69	M34-063-73	M34-063-75	M34-063-77	M34-063-79
10	15	20	20	15	15
6	8	9	9	8	8
12	23	12	12	12	12
R	R	R	R	R	R

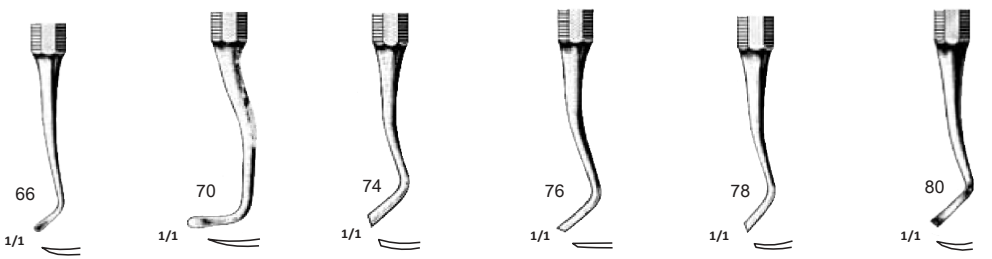
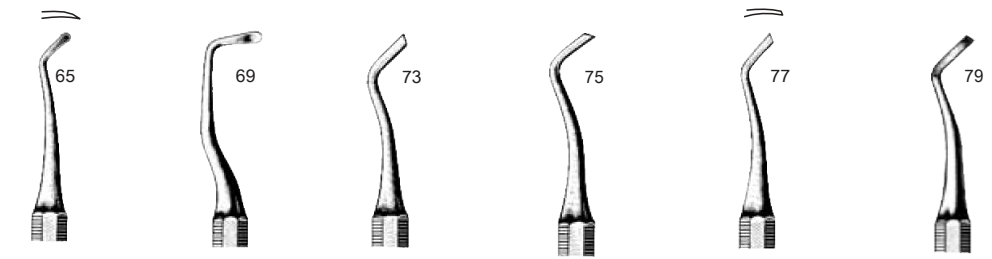

66	70	74	76	78	80
M34-063-66	M34-063-70	M34-063-74	M34-063-76	M34-063-78	M34-063-80
10	15	20	20	15	15
6	8	9	9	8	8
12	23	12	12	12	12
L	L	L	L	L	L

A) Width of Blade in 1/10 mm
 B) Length of the blade in mm
 C) Angle of the blade to its handle

1/1

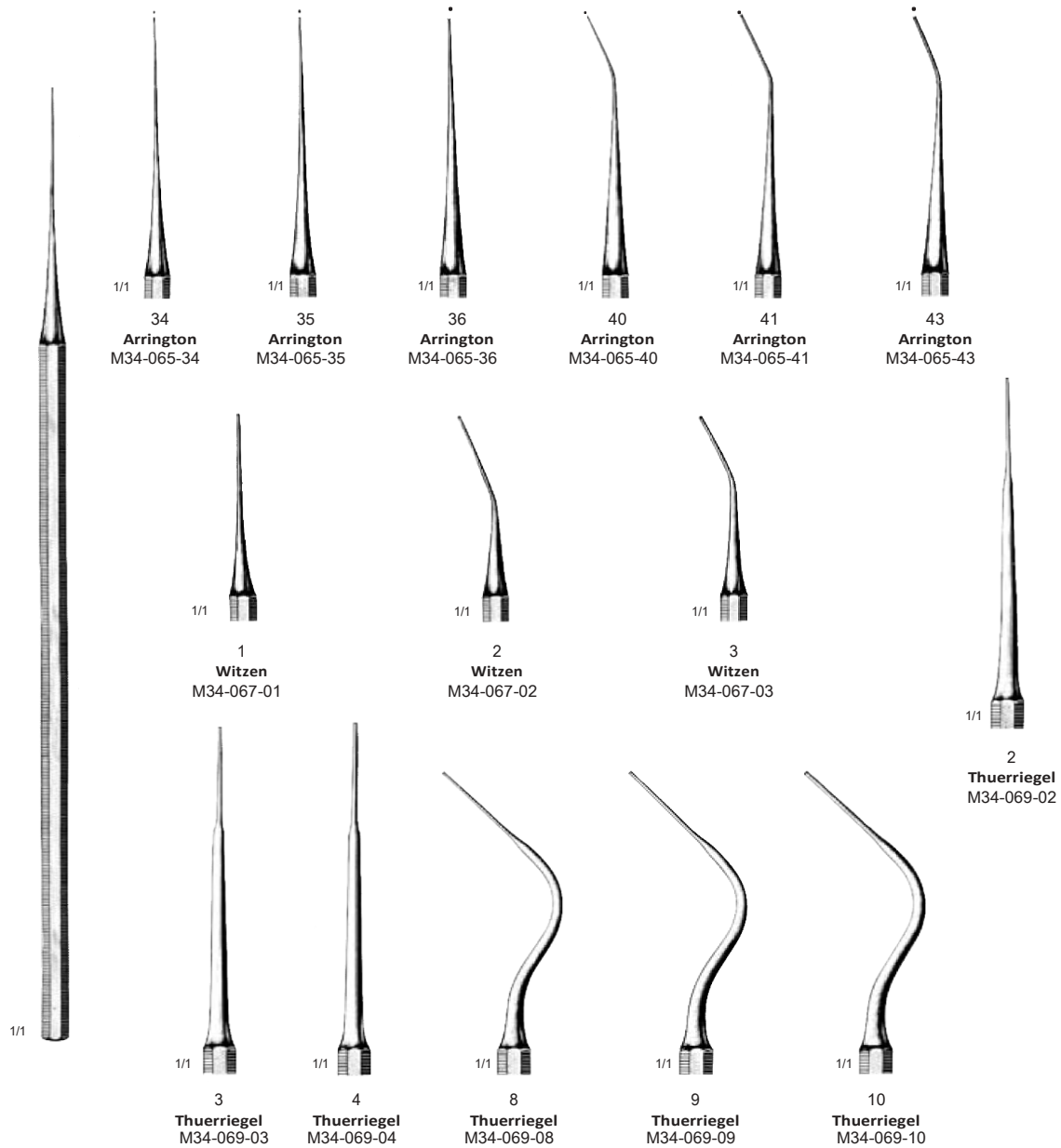

M34-065-34	M34-065-43	Nerve Extractors, Spring tempered
M34-067-01	M34-067-03	Nerve and Root-Canal Pluggers
M34-069-02	M34-069-10	Nerve and Root-Canal Pluggers

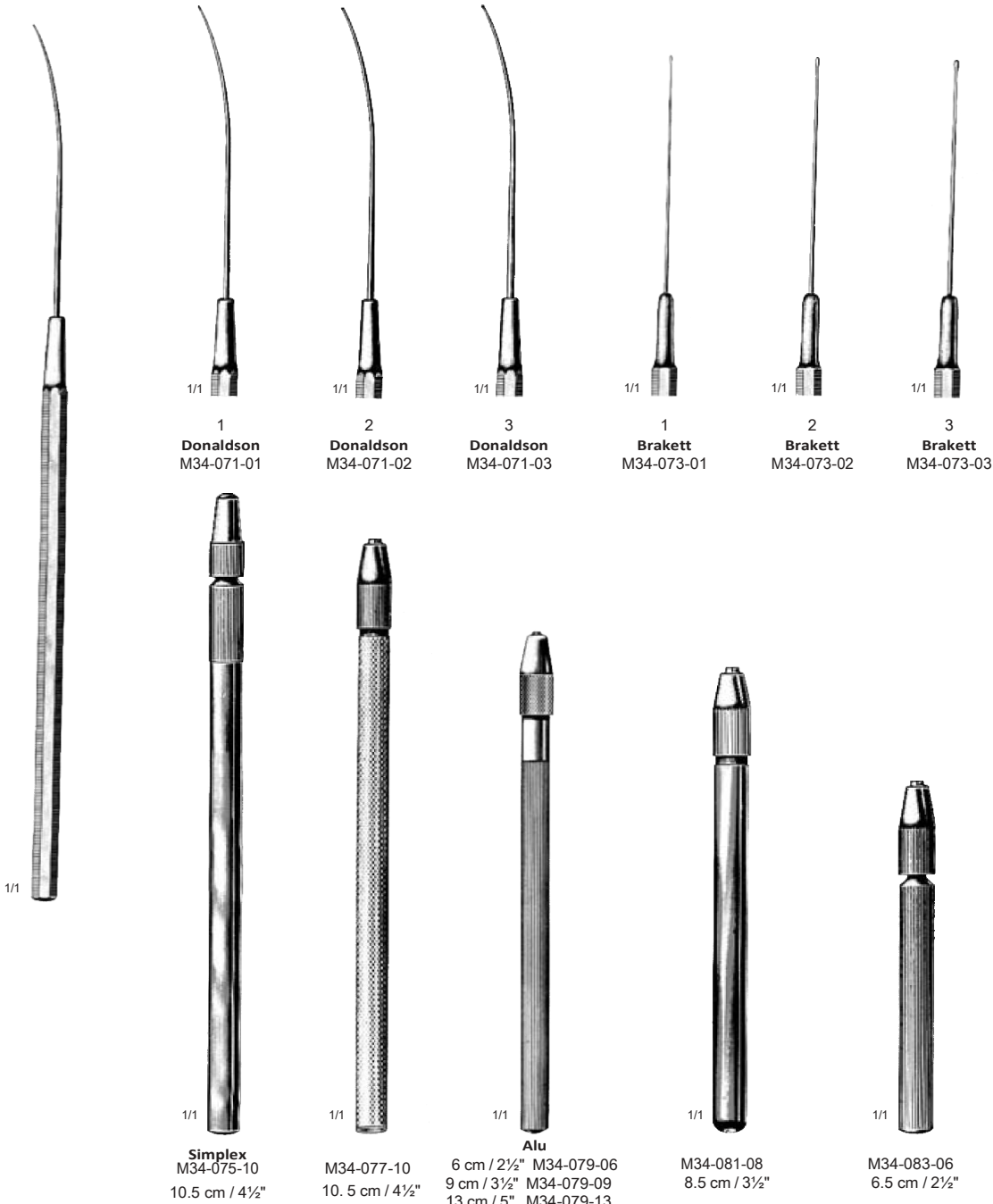

1
Donaldson
M34-071-01

2
Donaldson
M34-071-02

3
Donaldson
M34-071-03

1
Brakett
M34-073-01

2
Brakett
M34-073-02

3
Brakett
M34-073-03

Simplex
M34-075-10
10.5 cm / 4 1/2"

M34-077-10
10.5 cm / 4 1/2"

Alu
6 cm / 2 1/2" M34-079-06
9 cm / 3 1/2" M34-079-09
13 cm / 5" M34-079-13

M34-081-08
8.5 cm / 3 1/2"

M34-083-06
6.5 cm / 2 1/2"

M34-071-01	M34-071-03	Nerve Canal Pluggers
M34-073-01	M34-073-03	Abscess and Fistula Probes

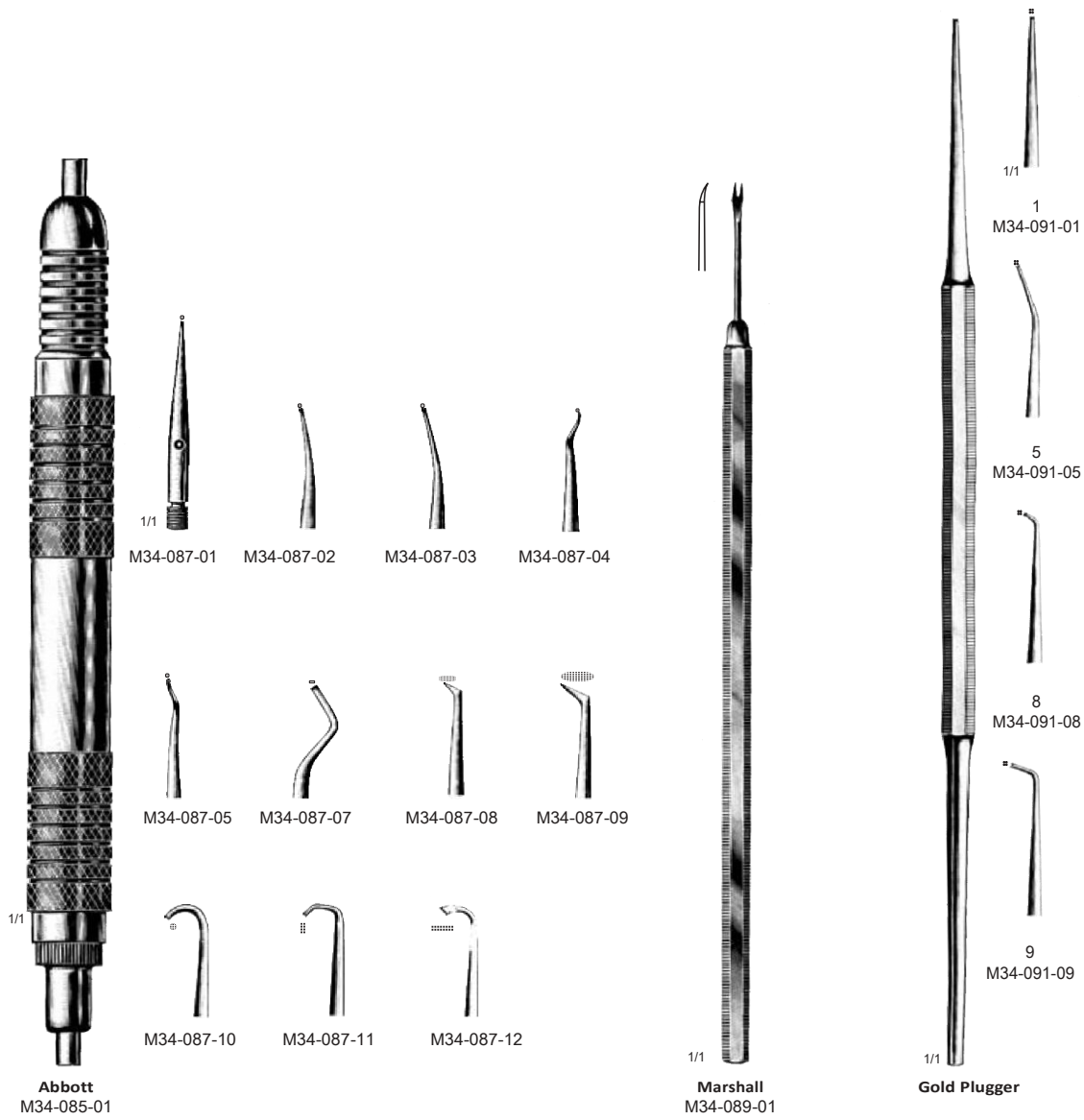

M34-085-01	Automatic mallet
M34-089-01	Pellet Placer
M34-091-01	M34-091-09
	Gold pluggers

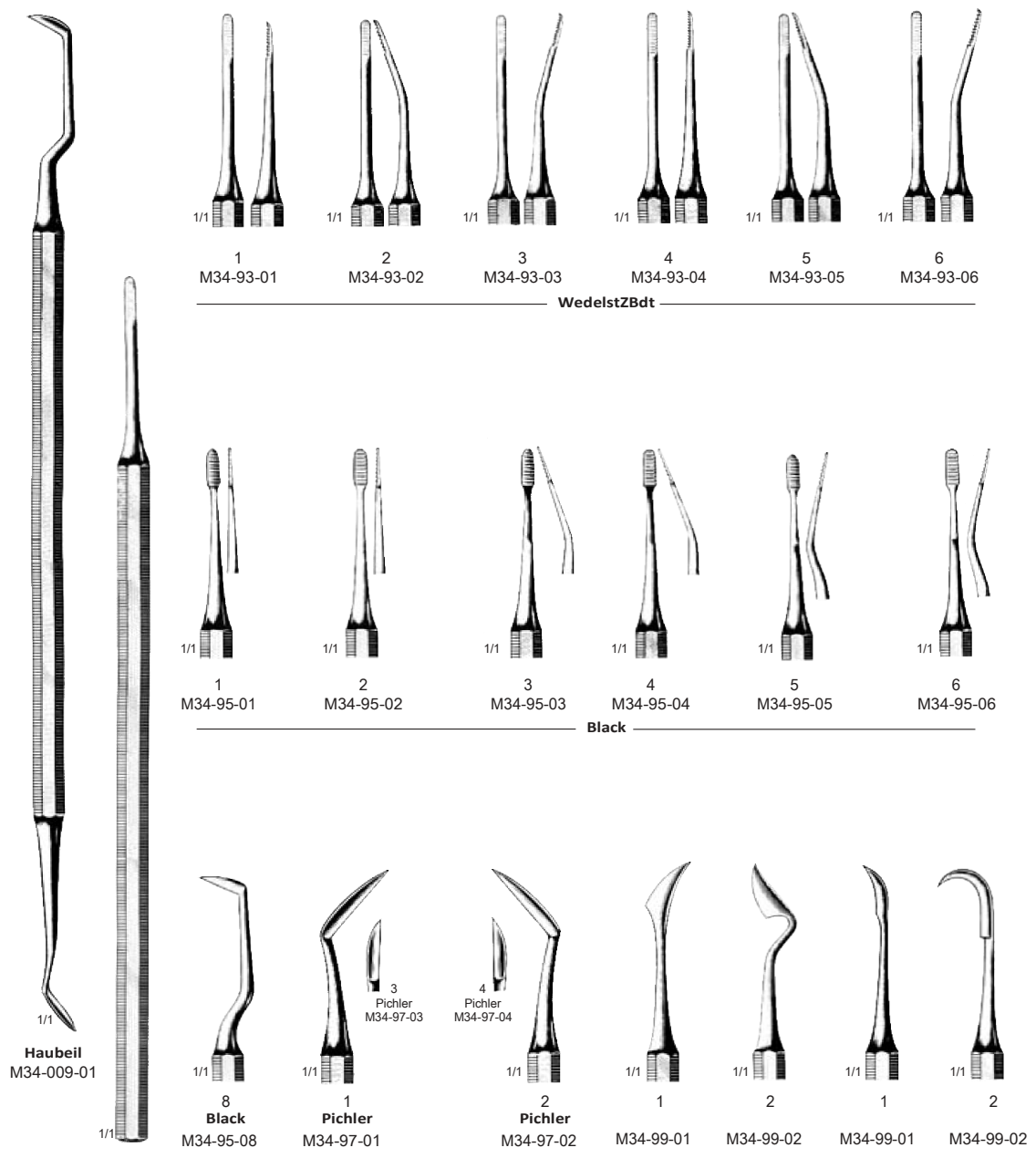

M34-93-01	M34-95-06	Finishing Files
M34-95-08	M34-99-02	Finishing Knives



Tompkins

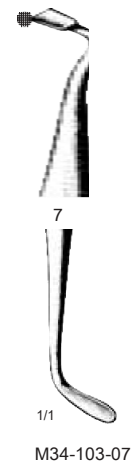
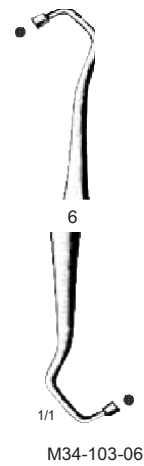
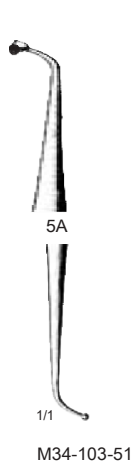
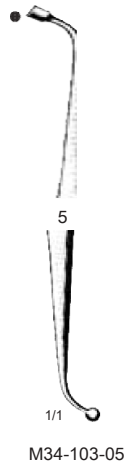
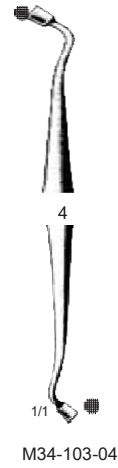
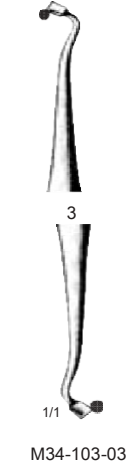
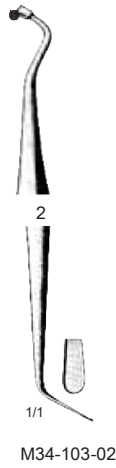
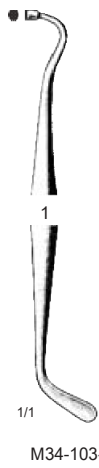

M34-101-01	M34-101-21	Finishing Files
M34-103-01	M34-103-07	Amalgam Pluggers

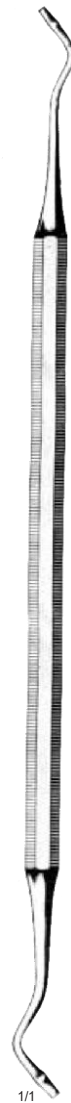

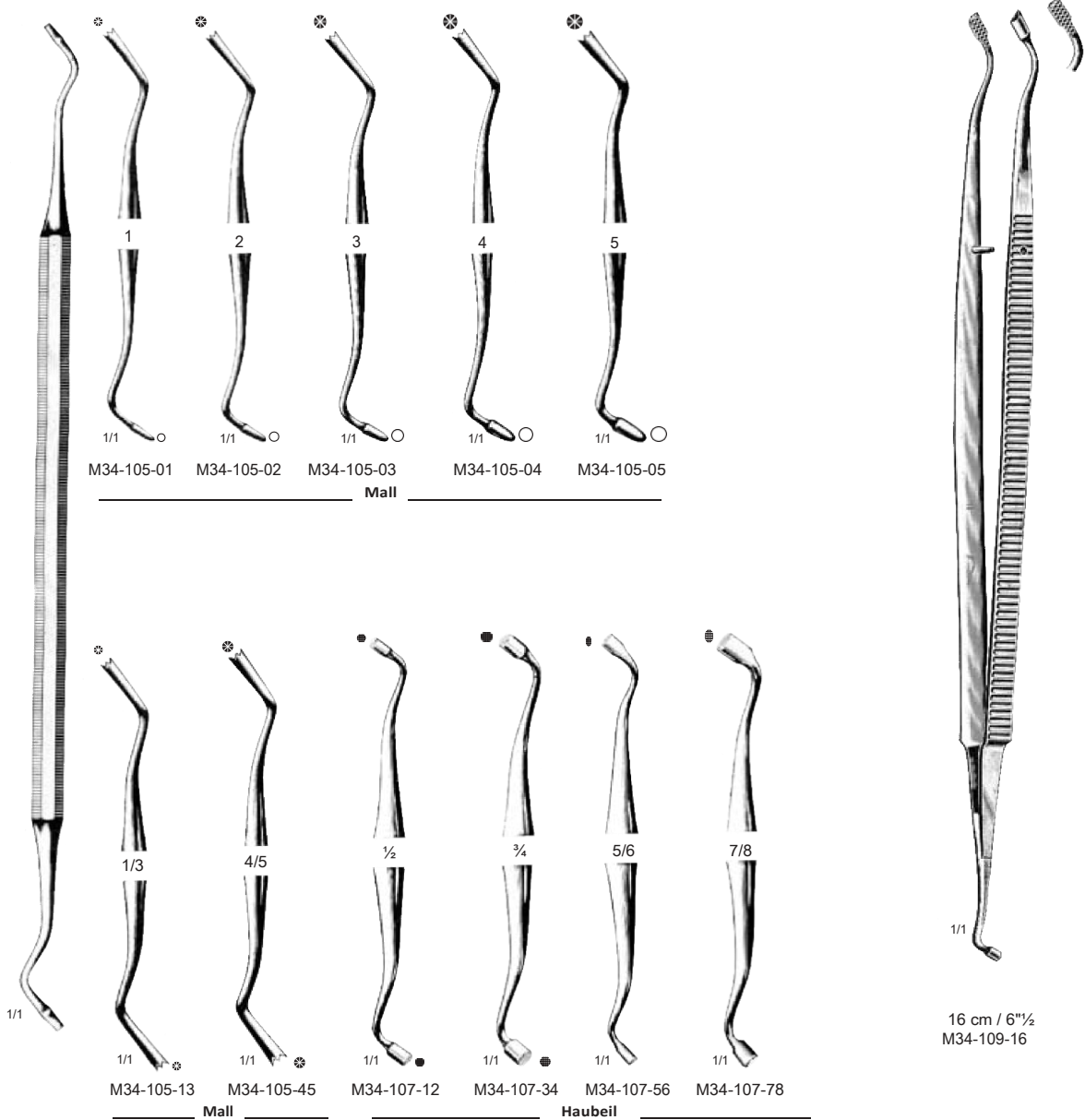

M34-107-78	M34-105-01	Amalgam Pluggers
	M34-109-02	Amalgam Spetula
	M34-111-16	Amalgam Plugging Pliers

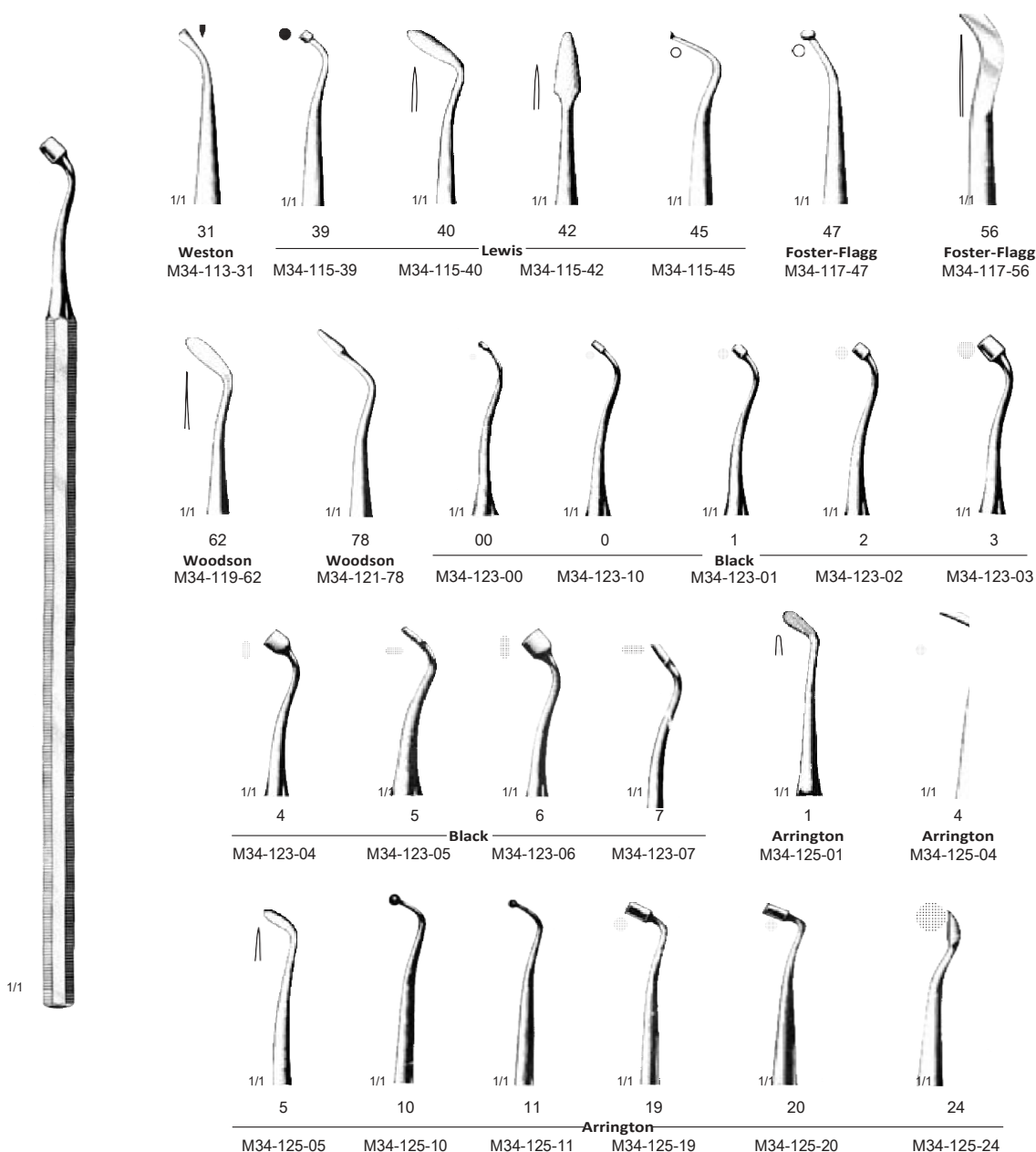

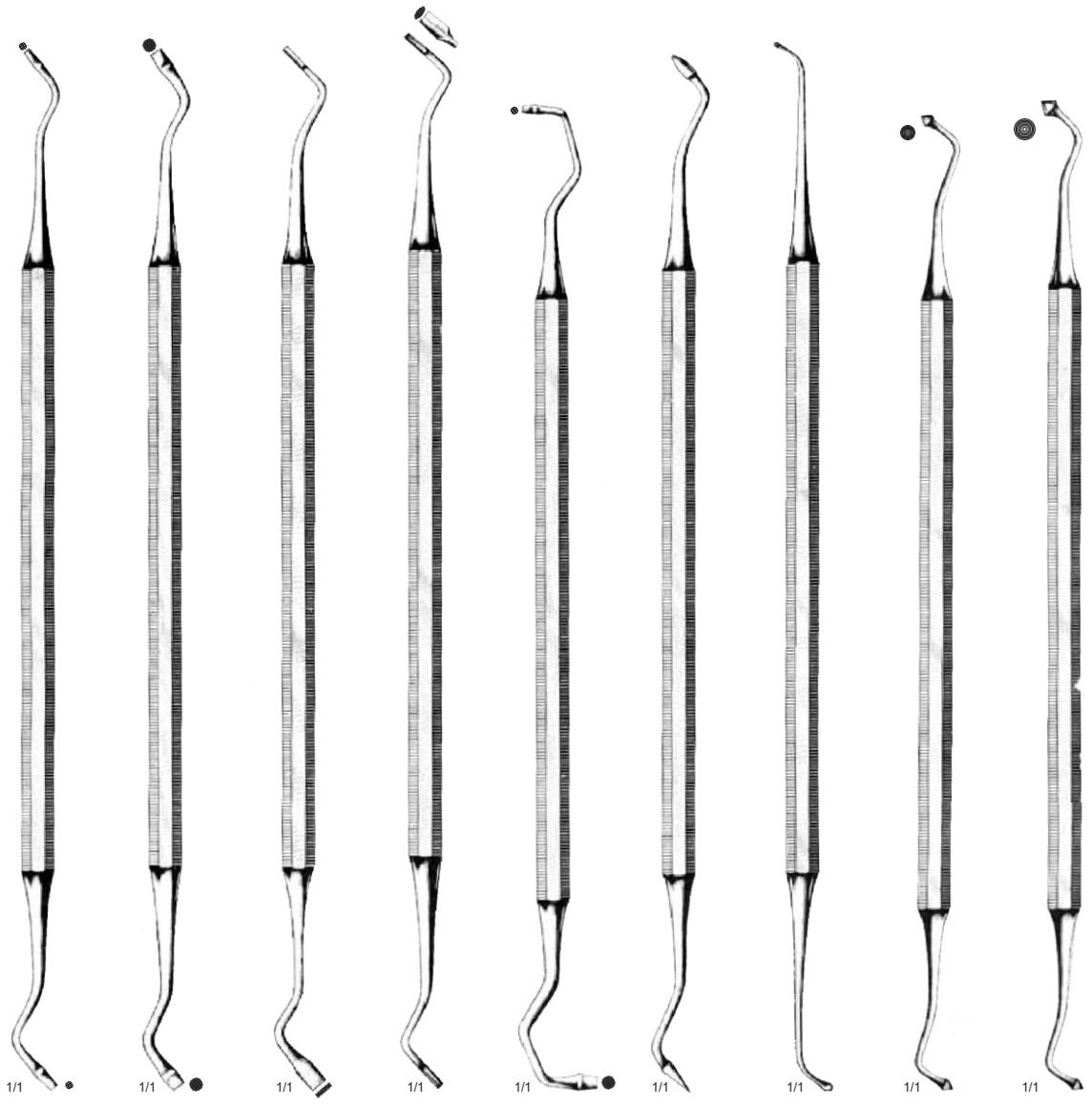

M34-126-01	M34-126-02	M34-126-03	Hollenback M34-126-04	M34-126-05	M34-126-06	M34-126-07	Mod. USA M34-127-01	Mod. USA M34-127-02
------------	------------	------------	---------------------------------	------------	------------	------------	-------------------------------	-------------------------------

M34-126-01 M34-127-02 Amalgam Condensers, Double-ended



1/1
Pallas
M34-128-01



1/1
M34-129-01



1/1
Elliot
M34-130-01

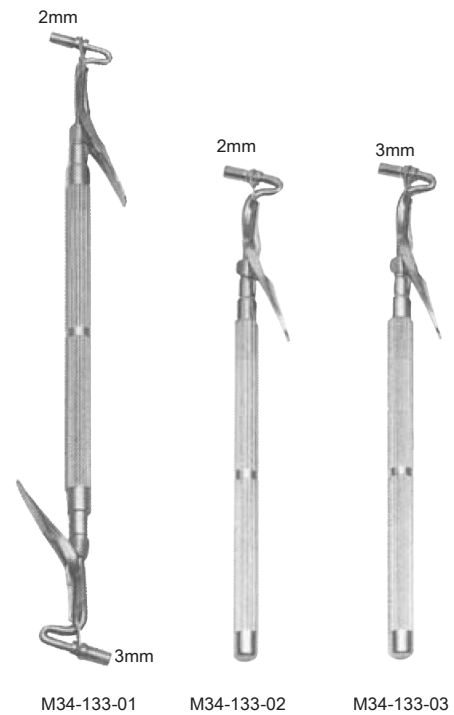
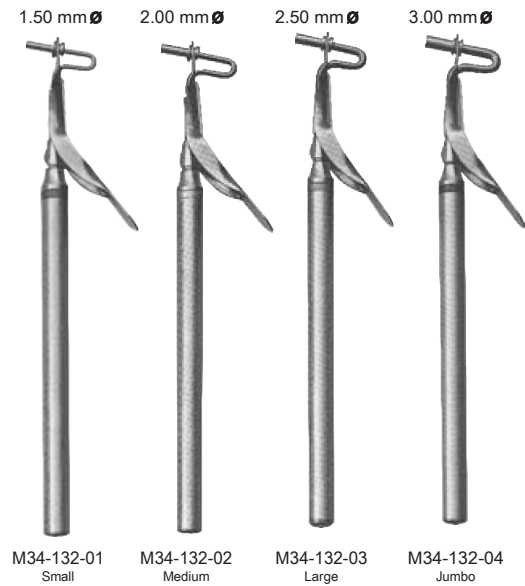
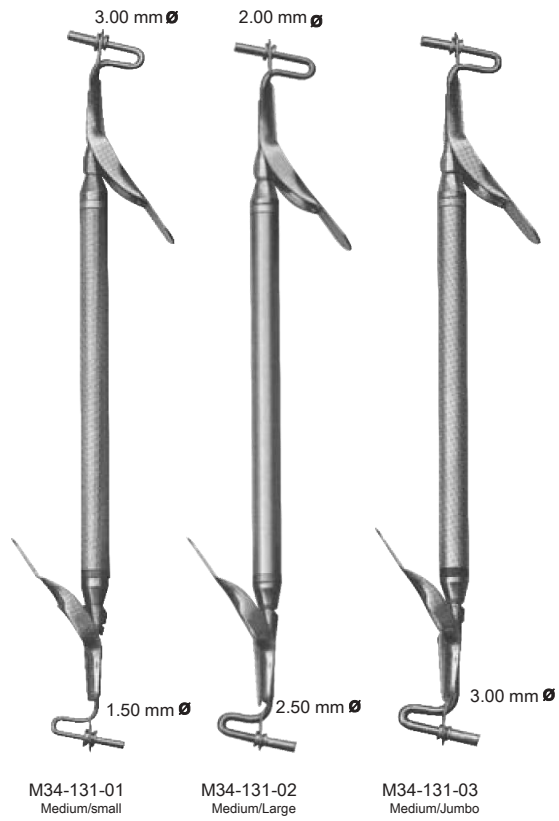



2/3

M34-134-01
30 mm \varnothing



2/3

M34-134-02
30 mm \varnothing



2/3

M34-135-01



1/1

M34-136-01



1/1

M34-137-01

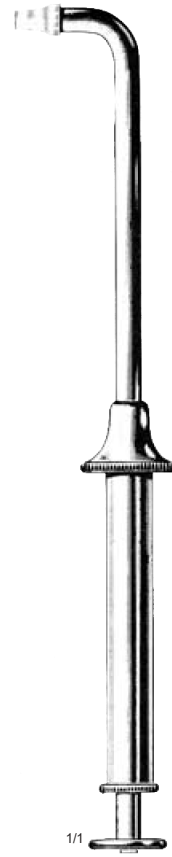

1/1

M34-138-01

M34-133-01	M34-134-01	Finger Cups for pumice, amalgam, grinding paste
M34-135-01		Mercury dispenser
M34-136-01	M34-138-01	Amalgam Guns

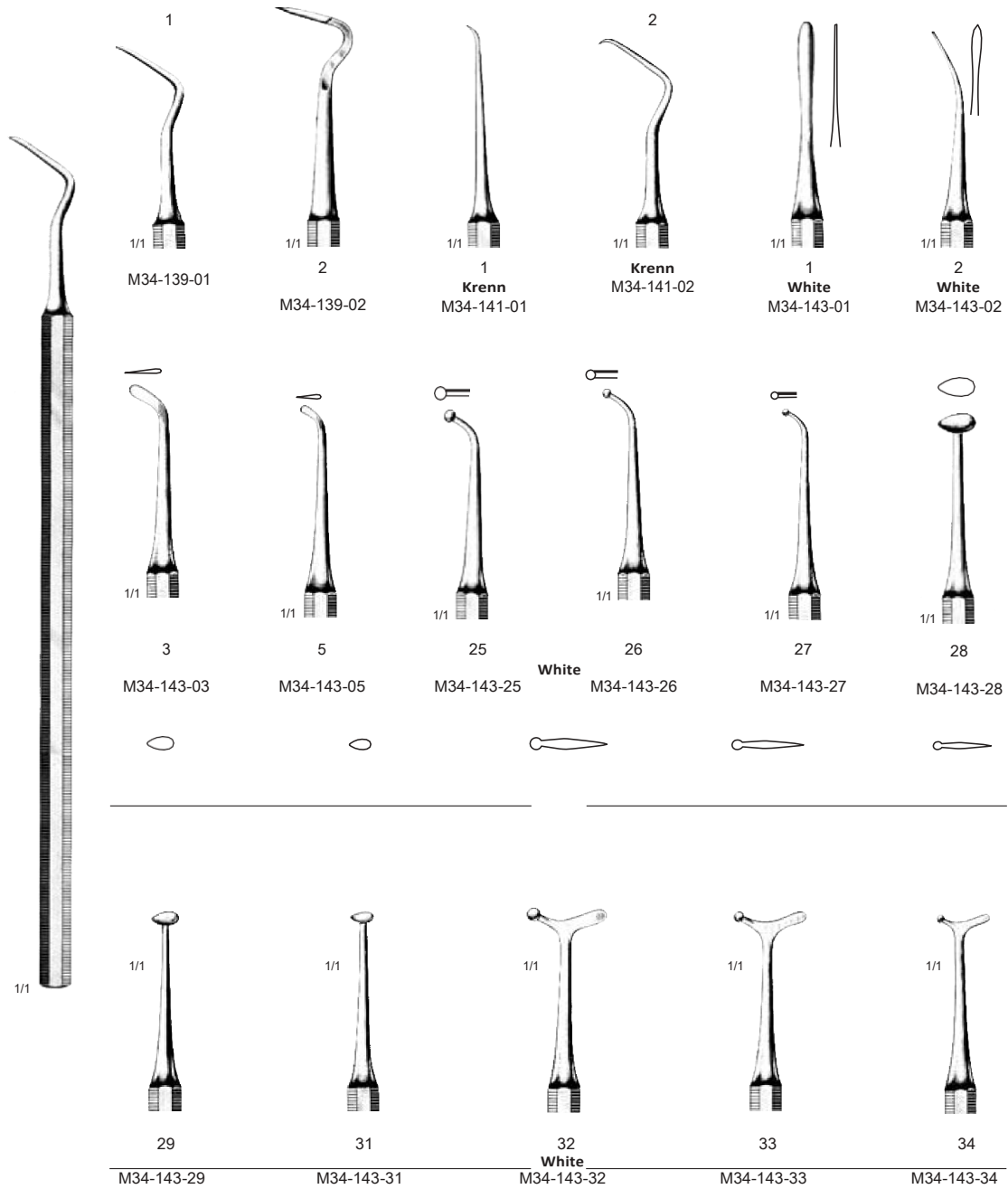

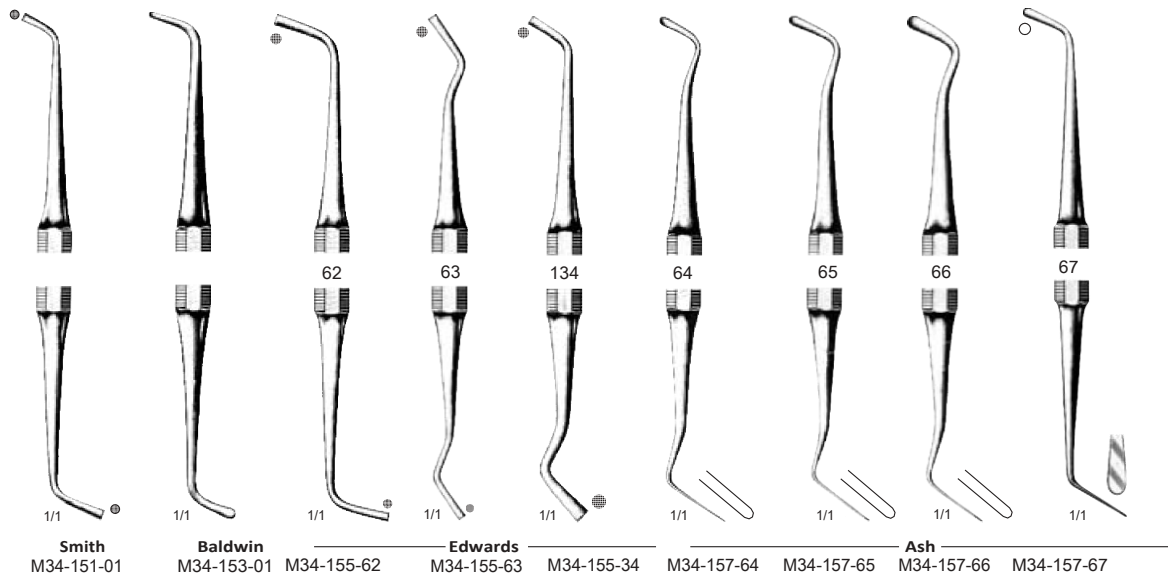
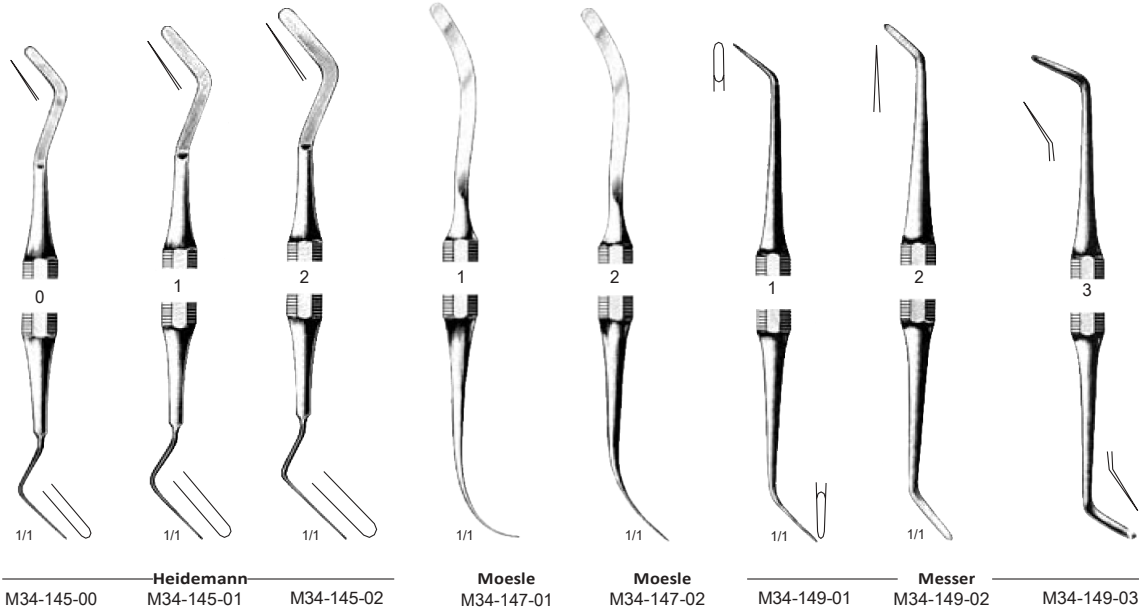

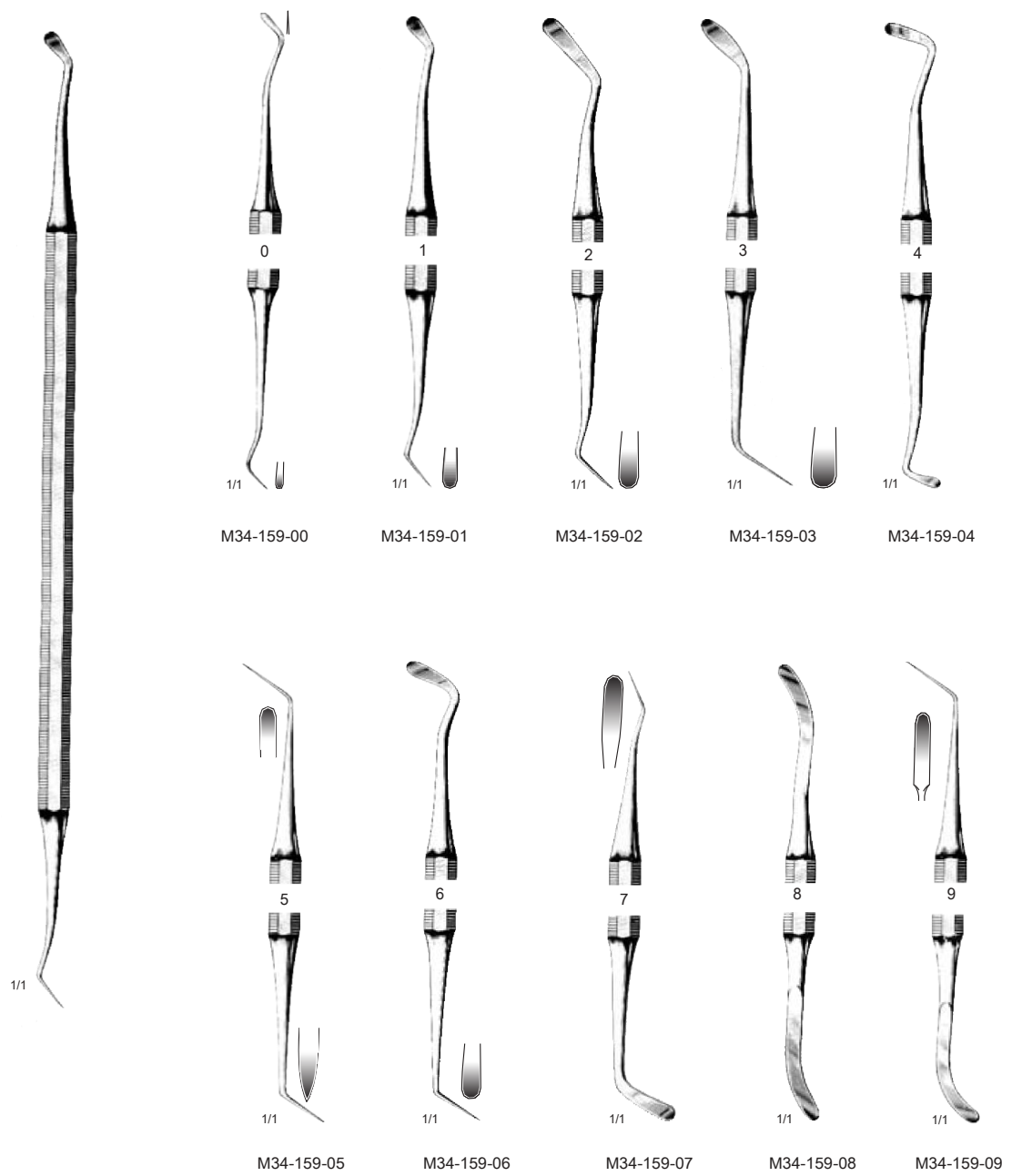

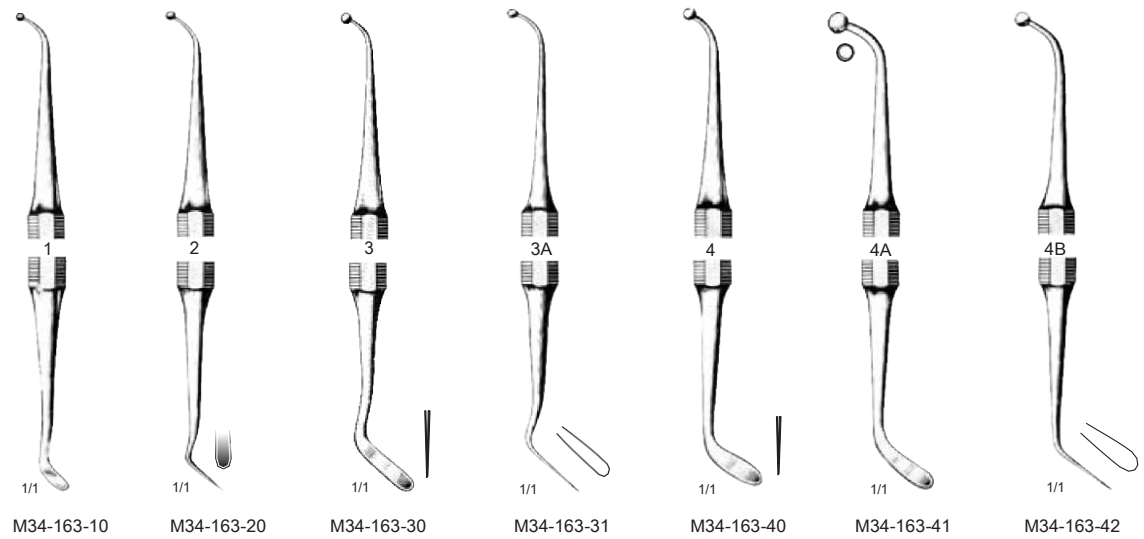
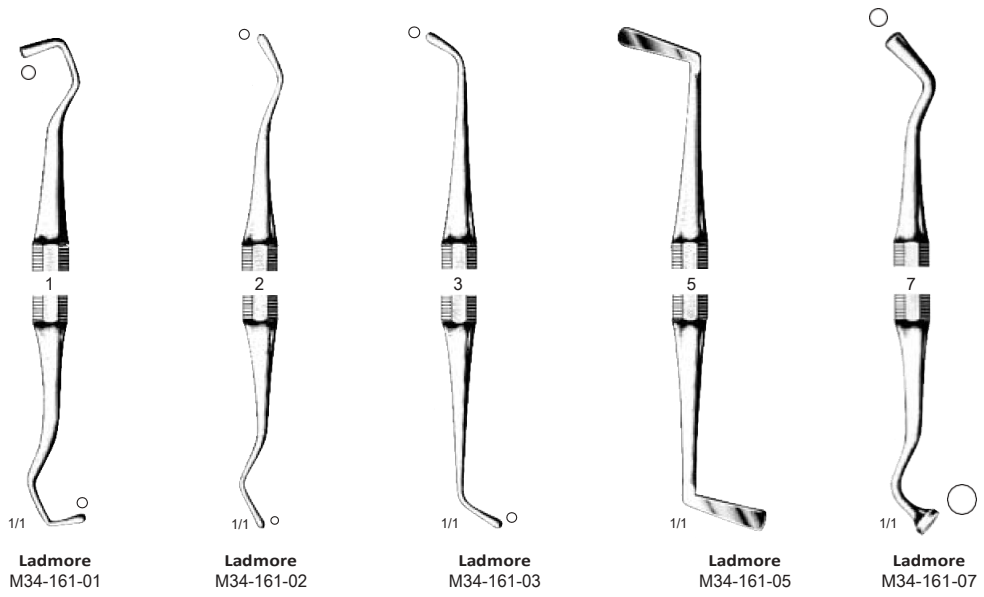

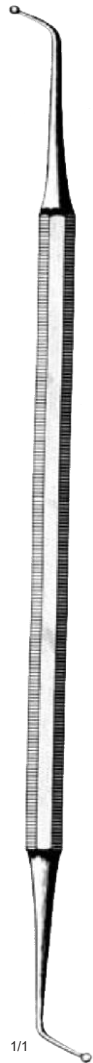

1/1



5

1/1

M34-165-50



5A

1/1

M34-165-51

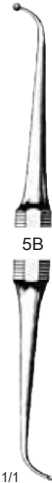

5B

1/1

M34-165-52



6

1/1

M34-165-60



7

1/1

M34-165-70



7A

1/1

M34-165-71

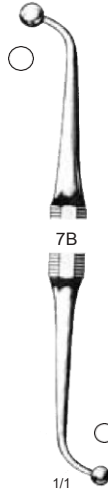

7B

1/1

M34-165-72



8

1/1

M34-165-80



9

1/1

M34-165-90

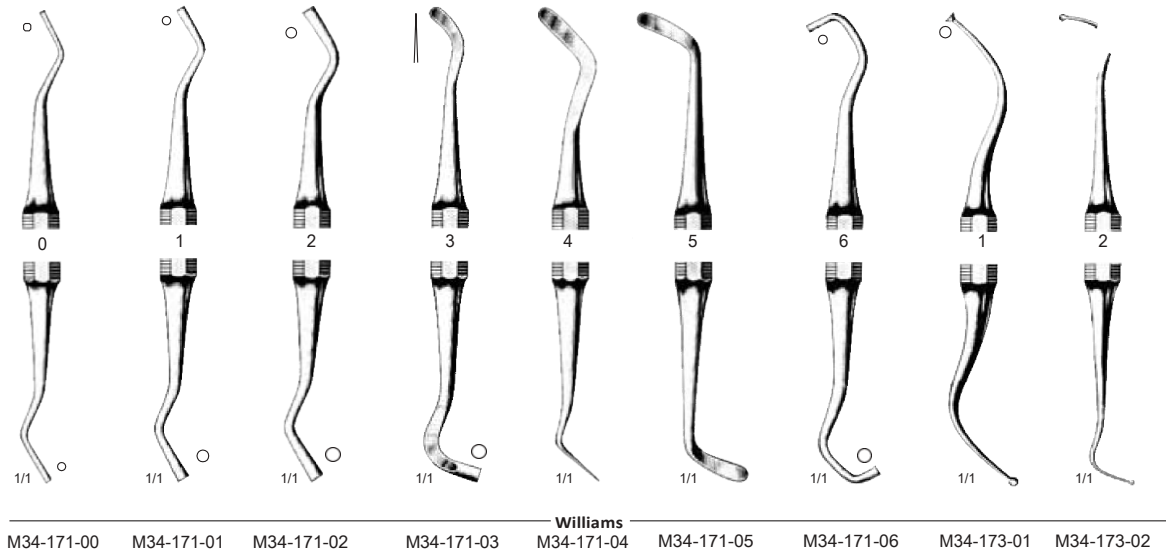
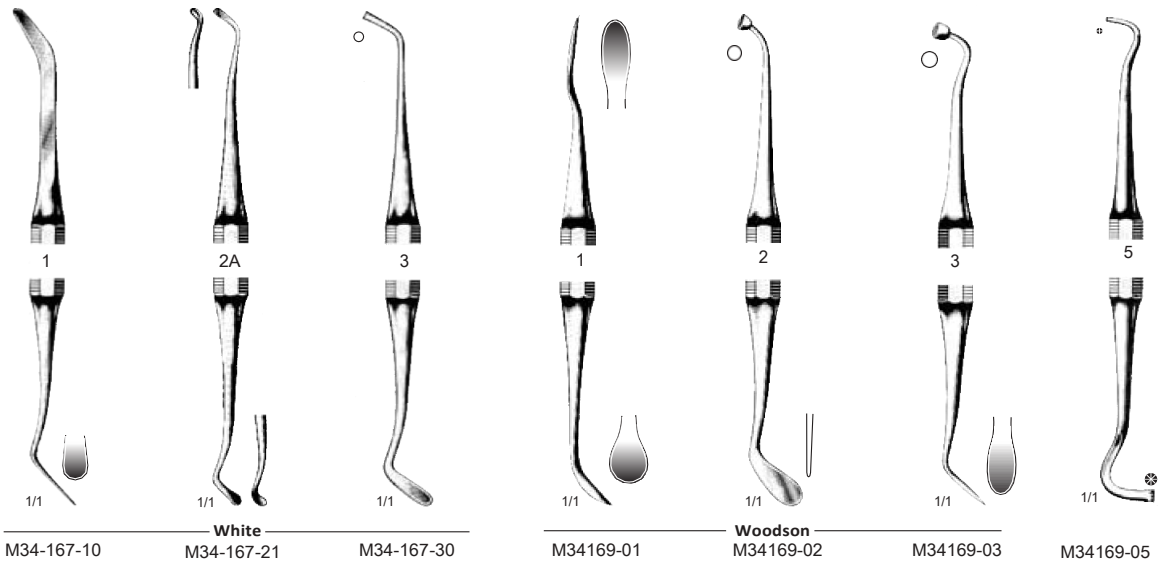

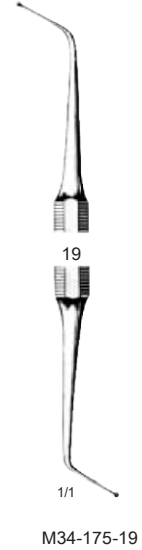
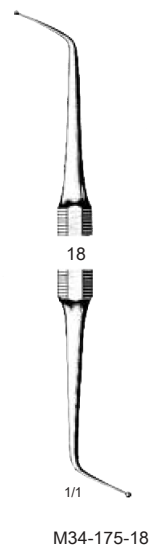
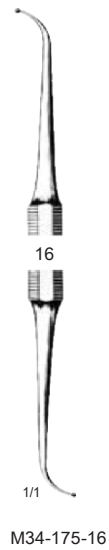
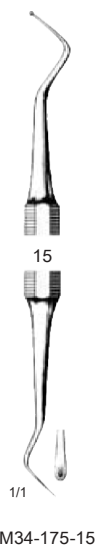
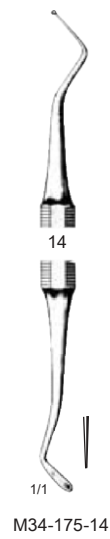
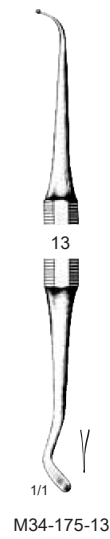
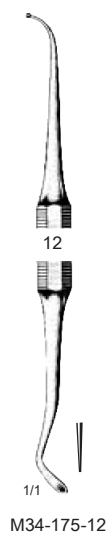
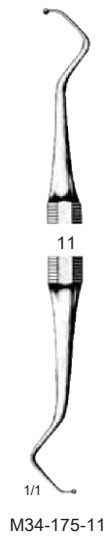
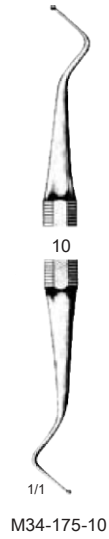
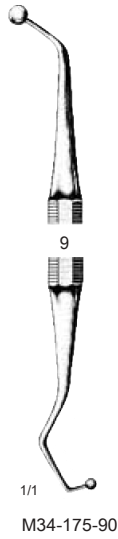

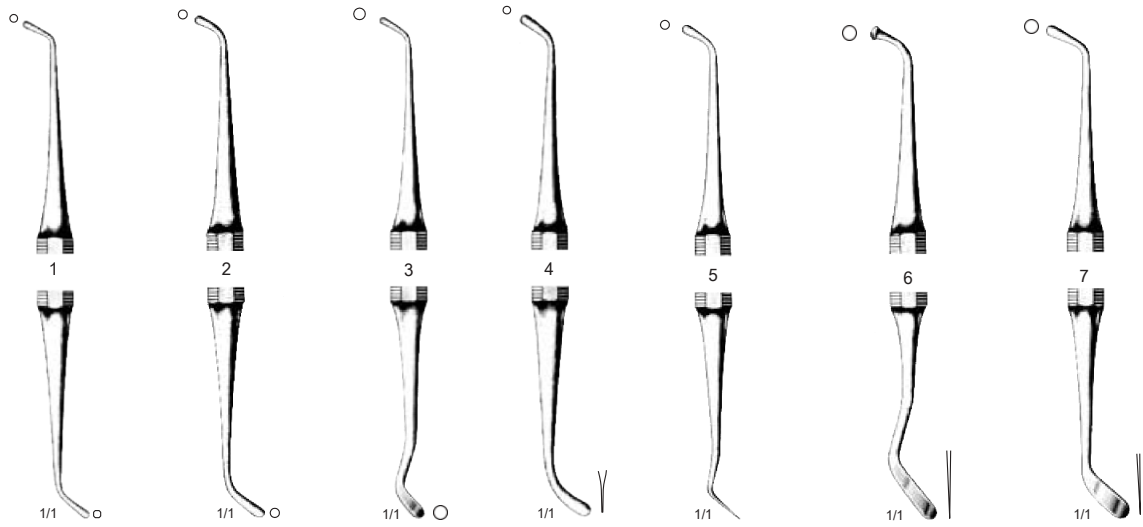

Ash

M34-177-01

M34-177-02

M34-177-03

M34-177-04

M34-177-05

M34-177-06

M34-177-07

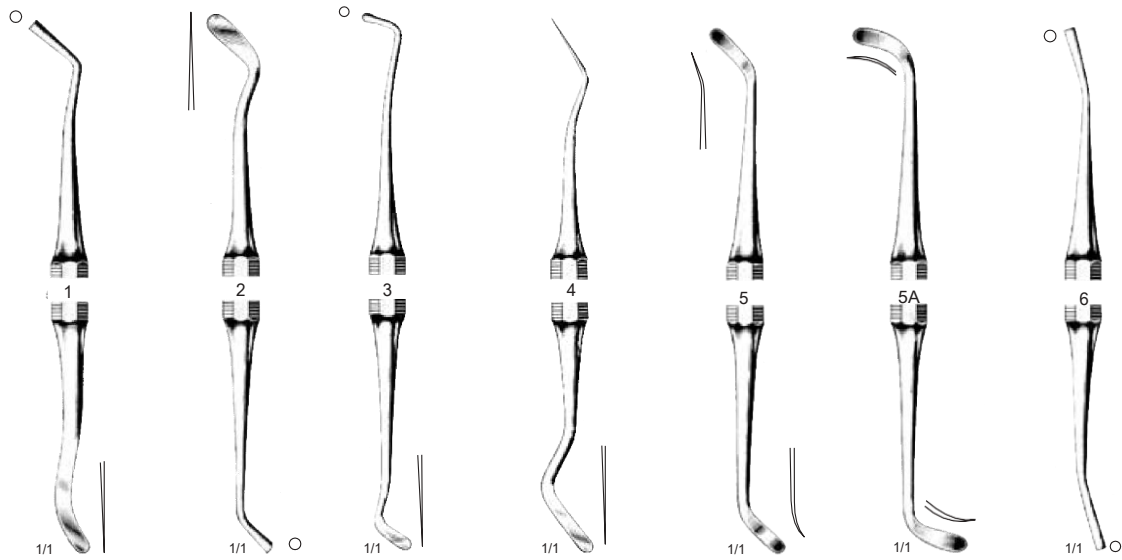

White

M34-179-01

M34-179-02

M34-179-03

M34-179-04

M34-179-05

M34-179-51

M34-179-06

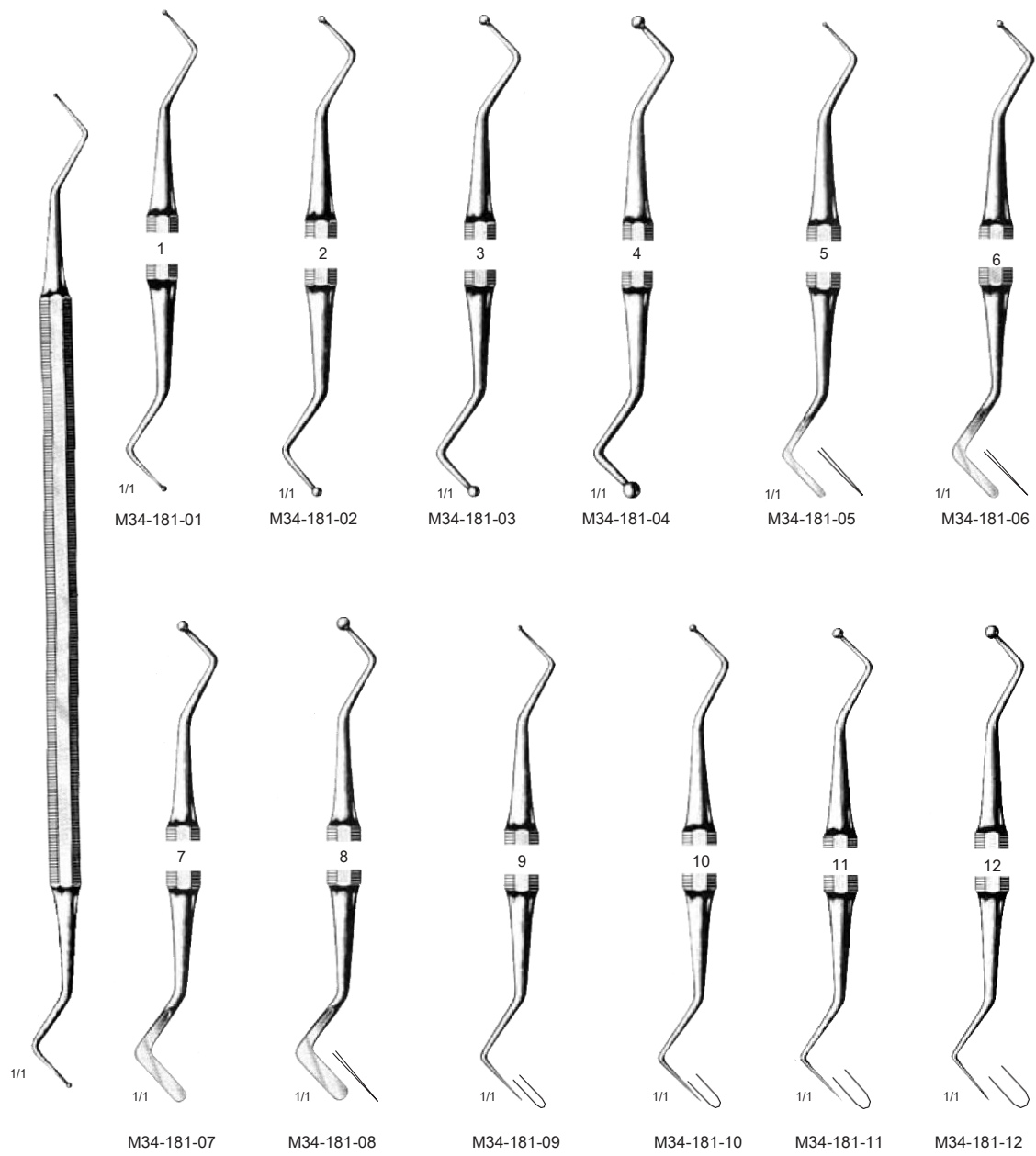

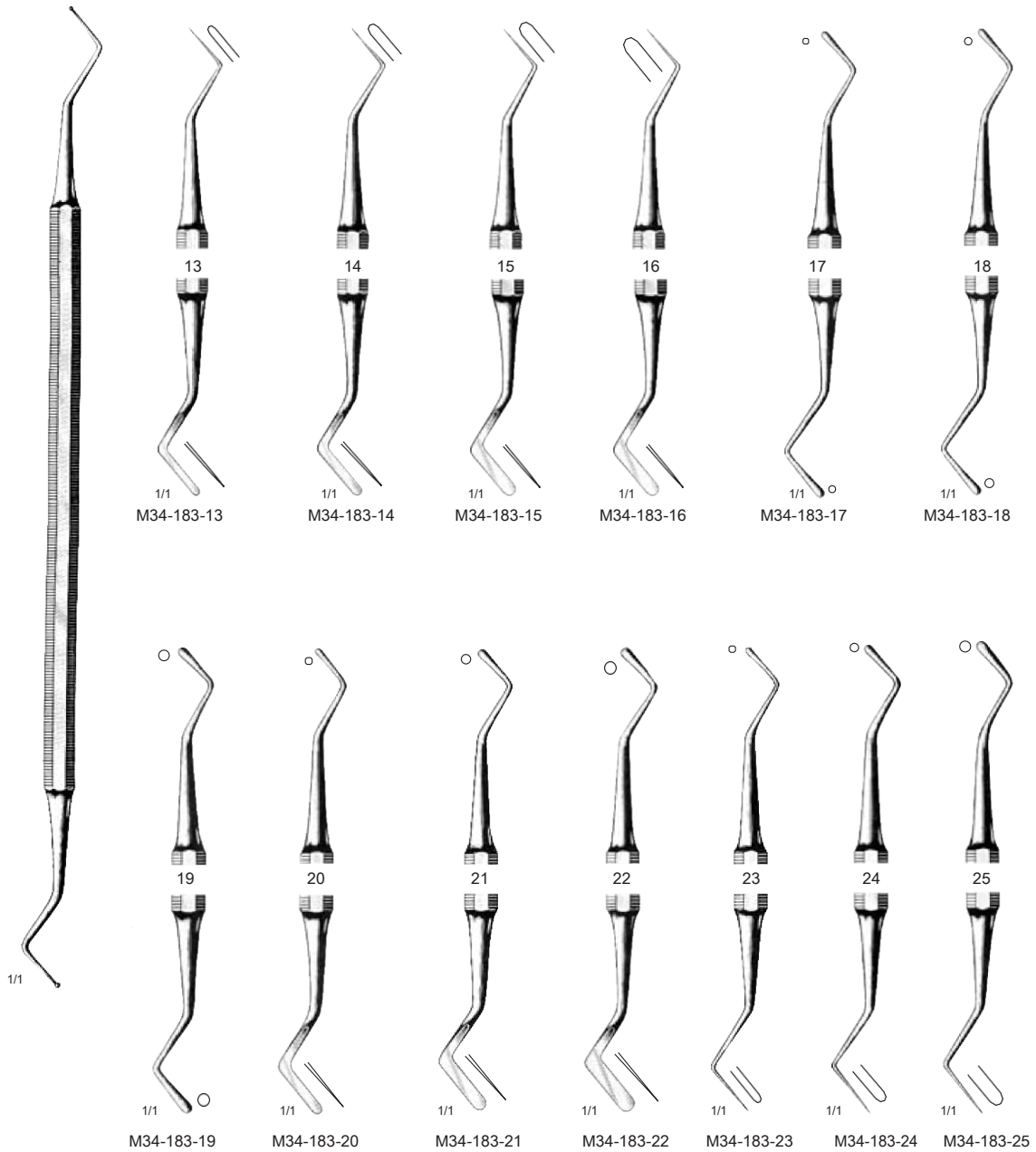

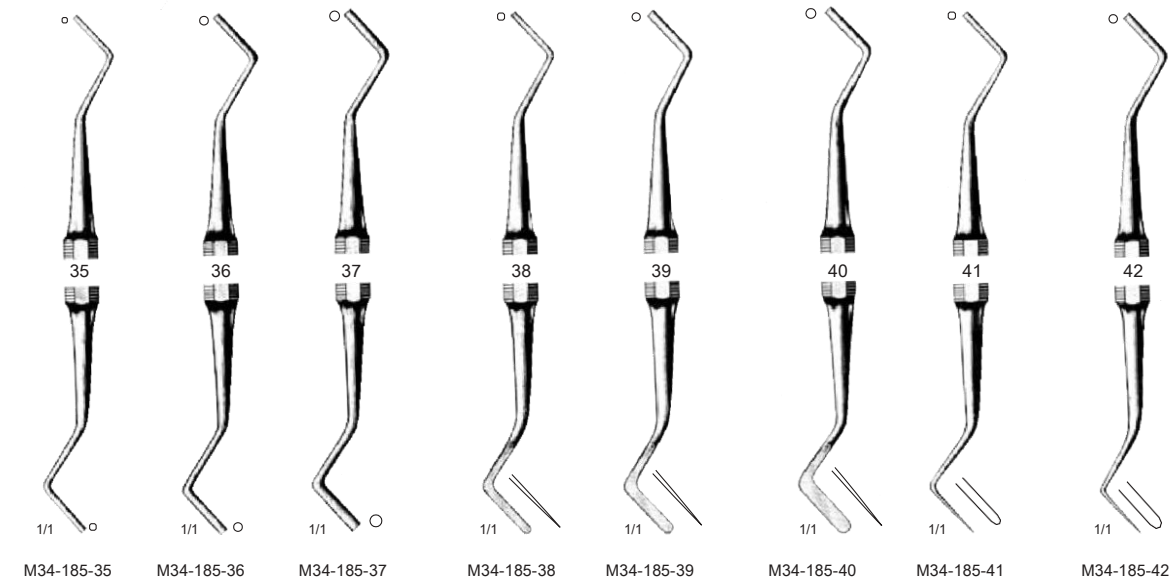
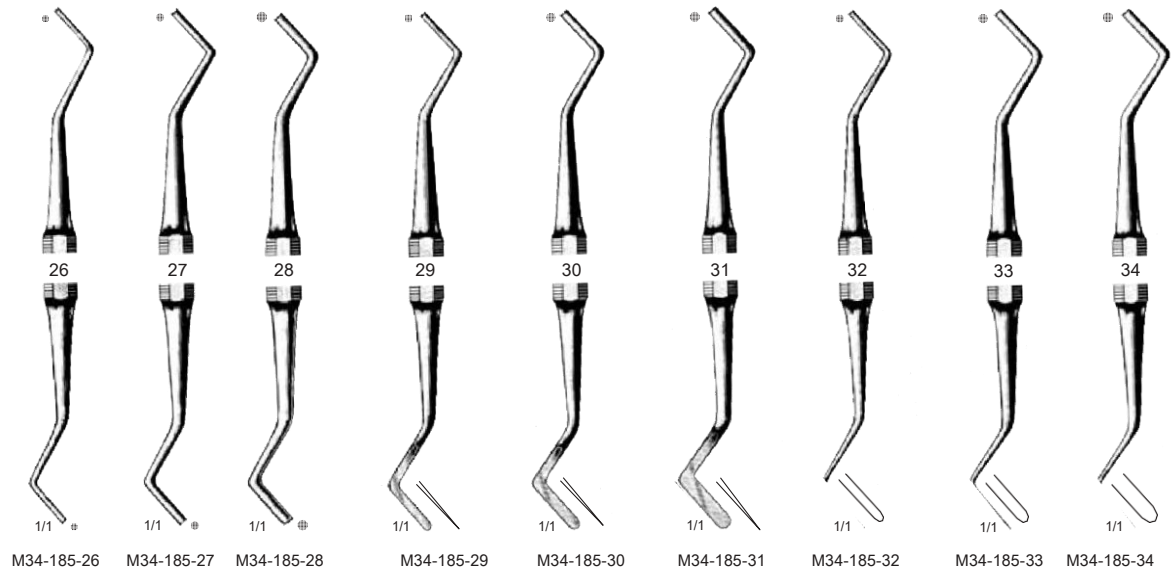

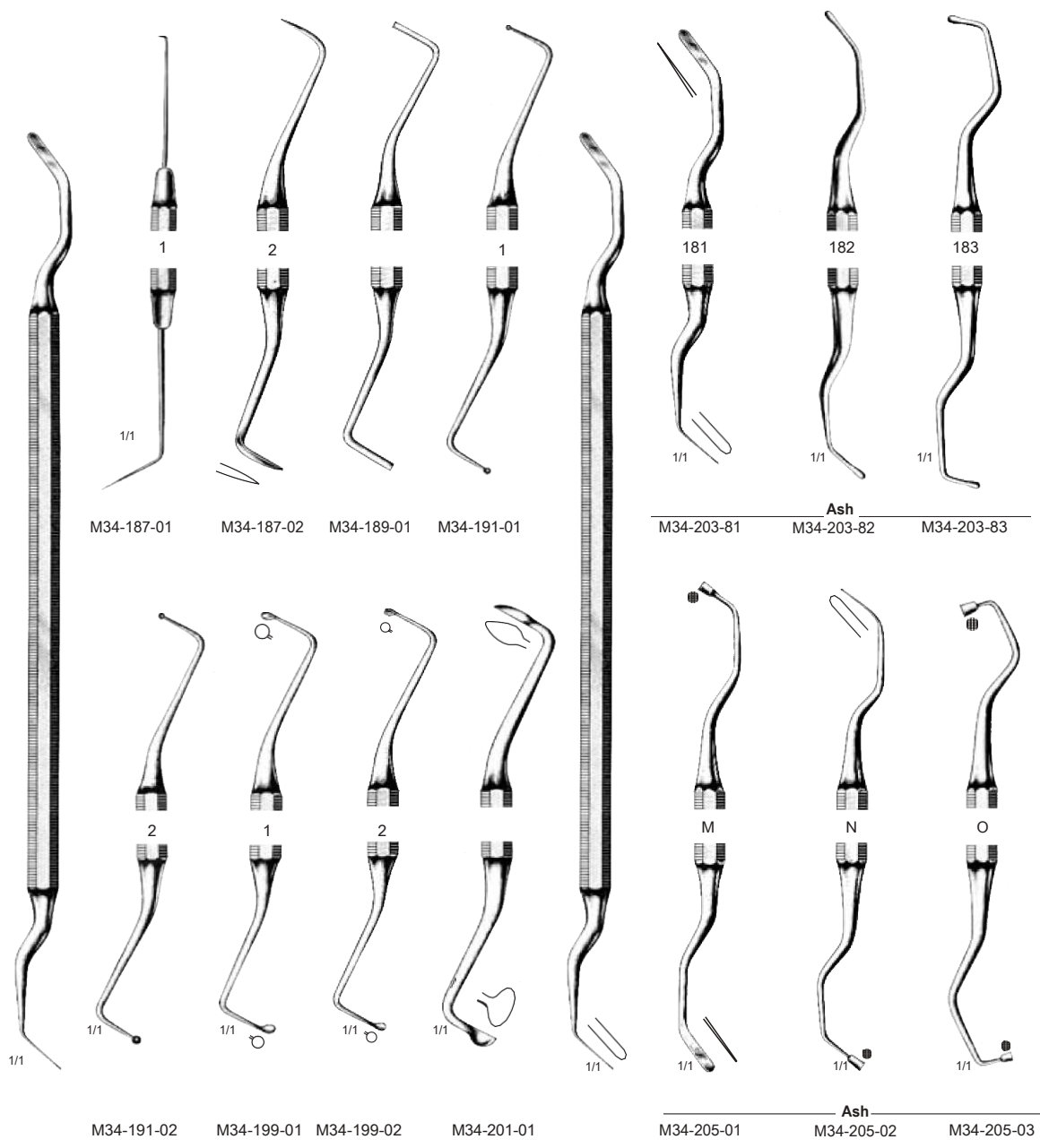

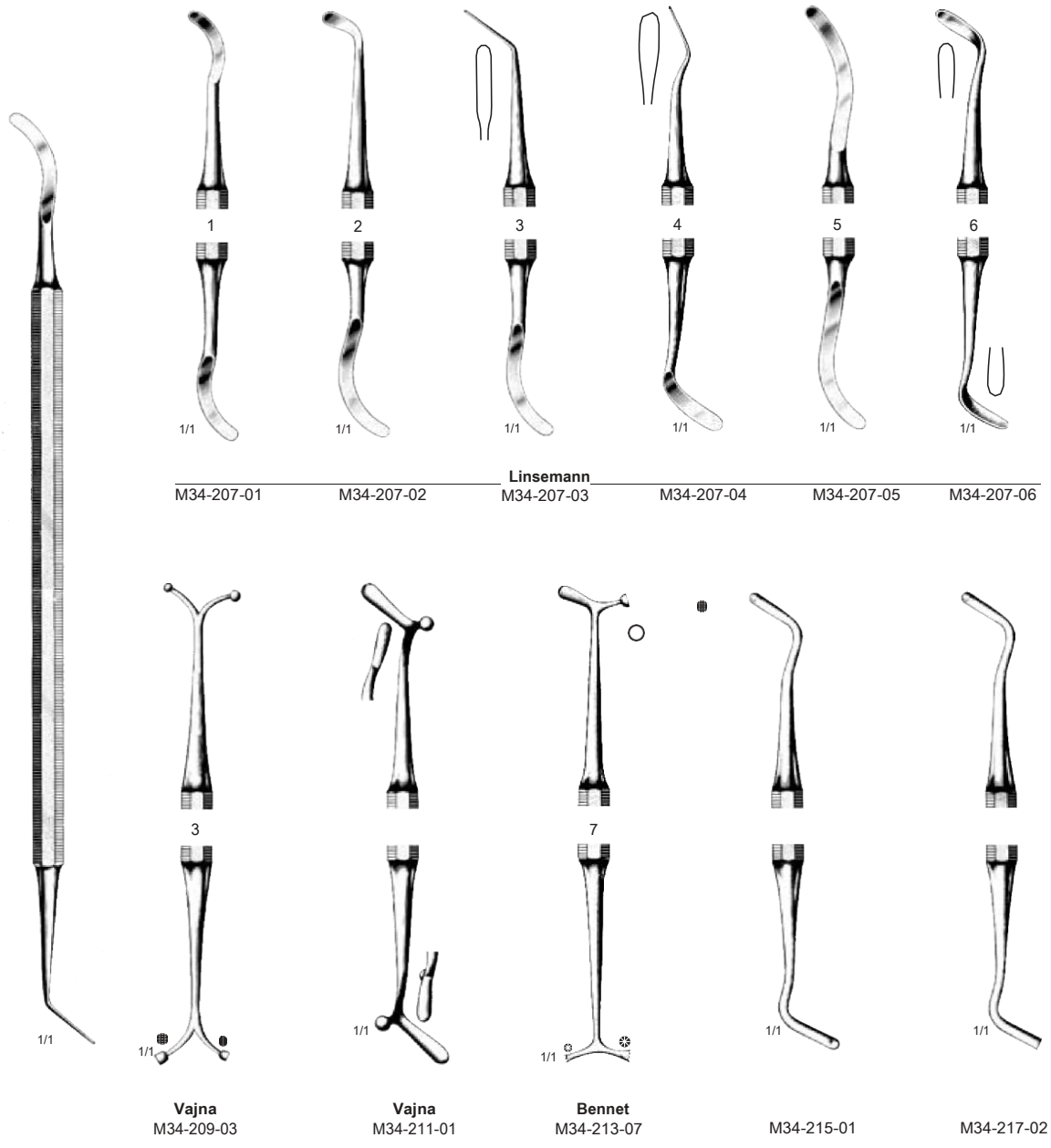

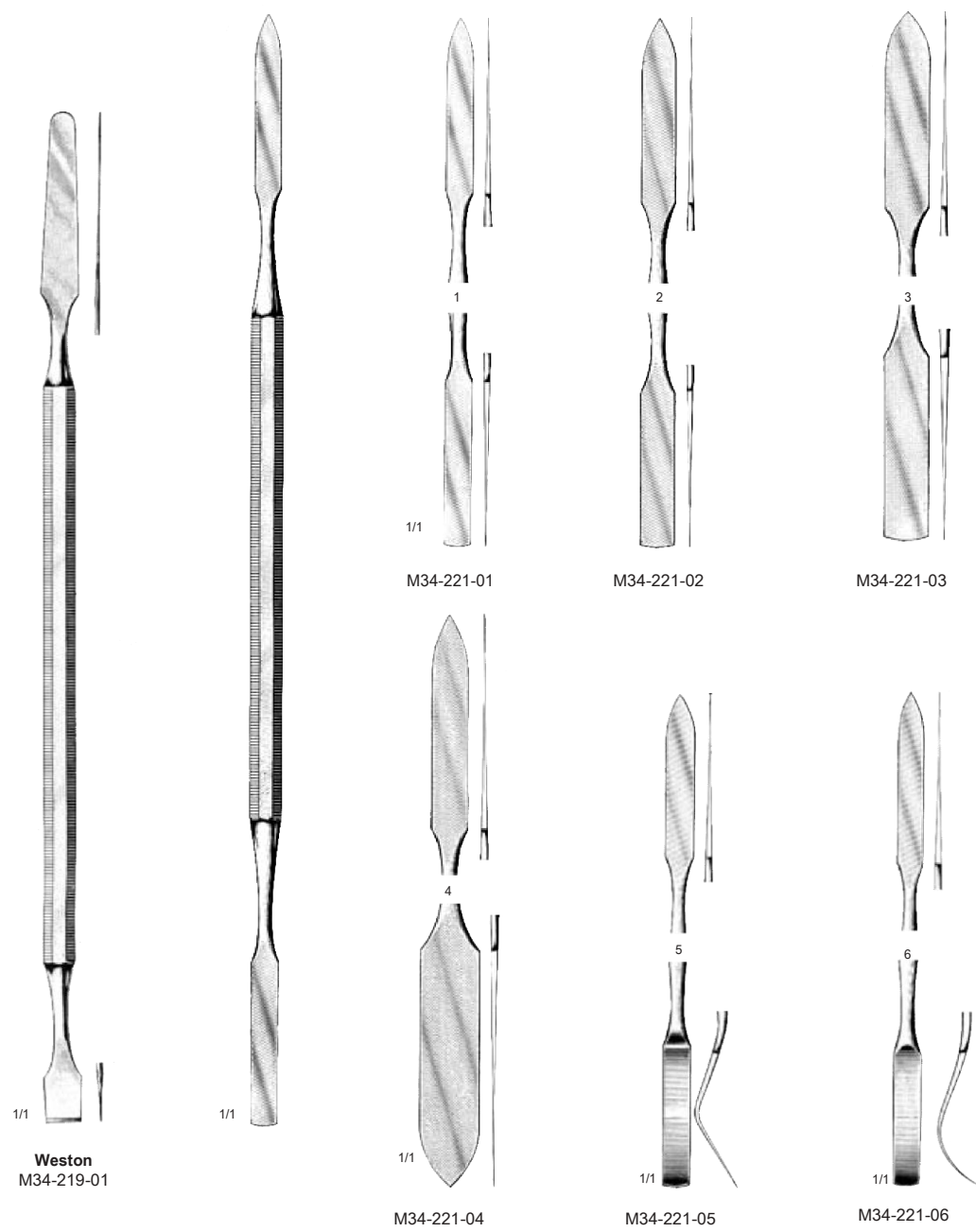

M34-219-01 M34-221-05 Cement Spatula

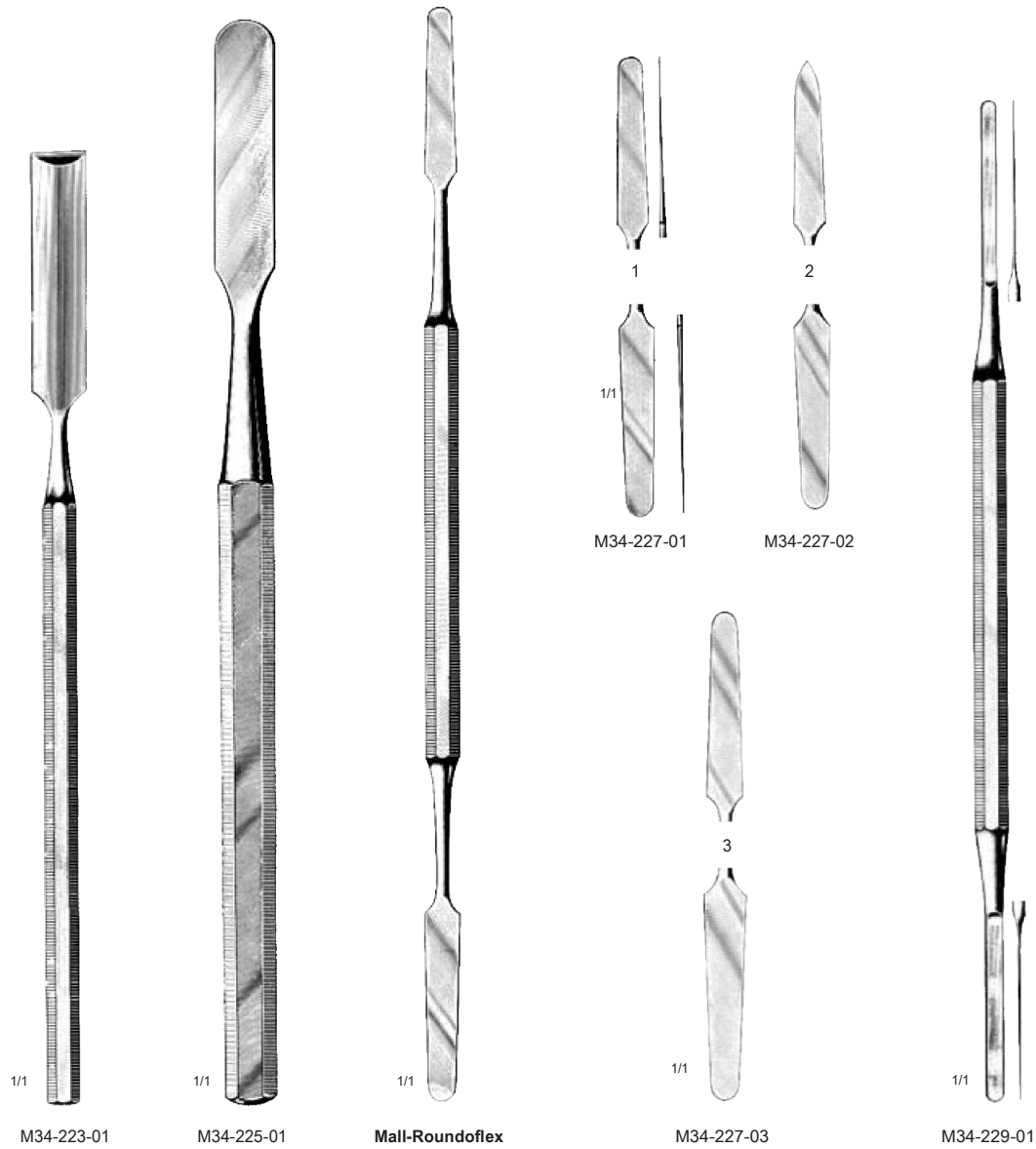

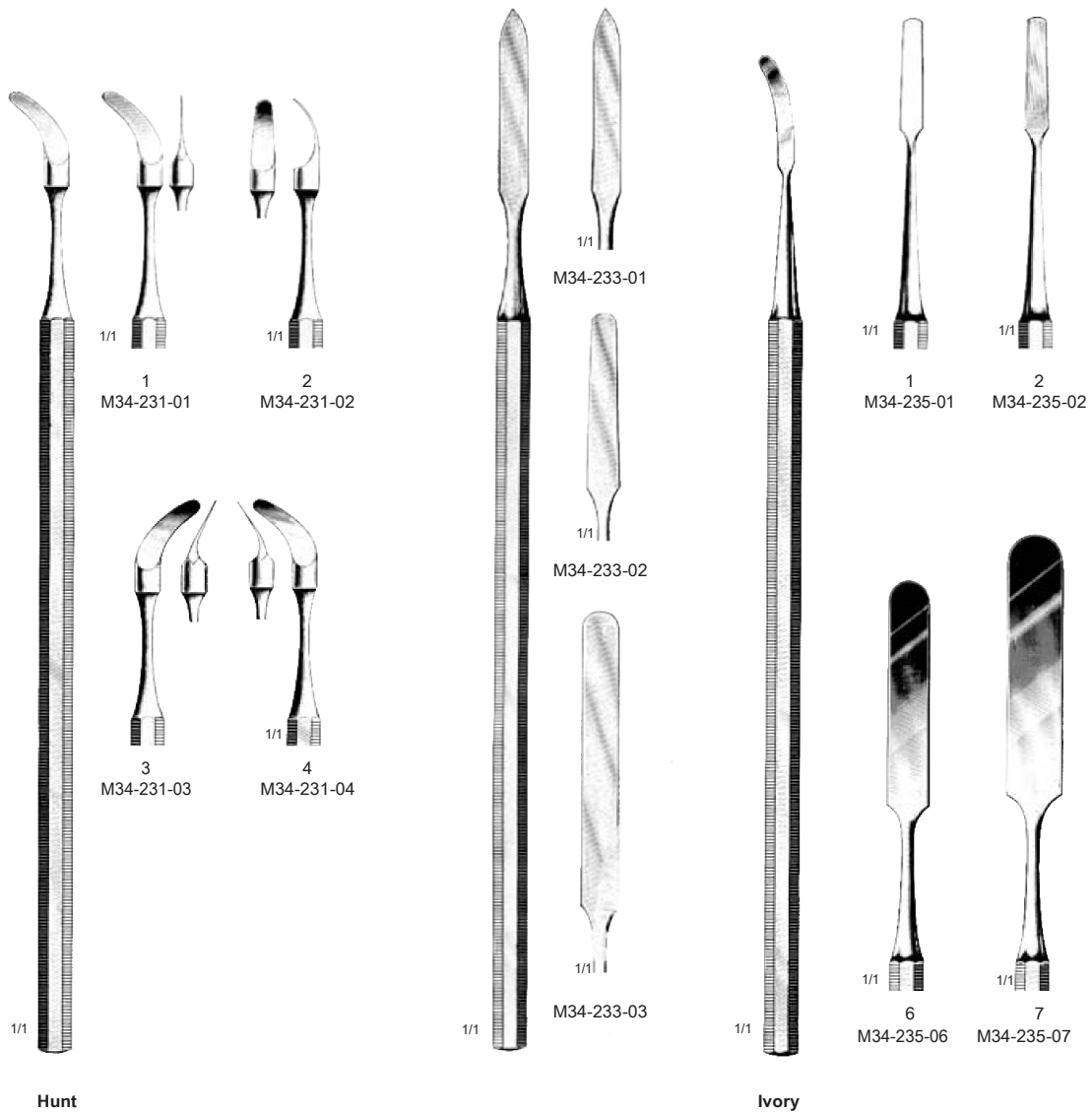



150 X 3 mm Ø
M34-172-03



130 X 2 mm Ø M34-237-02
185 x 2 mm Ø M34-239-02
210 x 2 mm Ø M34-241-02



M34-243-02
M34-245-02
M34-247-02



100 X 2 mm Ø M34-249-02
130 x 2 mm Ø M34-251-02
150 x 2 mm Ø M34-253-02



M34-255-02
M34-257-02
M34-259-02



150 X 3 mm Ø M34-261-03
185 x 3 mm Ø M34-263-03
210 x 3 mm Ø M34-265-03



130 X 4 mm Ø M34-267-04
155 x 4 mm Ø M34-269-04



17.5 cm / 7"
M34-207-17

19 cm / 7½" M34-271-19
22 cm / 8¼" M34-273-22
25 cm / 10" M34-275-25
28 cm / 11" M34-277-28
30 cm / 12" M34-279-30
35 cm / 14" M34-281-35



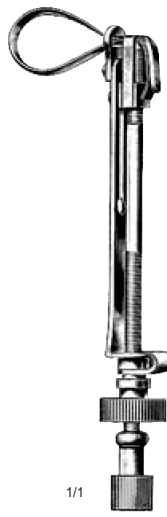

1/1

Didner
M34-283-01



1/1

Ivory
M34-285-01

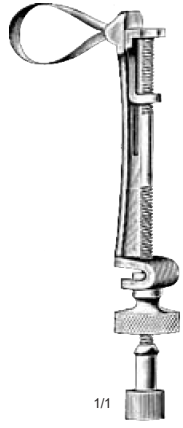

1/1

Ivory
M34-287-01



1/1

Ivory
M34-289-01



- M 34-291-20 = 20 mm
- M 34-291-25 = 25 mm
- M 34-291-30 = 30 mm



1/1

Ivory
M34-293-01

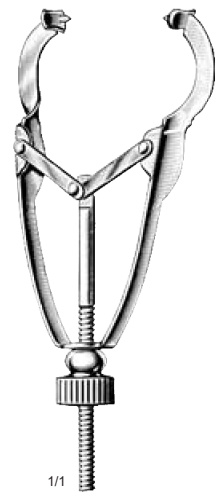

1/1

Ivory
M34-295-01

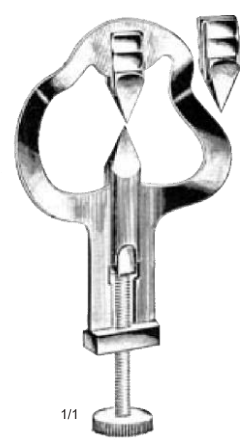

1/1

Ivory
M34-297-01

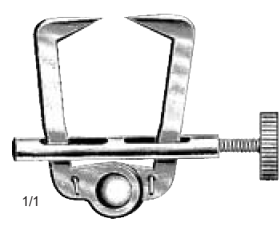

1/1

Elliot
M34-299-01

M34-283-01	M34-289-01	Matrix Retainer
M34-291-20	M34-291-30	Rubber-dam Holder
M34-293-01	M34-295-01	Matrix Retainer
M34-297-01	M34-299-01	Separators

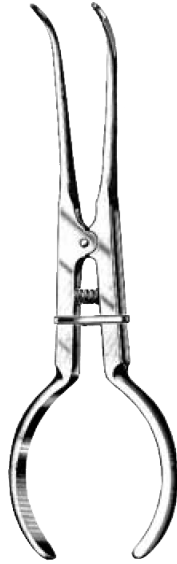

17 cm / 6¾"

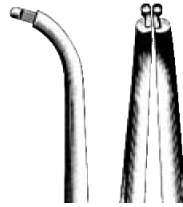

M34-301-17

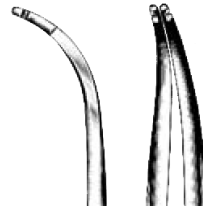

M34-303-17

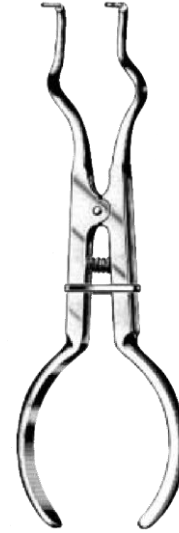

Brewer
17 cm / 6¾"
M34-305-17



Ivory
17 cm / 6¾"
M34-307-17

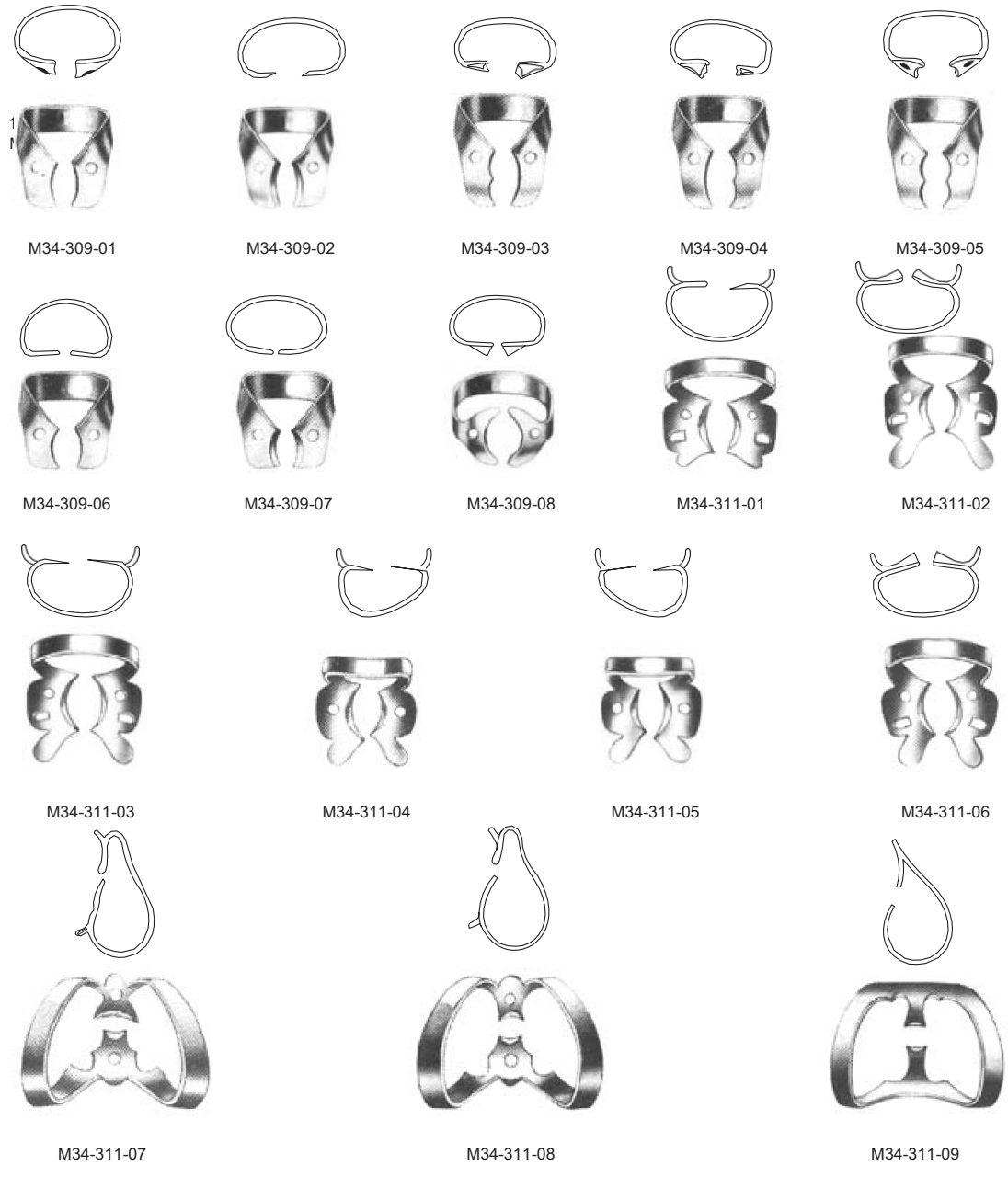

M34-309-01	M34-309-05	Molar Clamps
M34-309-06	M34-309-08	Bicuspid Clamps
M34-311-01	M34-311-06	Molar Clamps
M34-311-07	M34-311-09	Labial Clamps



M34-313-10



M34-313-11



M34-313-12



M34-313-13



M34-313-14



M34-313-15



M34-313-16



M34-313-17



M34-313-18



M34-313-19



M34-313-20



M34-313-21



M34-313-22



M34-313-23



M34-313-24



M34-313-25



M34-313-26



M34-313-27

M34-313-10	M34-313-14	Molar Clamps
M34-313-15	M34-313-20	Molar Clamps
M34-313-21	M34-313-27	Bicuspids Clamps

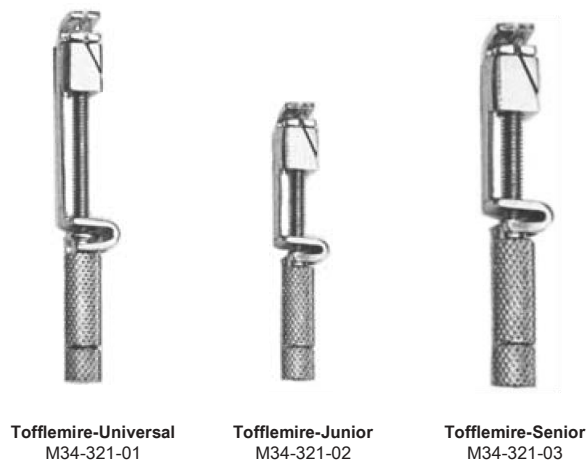
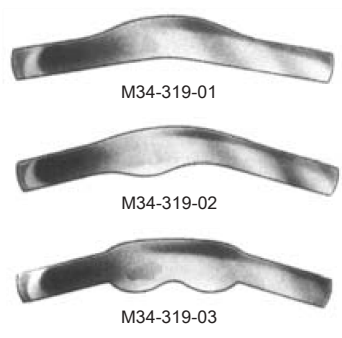
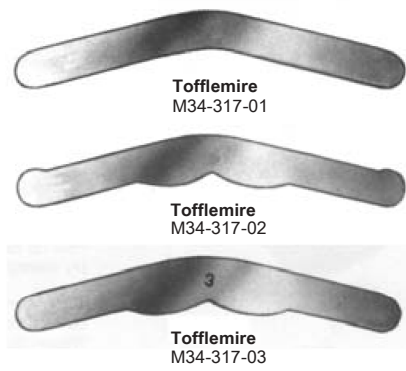
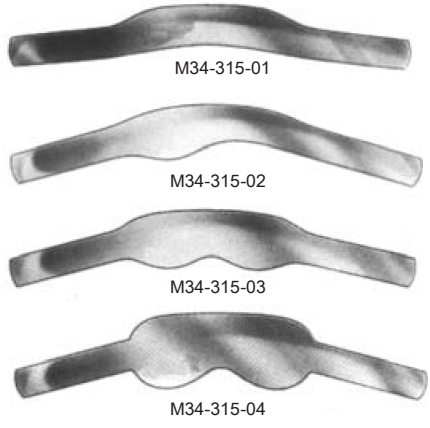

M34-315-01	M34-319-03	Matrix Bands
M34-321-01	M34-321-03	Matrix Retainer

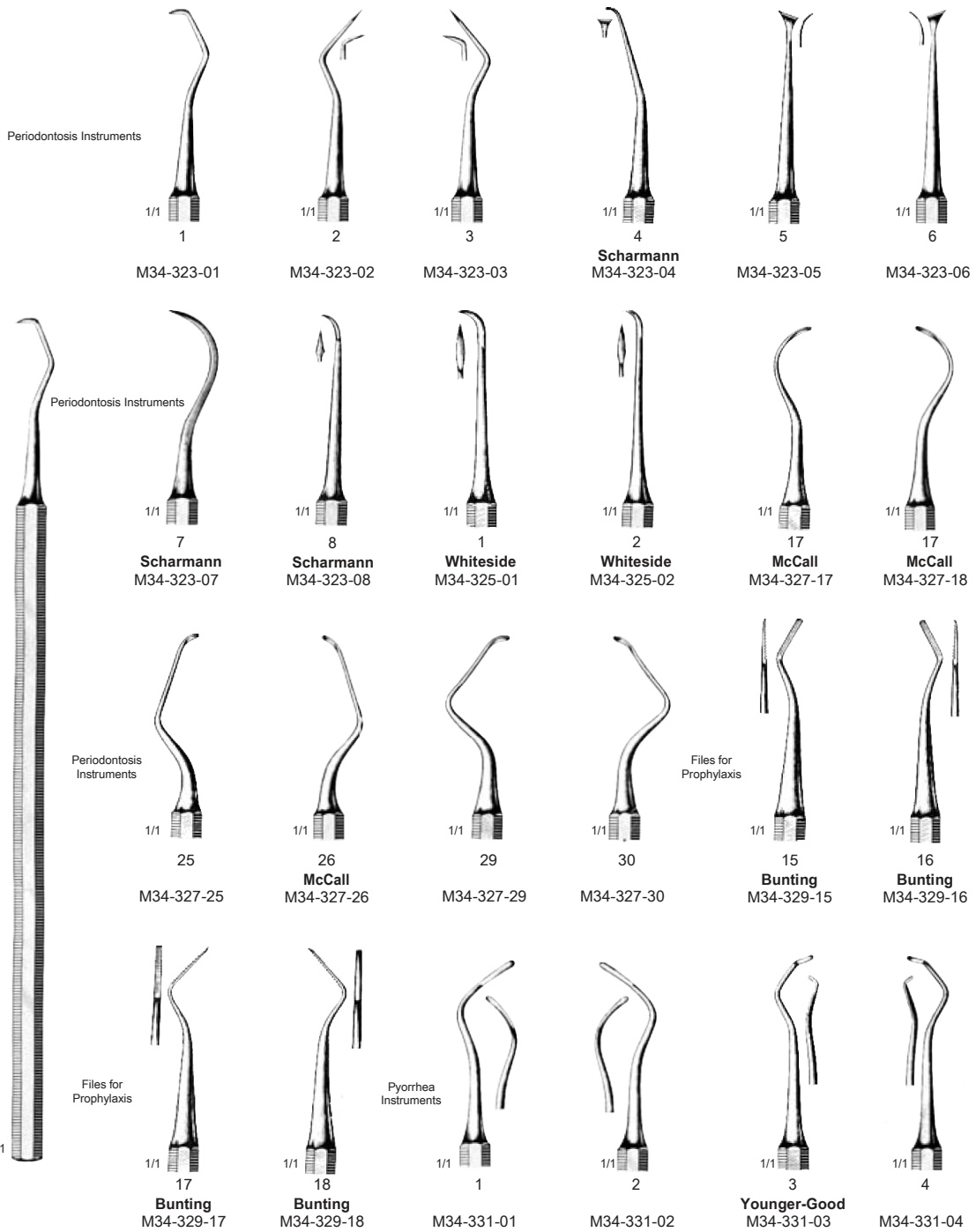

Scalers for Periodontosis and Pyorrhea

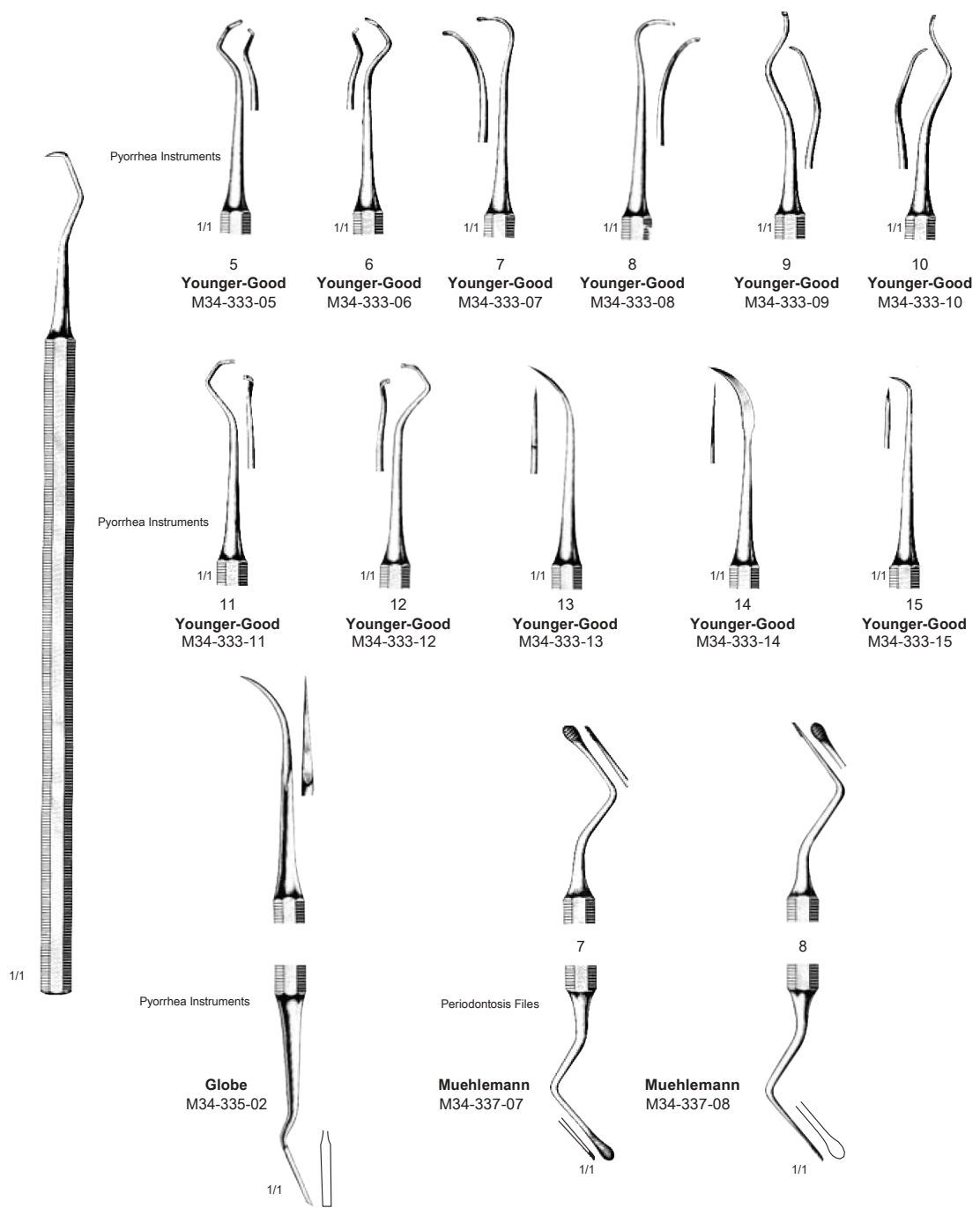

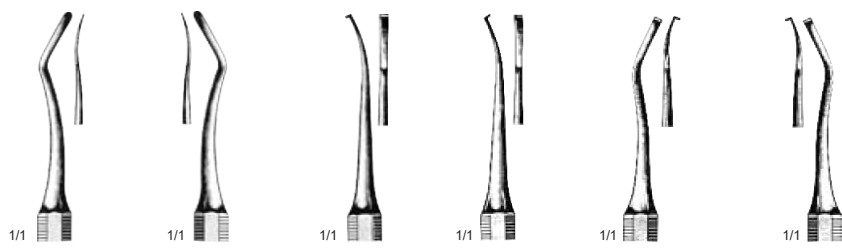
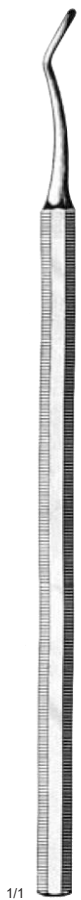

Black					
1	2	3	4	5	6
M34-339-01	M34-339-02	M34-339-03	M34-339-04	M34-339-05	M34-339-06
15	15	15	15	15	15
8	8	F	B	8	8
6	6			6	6
L	R			L	R

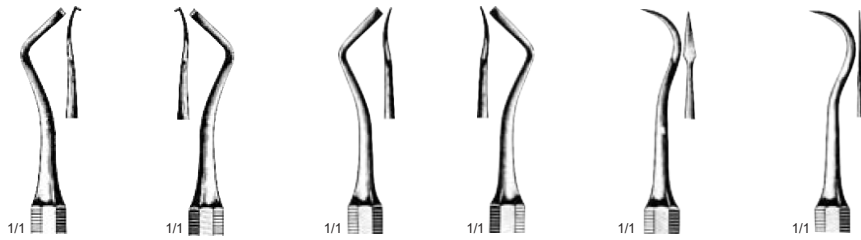

Black					
7	8	9	10	11	12
M34-339-07	M34-339-08	M34-339-09	M34-339-10	M34-339-11	M34-339-12
15	15	15	15	25	20
8	8	8	8		
6	12	12	12		
R	R	L	R		

Scalers for Periodontosis and Pyorrhea

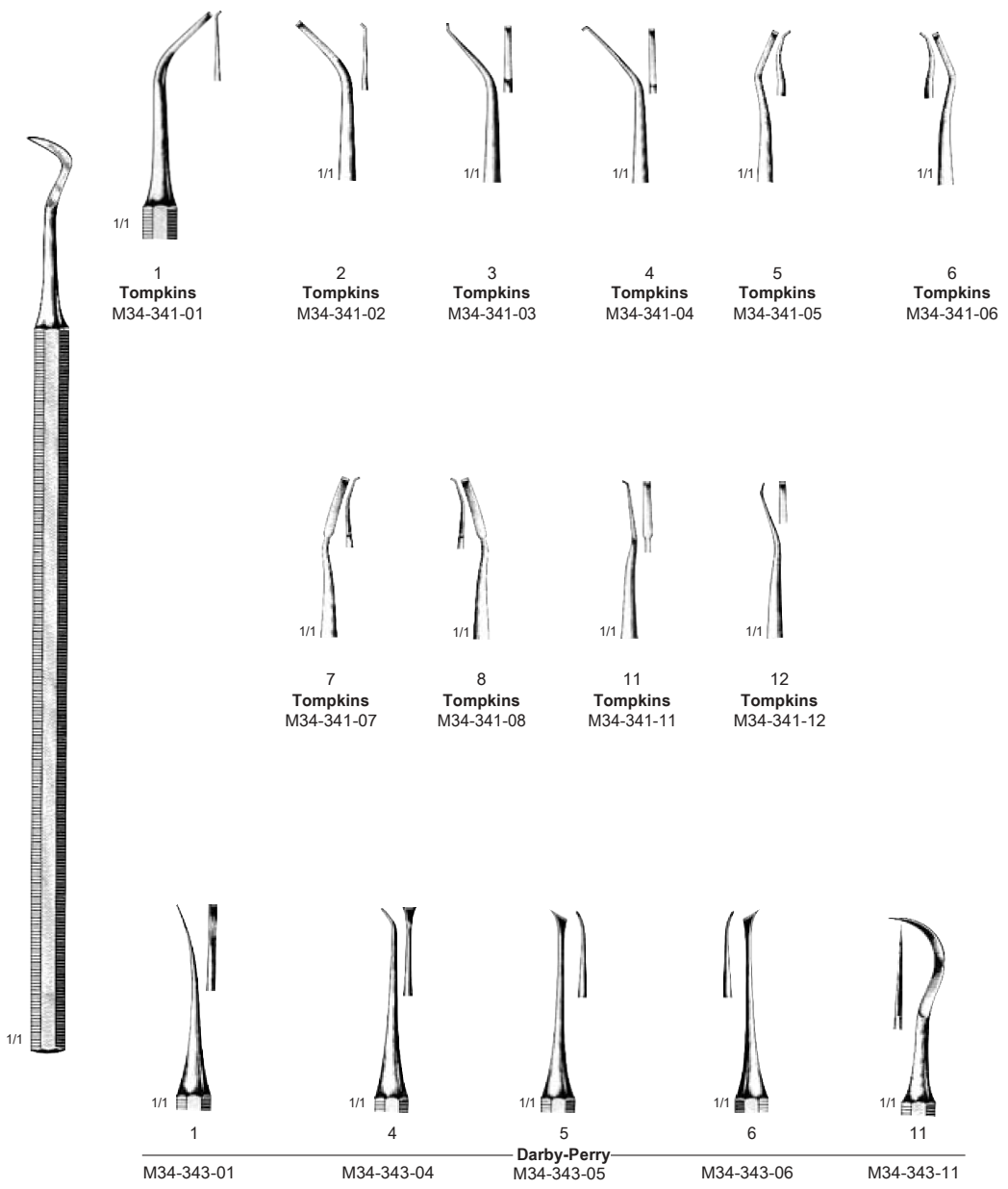

M34-341-01 M34-343-11 Pyorrhea Instruments

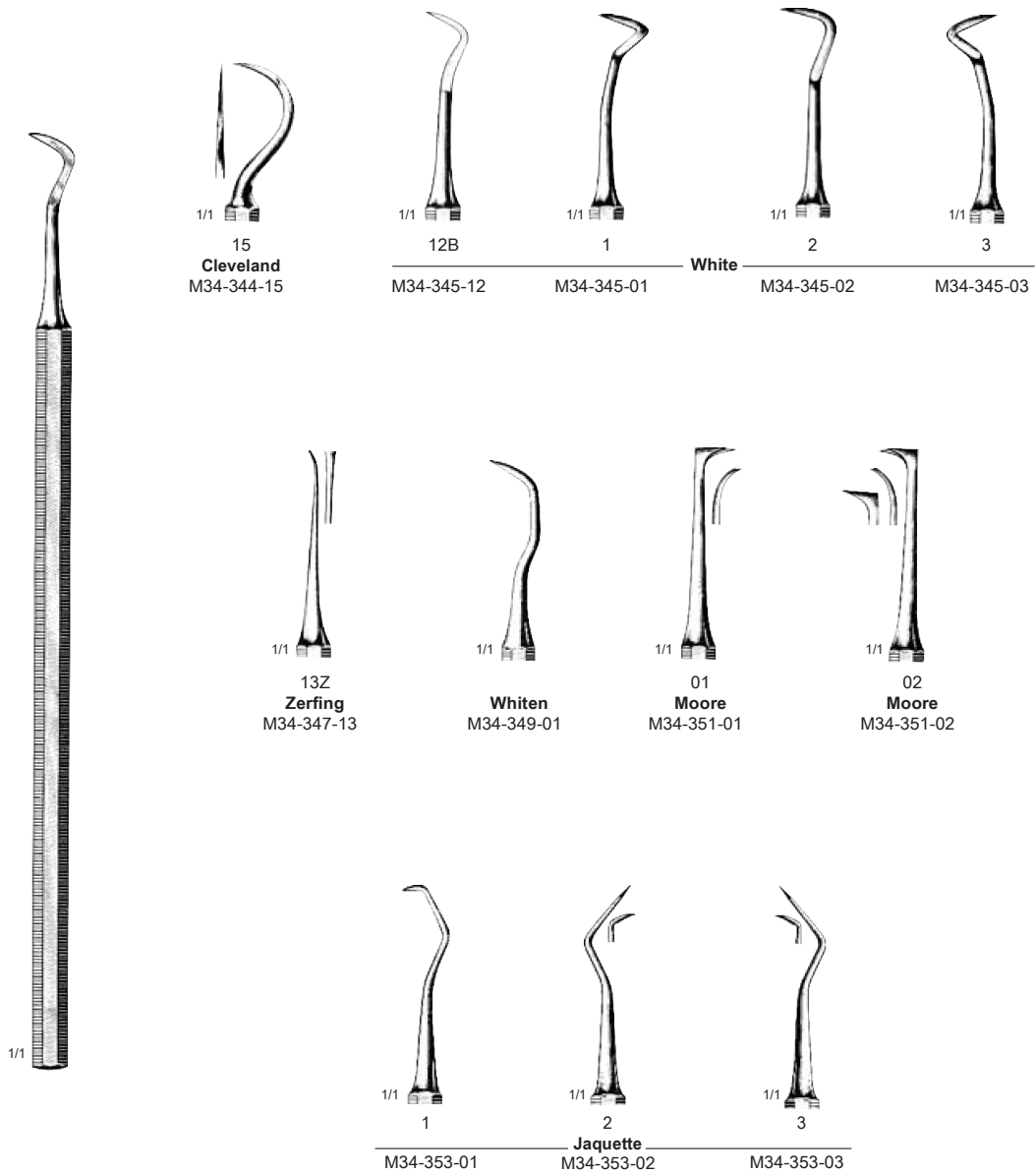

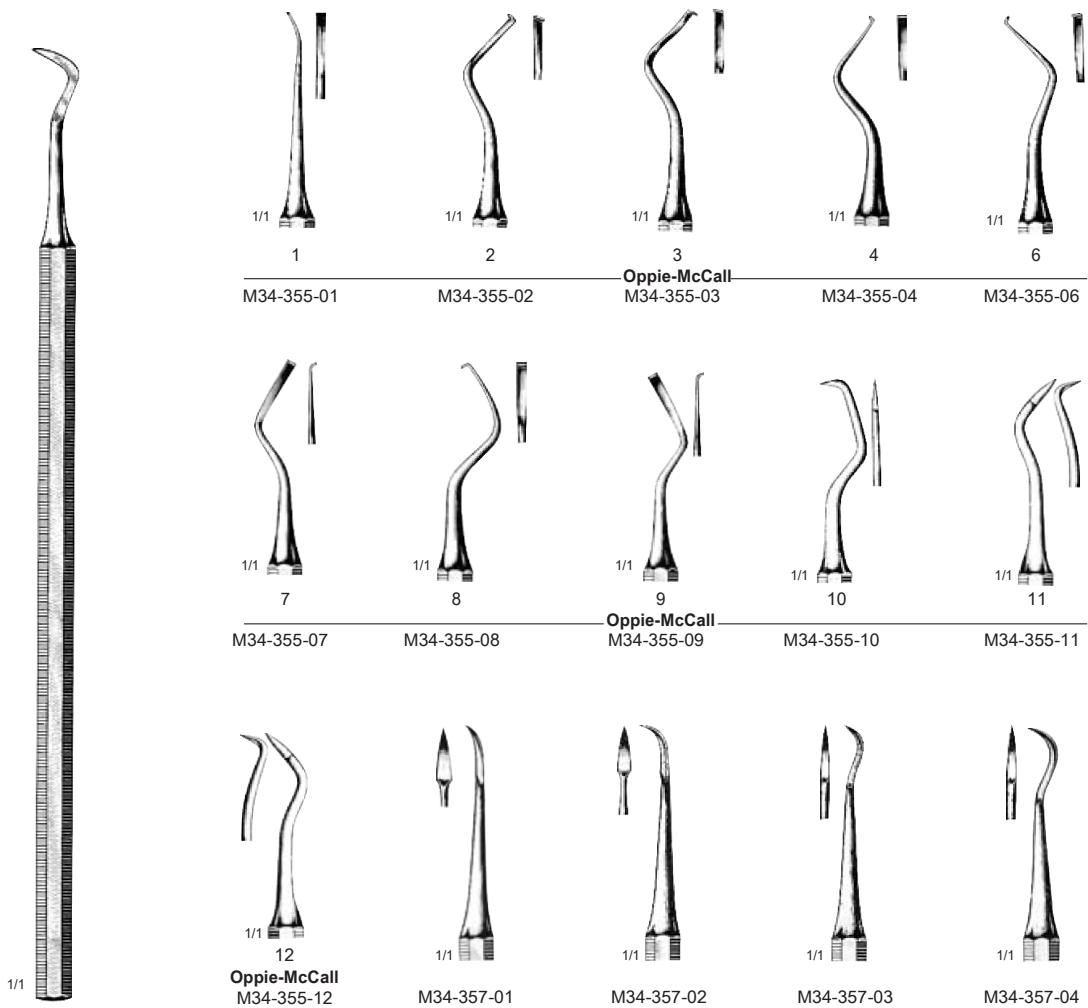

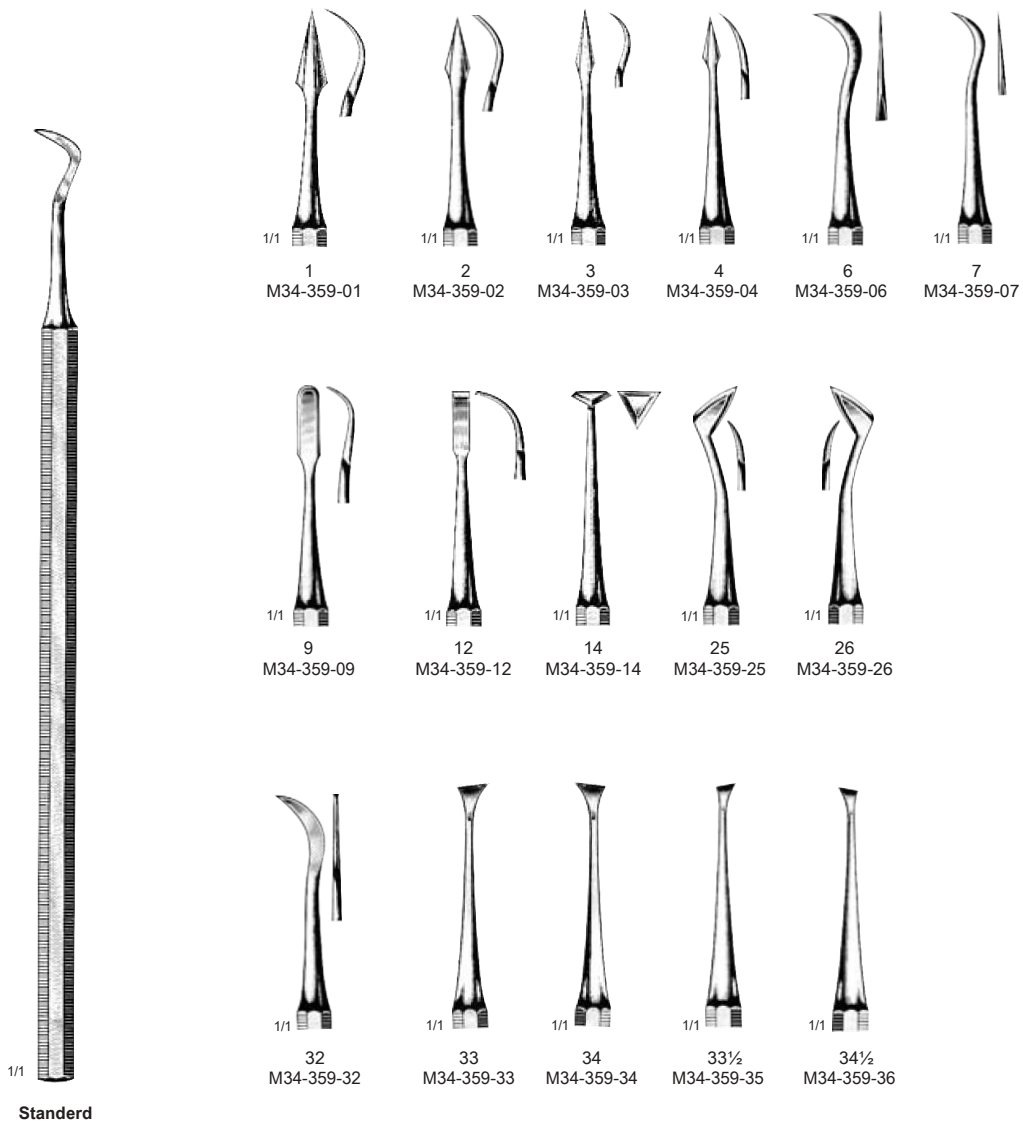

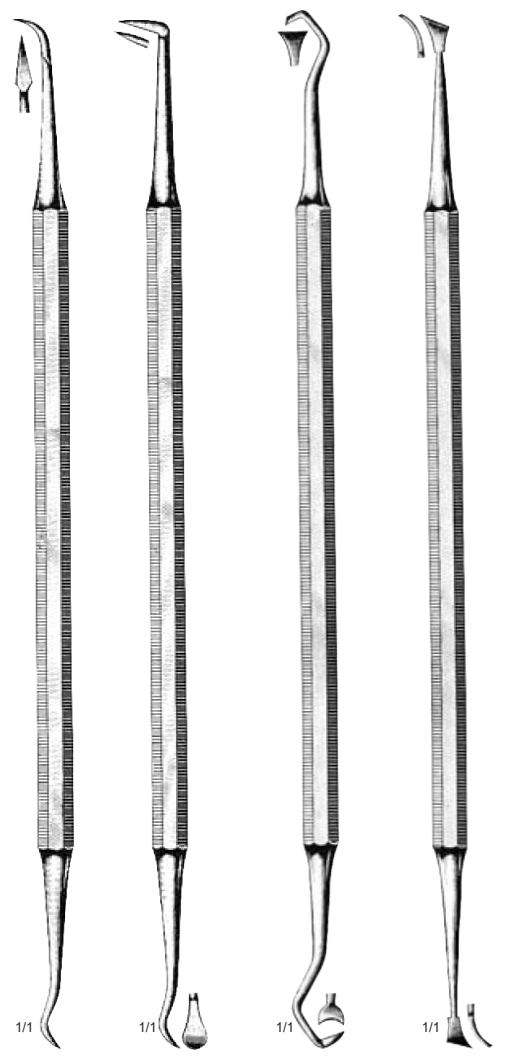

Cumine
 M34-361-02
Mitchell
 M34-363-02
Guenther
 M34-365-02
33/34
 M34-367-02

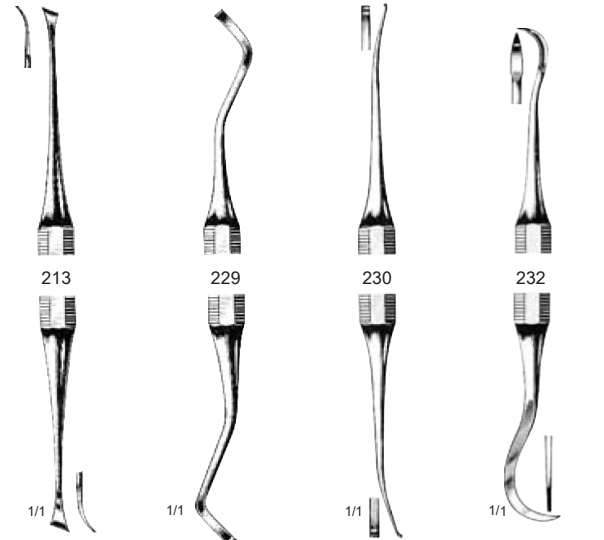

M34-369-13 M34-369-29 M34-369-30 M34-369-32

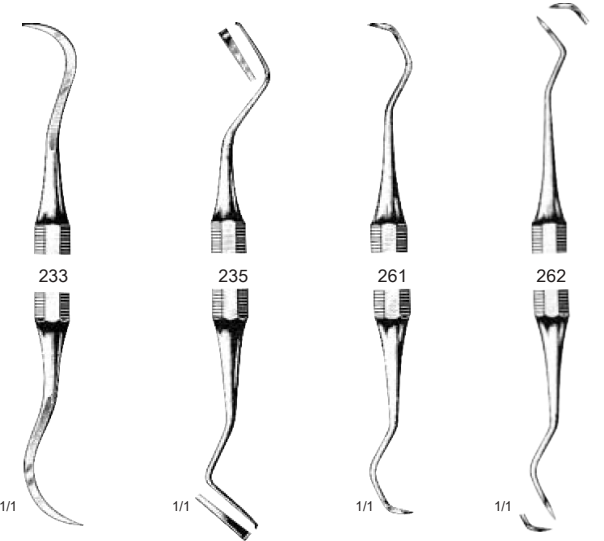

M34-369-33 M34-369-35 M34-369-61 M34-369-62

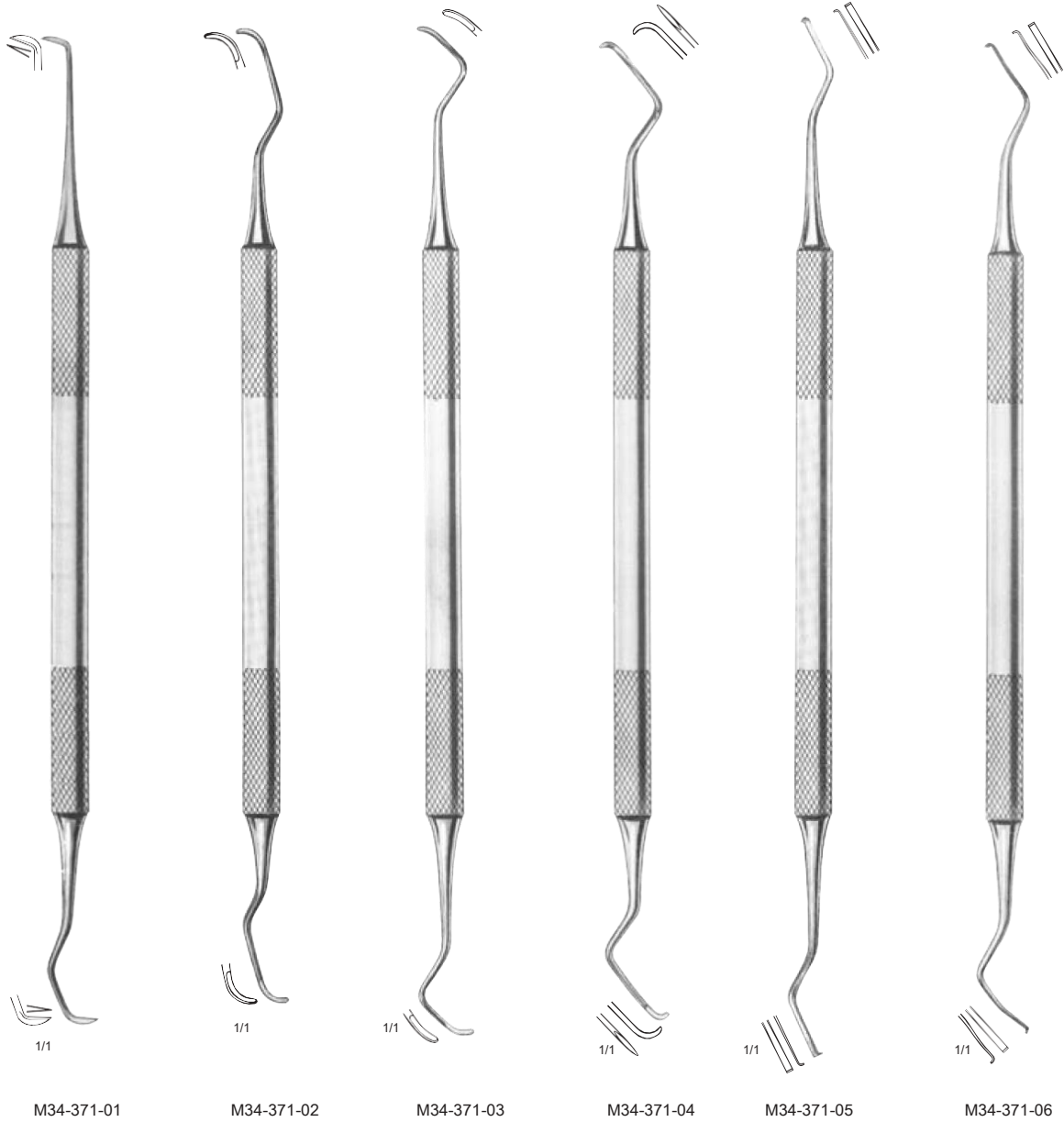

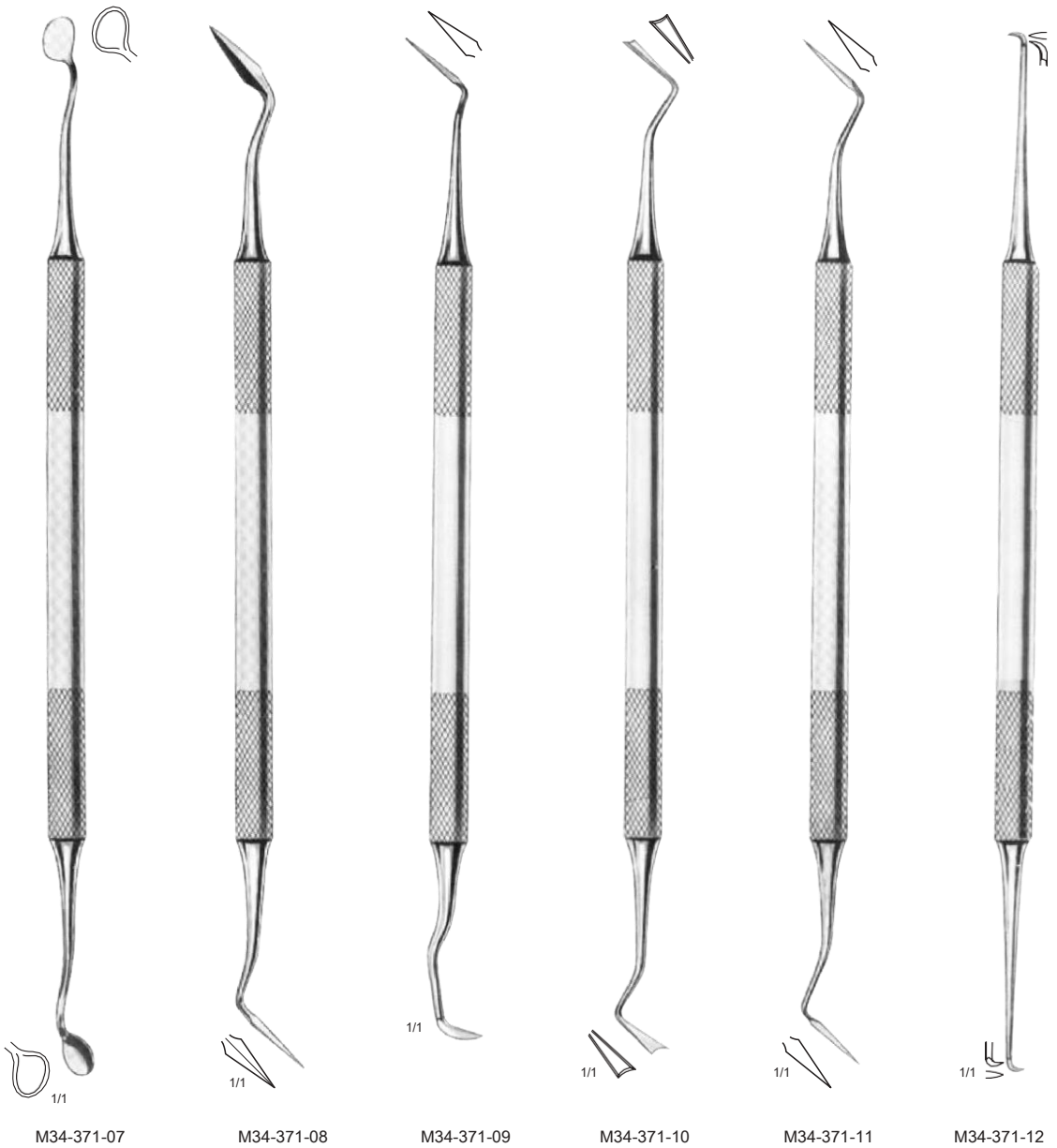

M34-371-07	M34-371-11	Gingivectomy Knives
	M34-371-12	Scaler, double-ended

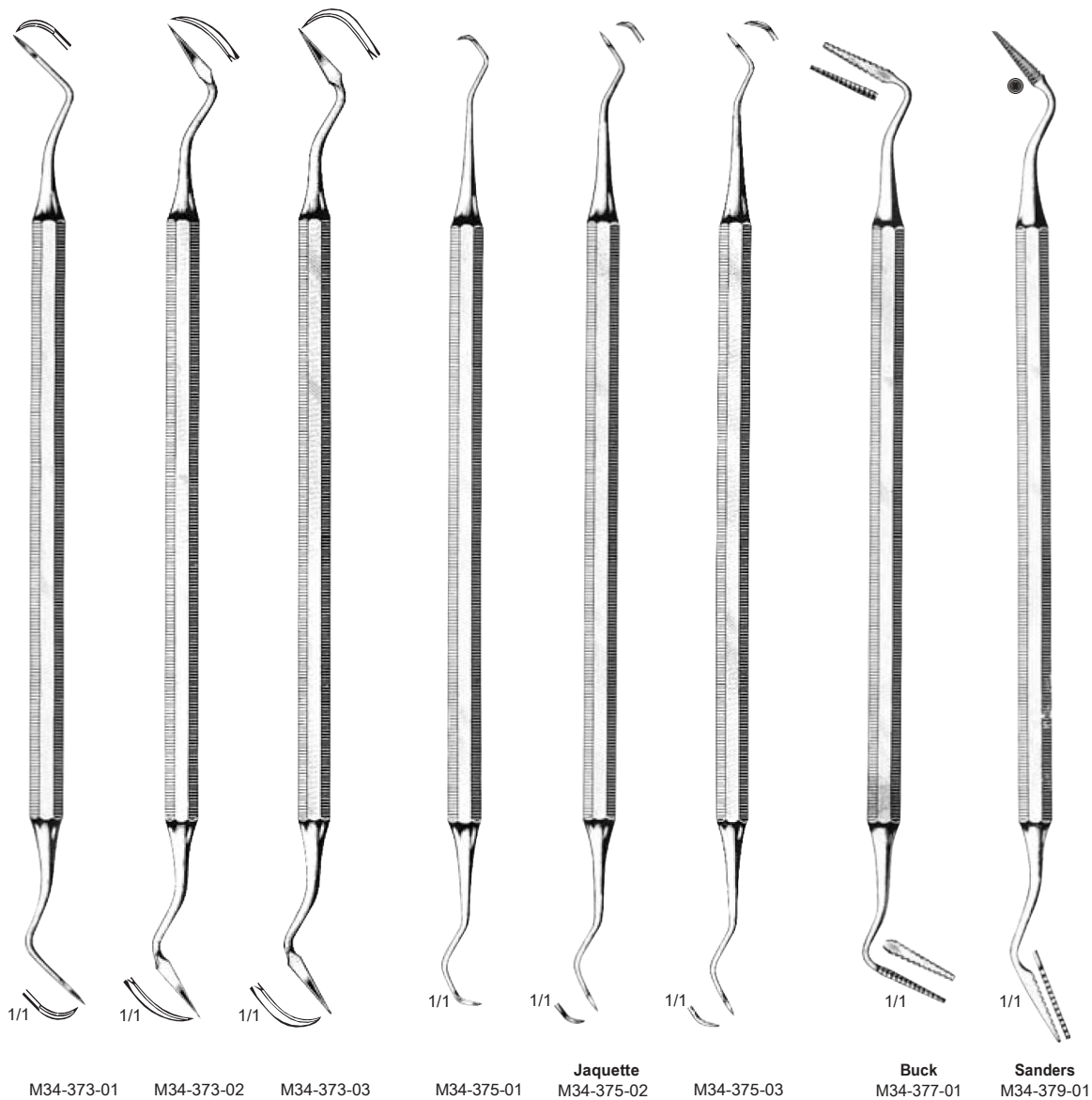

M34-373-01	M34-375-03	Scalers_double-ended
M34-377-01	M34-379-01	Interproximal Trimmers

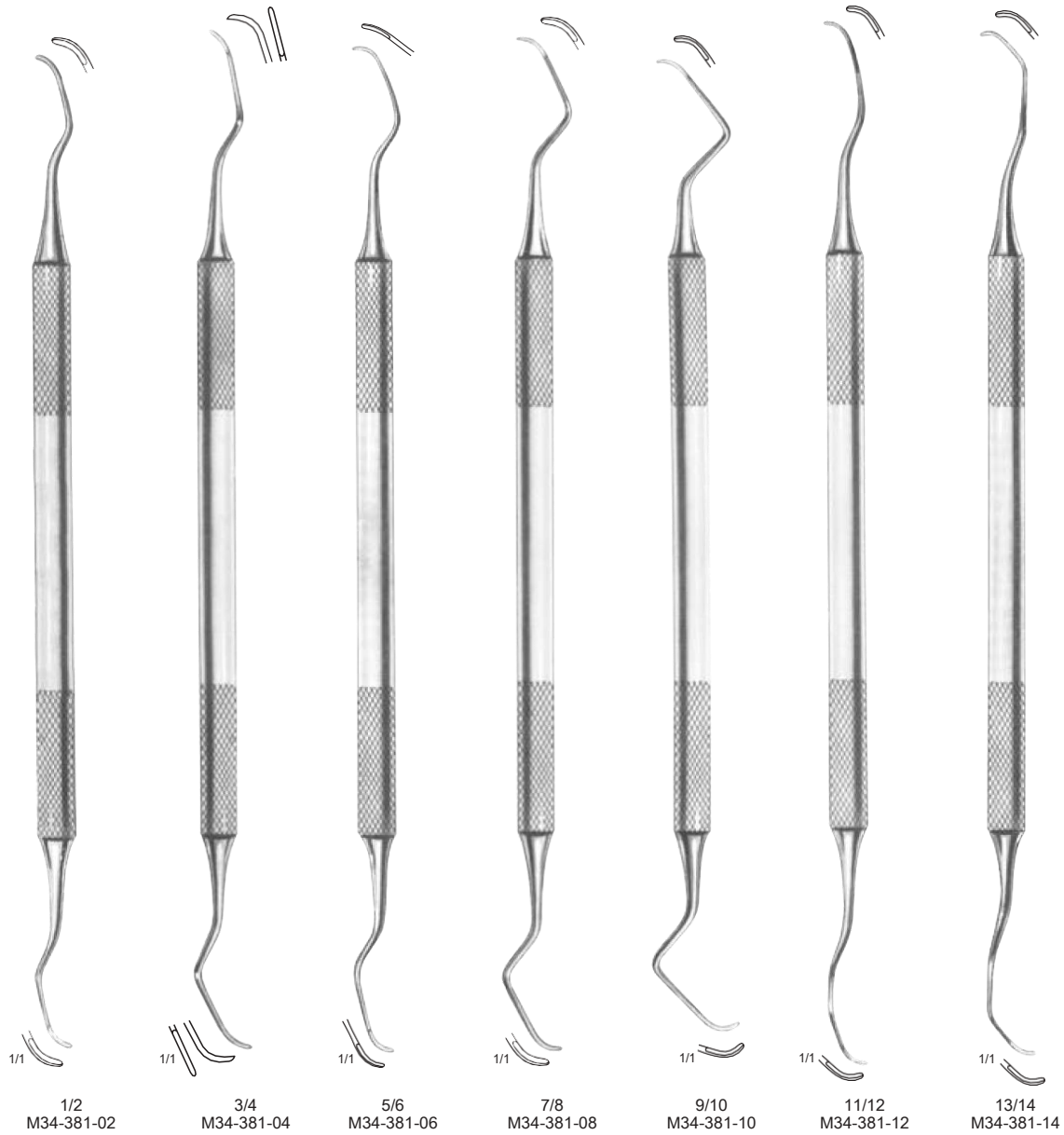

M34-381-02 M34-381-14 Scalers

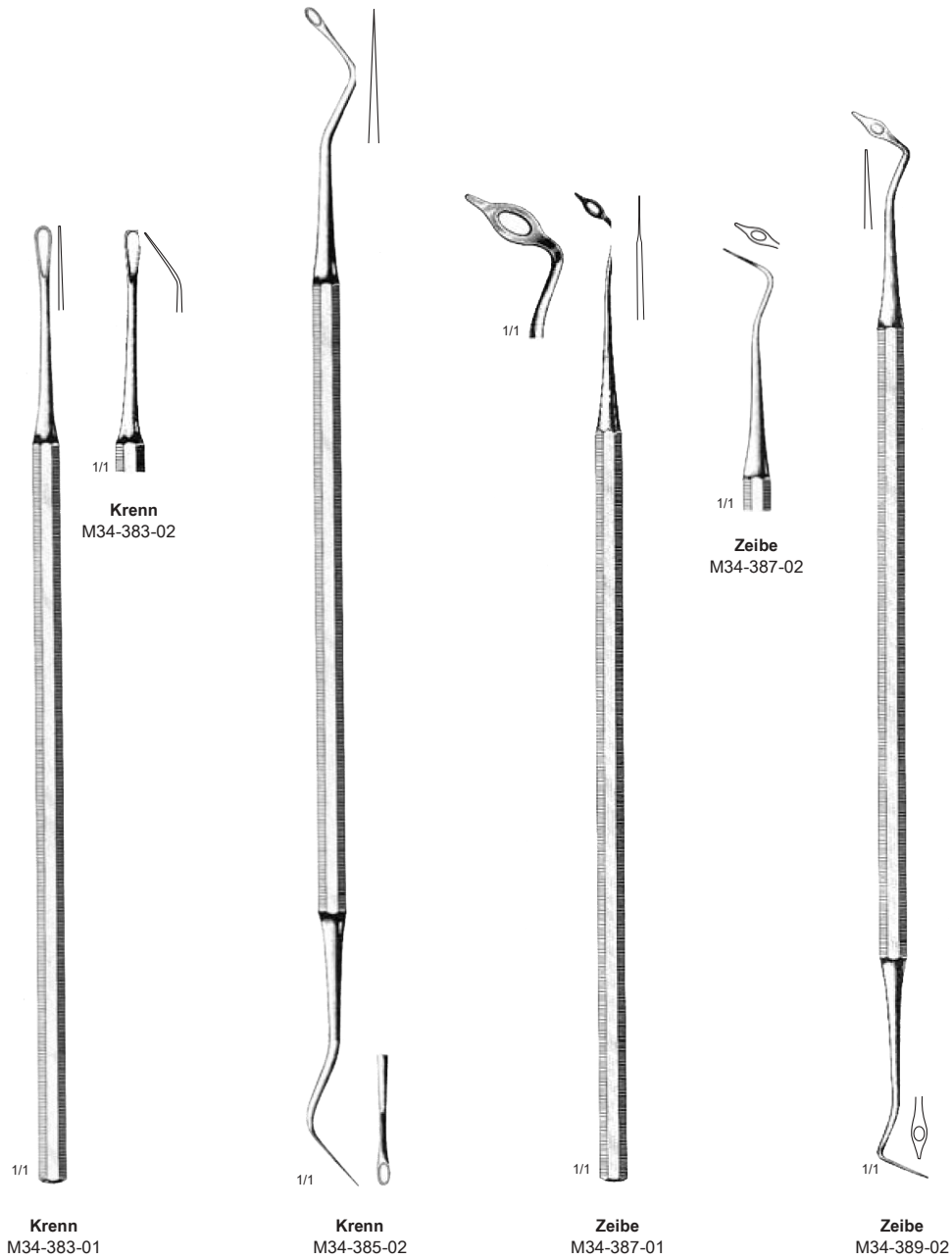

M34-383-01	M34-385-02	Loops
M34-387-01	M34-389-02	Gum Probes with Eye



Crane-Kaplan
M27-173-30

Crane-Kaplan
M27-175-30

M34-393-01

M34-395-01

M34-395-02

Krenn
M34-397-02

M27-173-30	M27-175-30	Pocket markers
M34-393-01	M34-397-02	Probes for measuring gum pockets

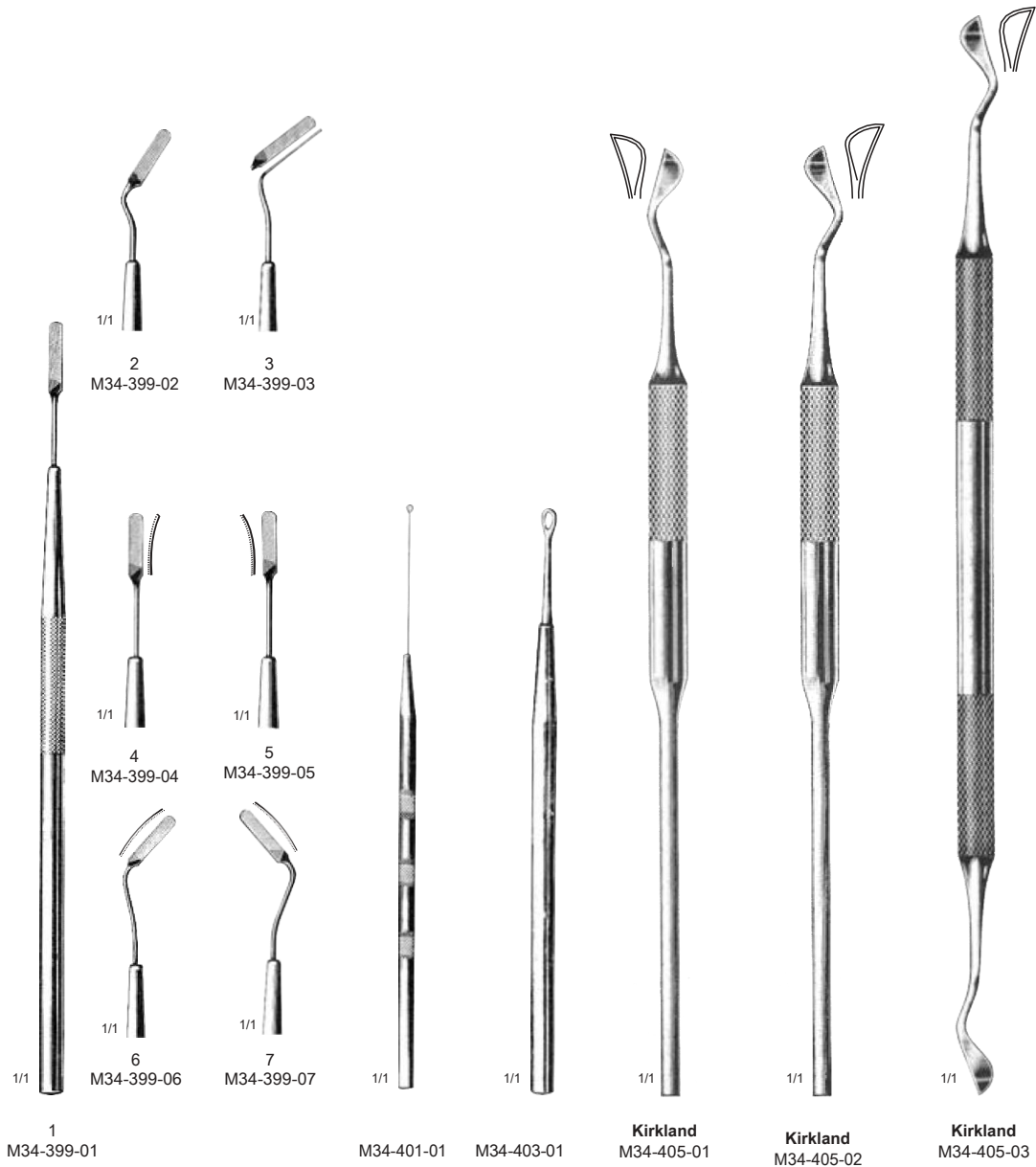

M34-399-01	M34-399-07	Finishing Files
M34-401-01	M34-403-01	Loops
M34-405-01	M34-405-03	Gingivectomy Knives

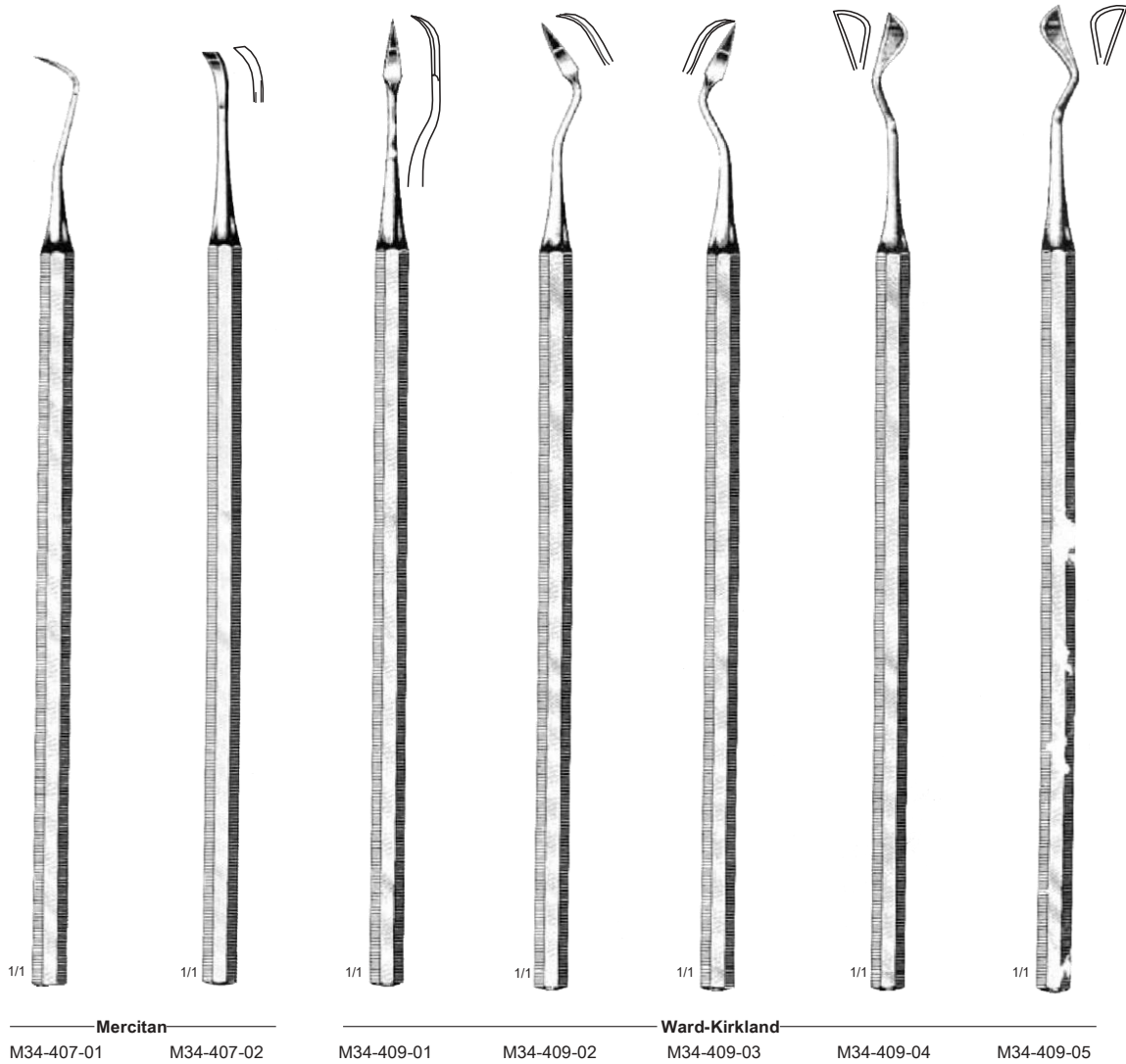

M34-407-01 M34-409-05 Scalers, Single-ended

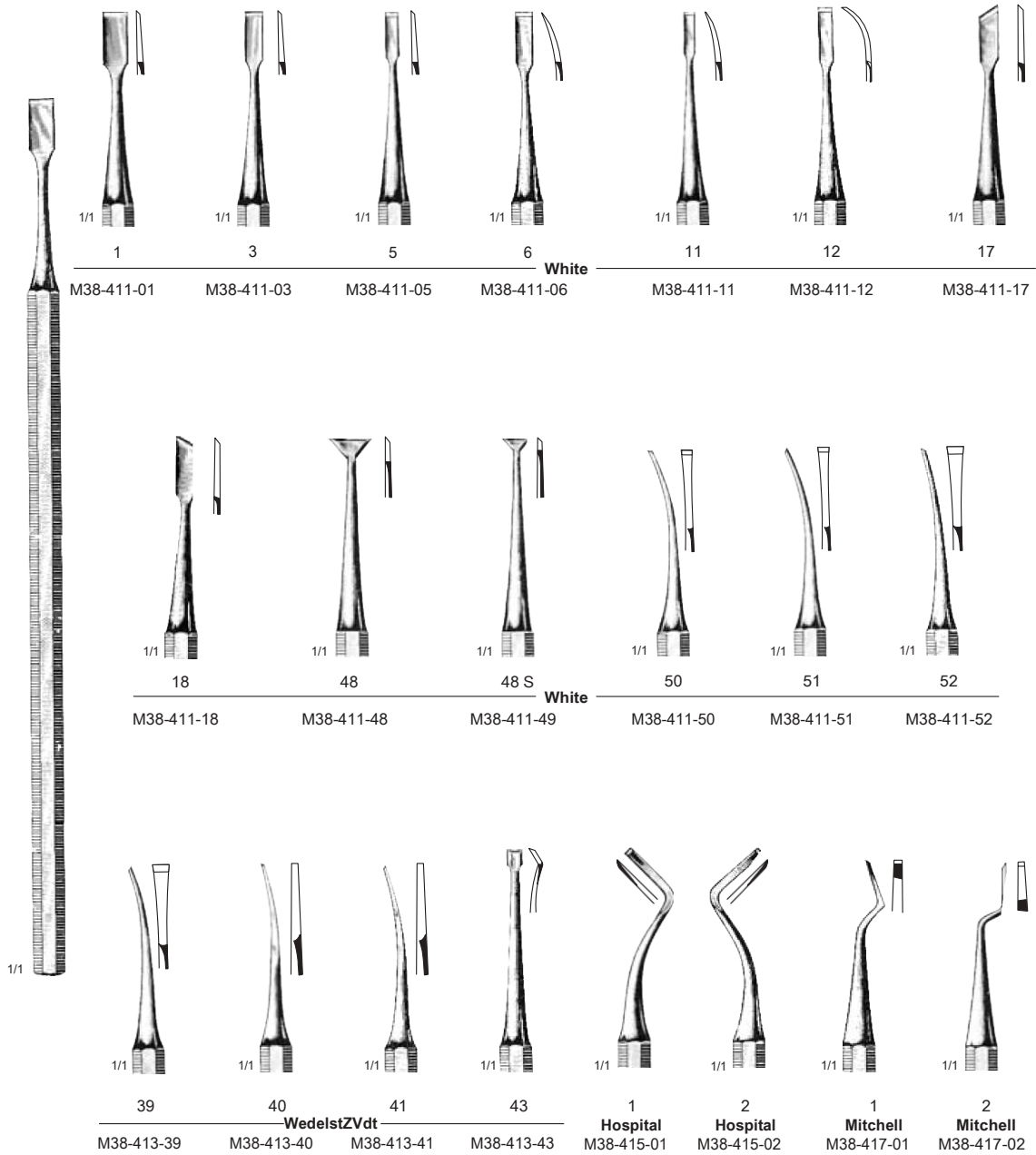

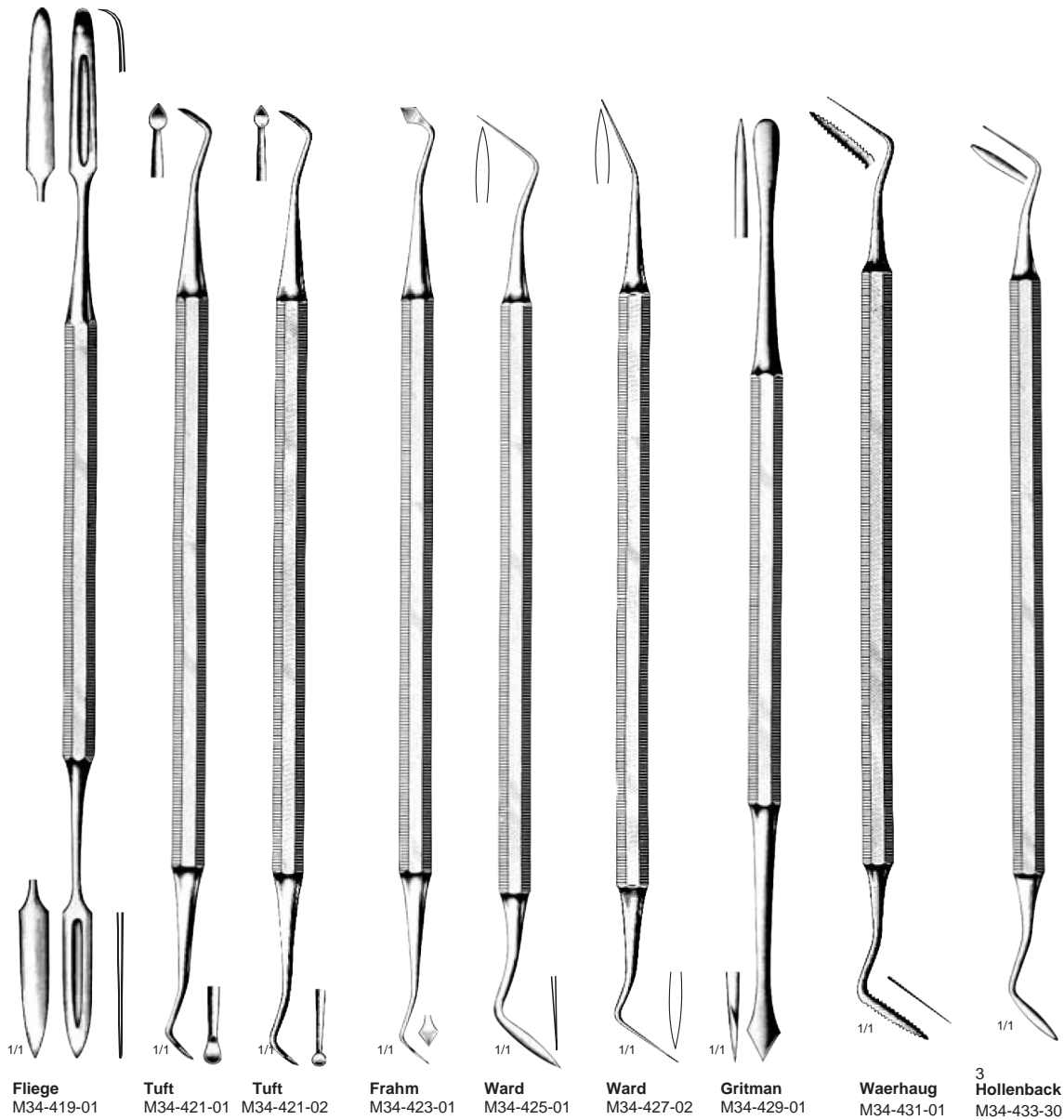

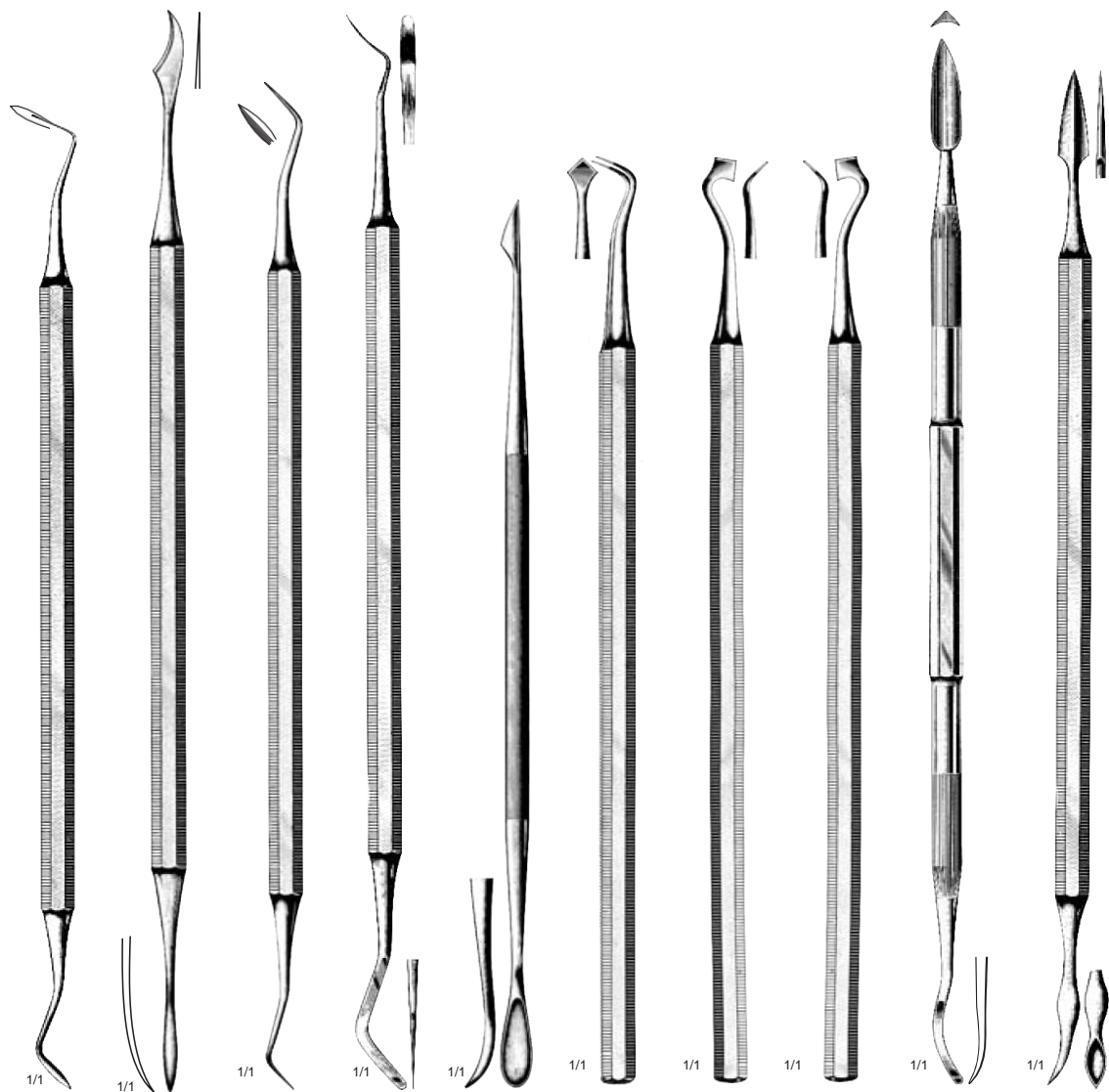

3S
Hollenback
M34-435-31

No. 5
M34-437-01

Shooshan
M34-439-01

M34-441-01

M34-443-01

1
Frahm
M34-445-01

2
Frahm
M34-445-02

3
Frahm
M34-445-03

M34-447-01

Roach
M34-449-01

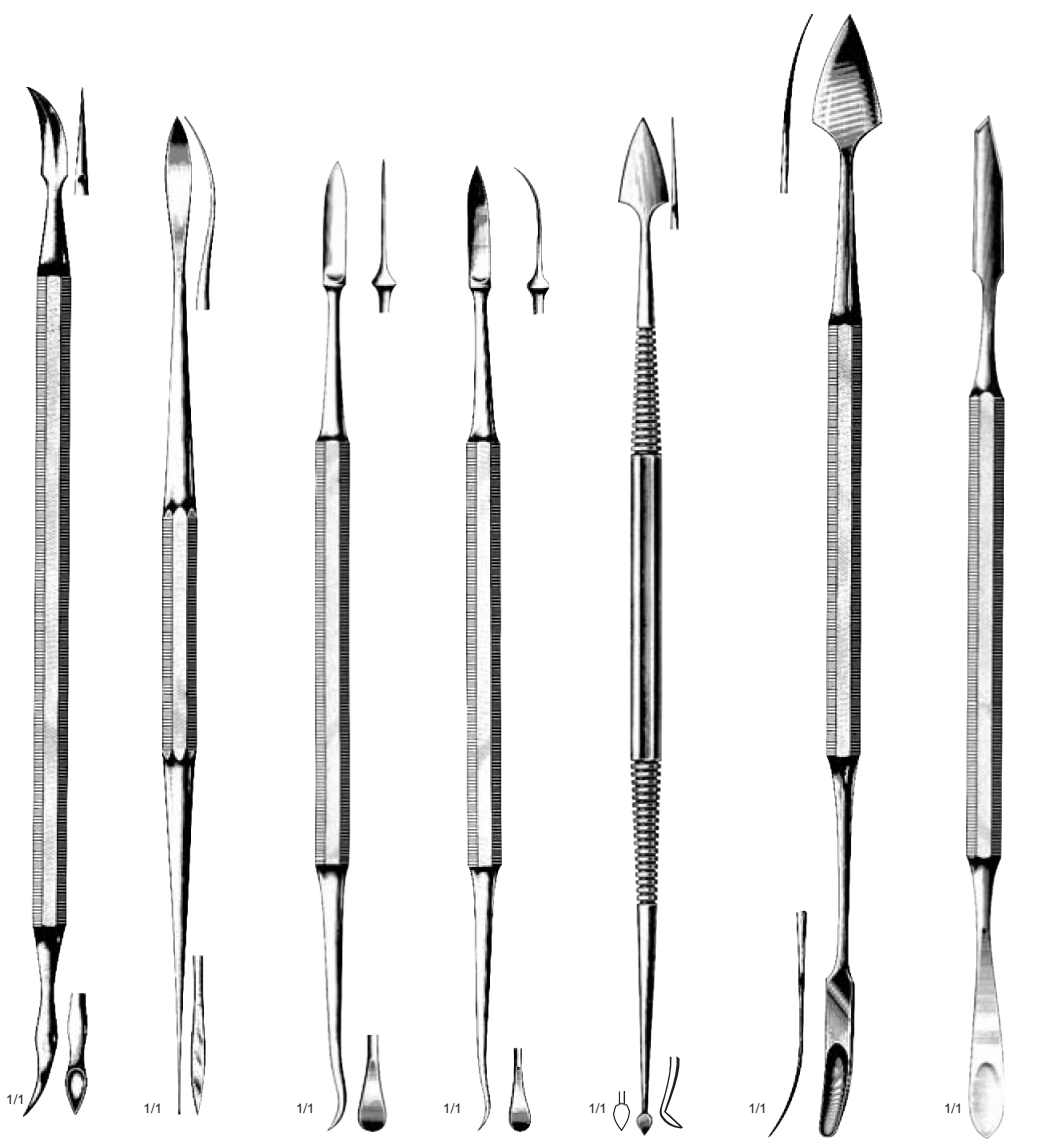

Roach
M34-451-02

Riegner
M34-453-01

Evans
M34-455-01

Evans
M34-457-01

Vehe
M34-459-01

Wolff
M34-461-01

Fjeldstad
M34-463-01

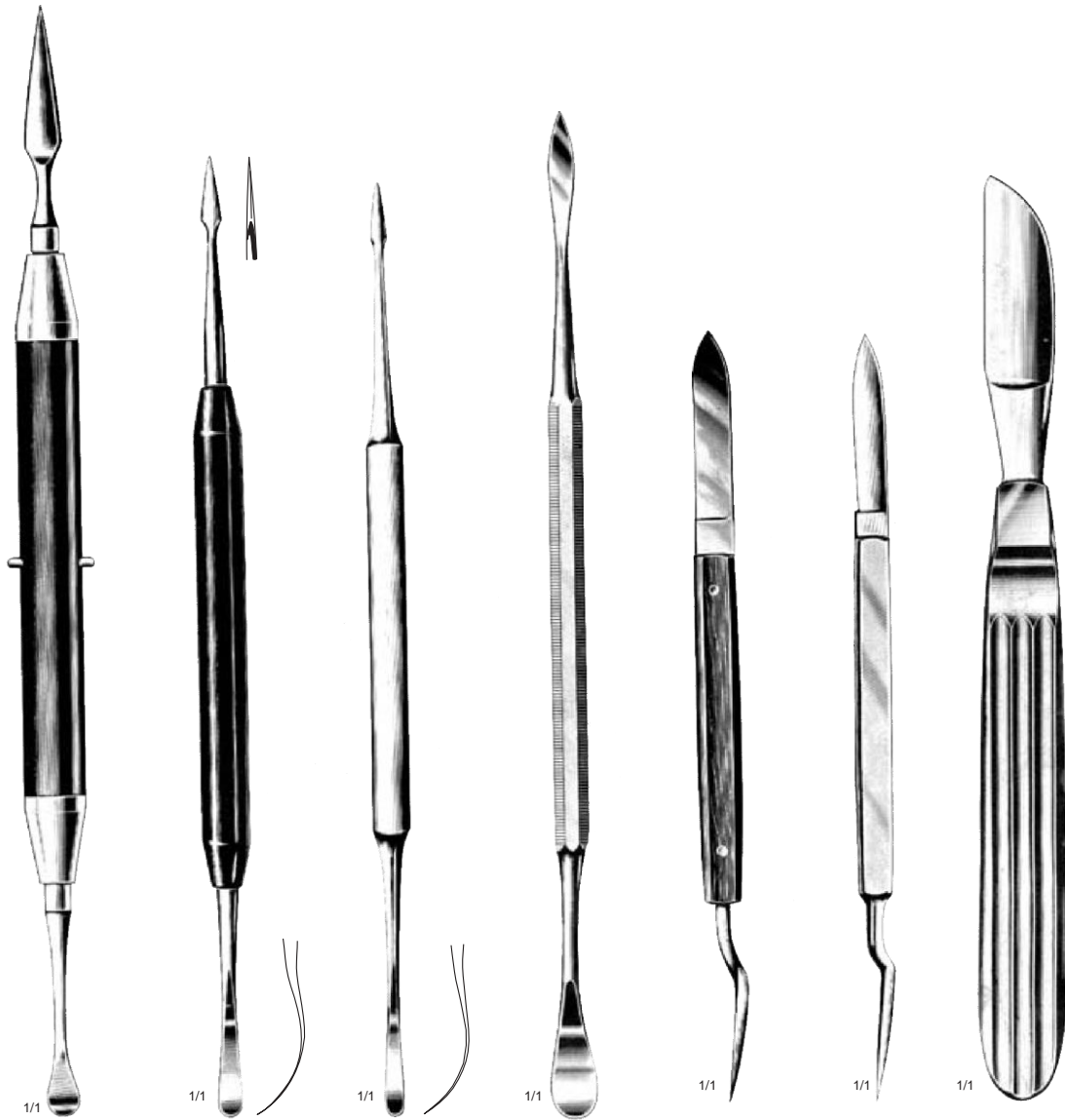

Acker
M34-465-01

Falck
M34-467-01

Falck
M34-469-01

Beale
M34-471-01

Ermert
M34-473-01

Ermert
M34-475-01

Gisy-Wild
15 cm / 6"
M34-477-15

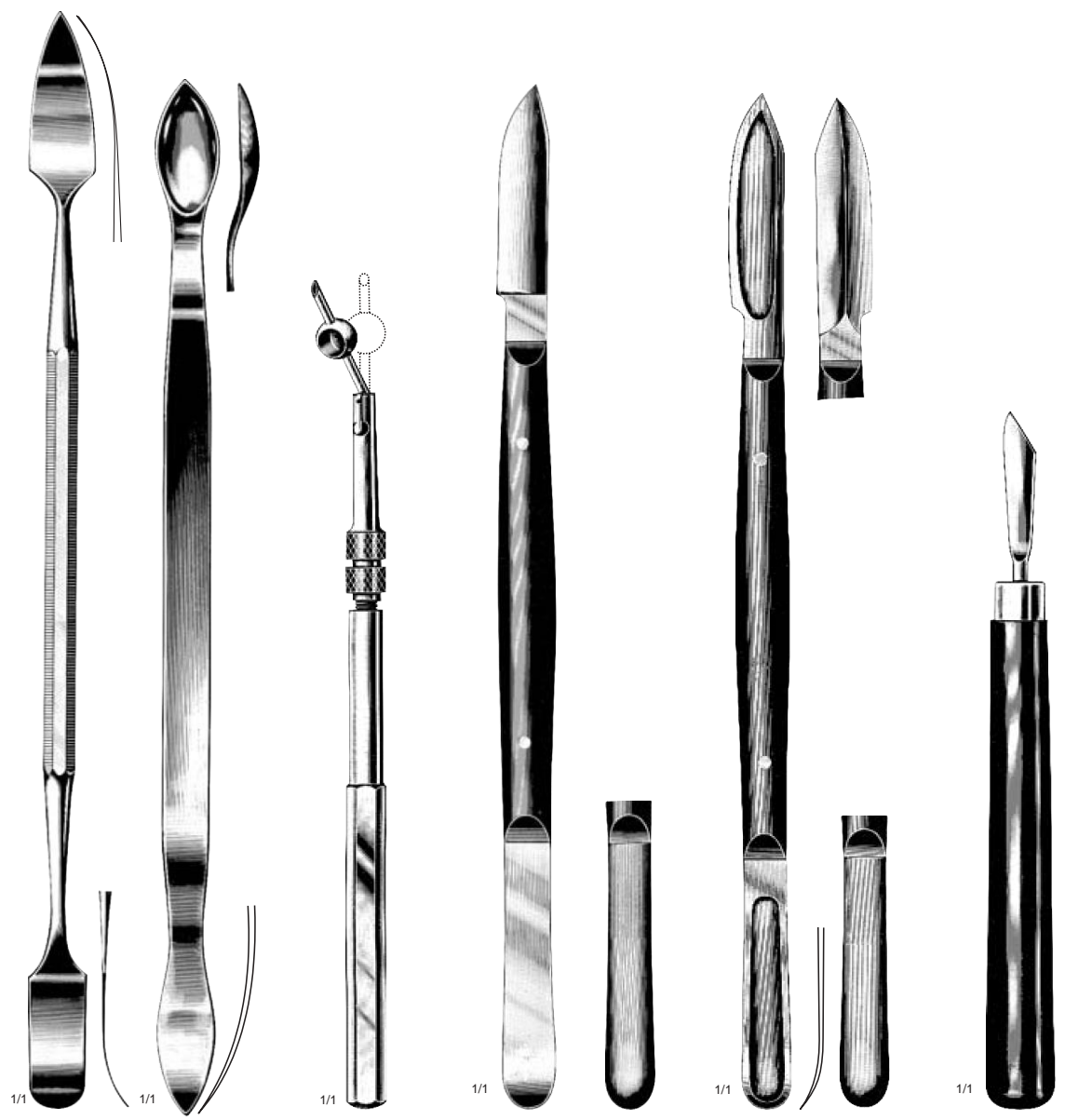

Gritman M34-479-01	Gritman M34-481-01	Cerafix M34-483-01	Fahnenstock 13 cm / 5" M34-485-13	Fahnenstock 17 cm / 6¾" M34-485-17	Lessmann 13 cm / 5" M34-487-13	Lessmann 17 cm / 7" M34-487-17	Antkoviak 12.5 cm / 5" M34-489-12
------------------------------	------------------------------	------------------------------	--	---	---	---	--

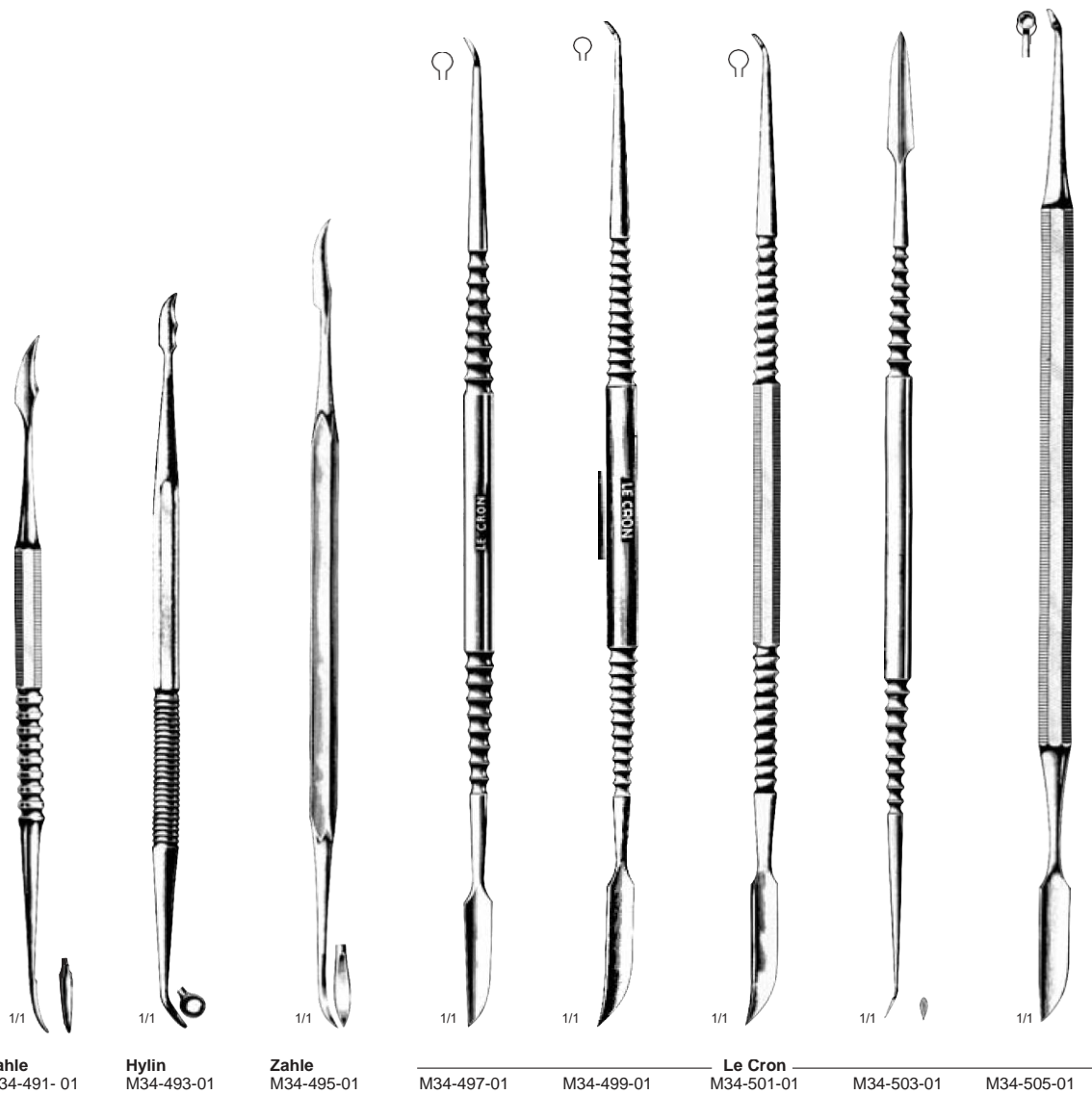

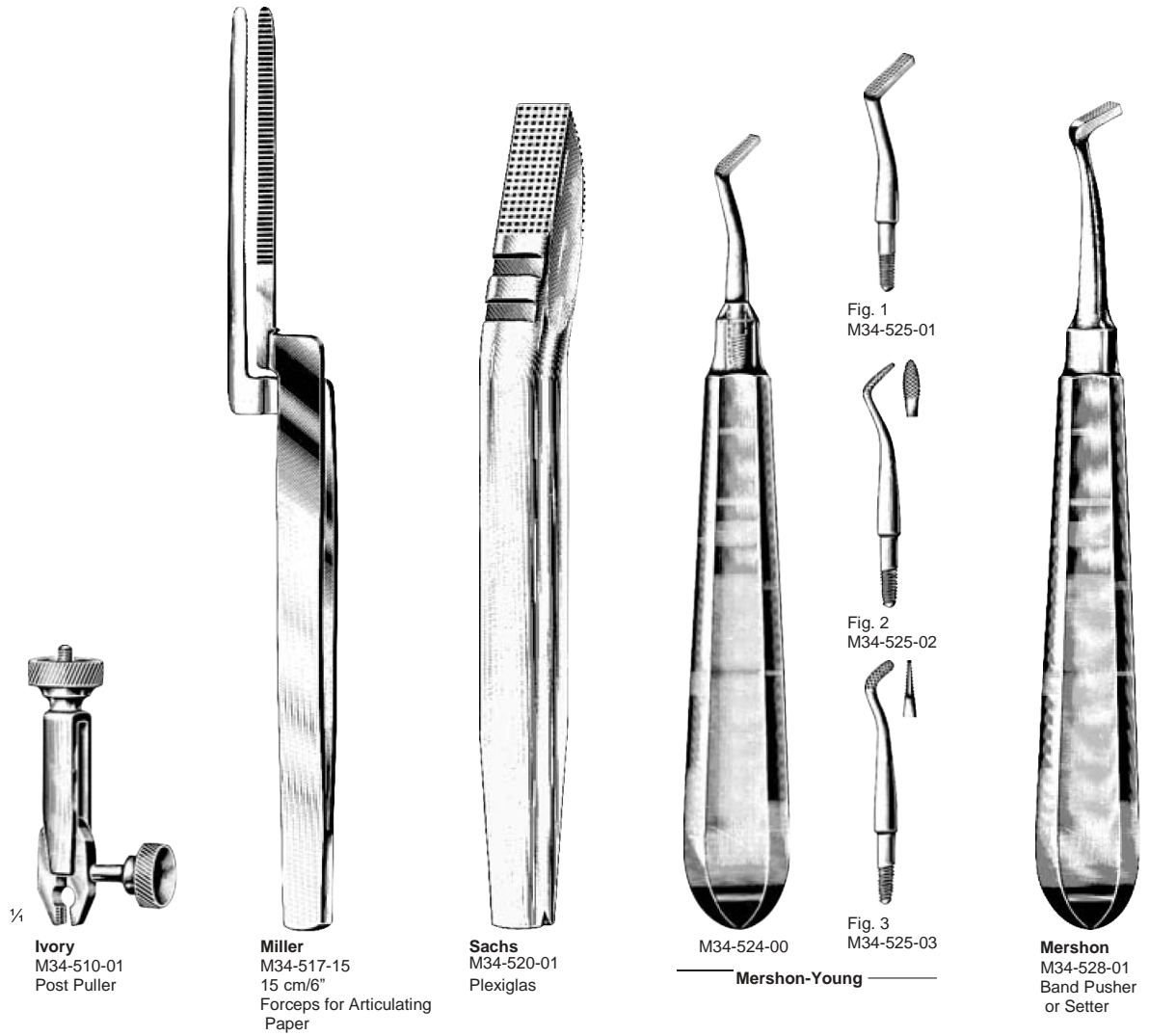

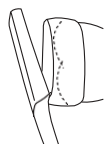

¼

M34-530-01



Steiner
M34-532-01





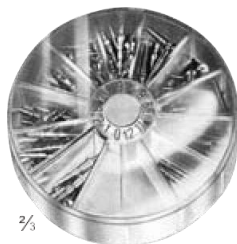









Mod. Paris
M34-5M34-01



⅔

M34-555-00
55 mm Ø 17 mm

Swivel Lid for removing pins easily

	Fig.	
	1	M34-552-01
	2	M34-552-02
	3	M34-552-03
	4	M34-552-04
	5	M34-552-05
	6	M34-552-06
	7	M34-552-07
	8	M34-552-08
	9	M34-552-09
	10	M34-552-10
	14	M34-552-14
	15	M34-552-15

¼



M34-540-01



M34-549-30
10 m/32 ft. 10 in. x 0.3 mm Ø

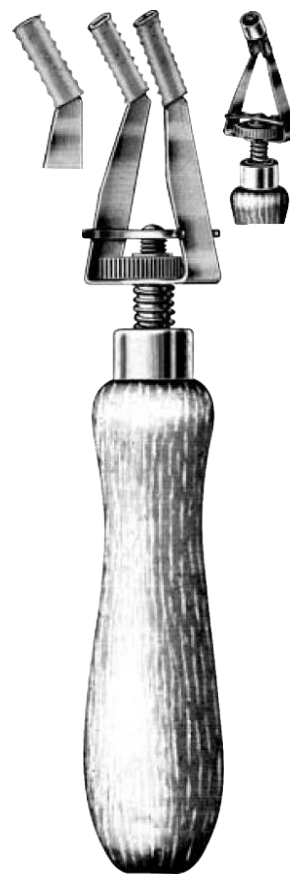

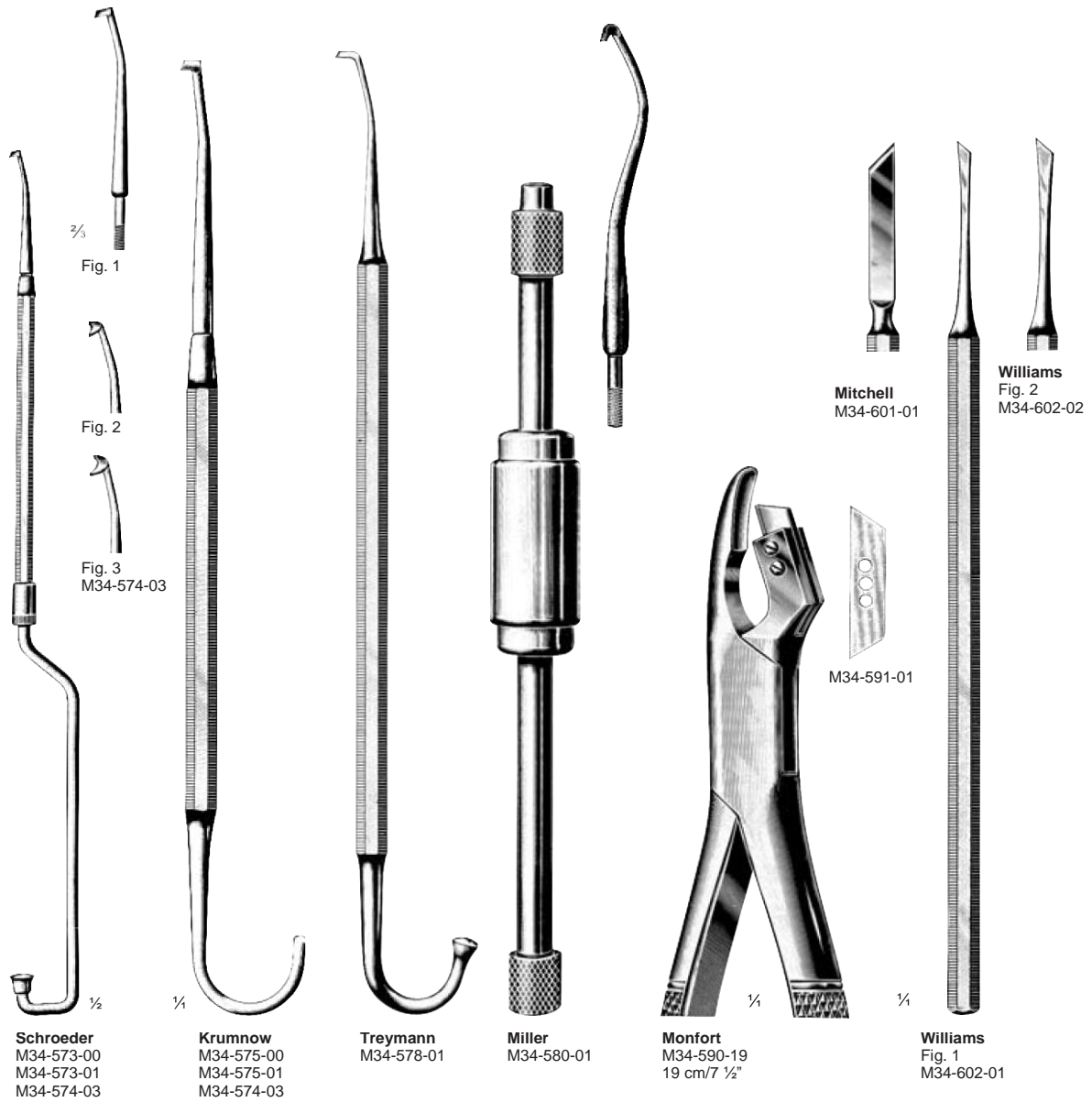



11

MALLETS, BONE ROUNGER & MOUTH GAGS



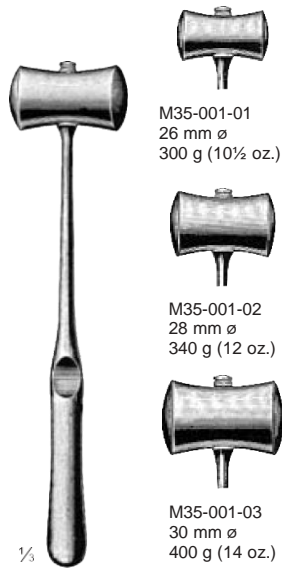

Williger
24 cm / 9½"
lead filled



M35-001-01
26 mm ø
300 g (10½ oz.)



M35-001-02
28 mm ø
340 g (12 oz.)



M35-001-03
30 mm ø
400 g (14 oz.)

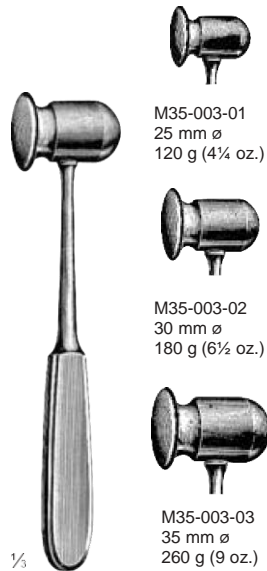

Doyen
21 cm / 8¼"
brass, solid



M35-003-01
25 mm ø
120 g (4¼ oz.)



M35-003-02
30 mm ø
180 g (6½ oz.)



M35-003-03
35 mm ø
260 g (9 oz.)



Collin
M35-005-20
20 cm / 8"
brass, solid

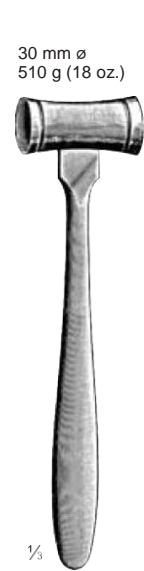

M35-007-22
22.5 cm / 9"
steel, solid

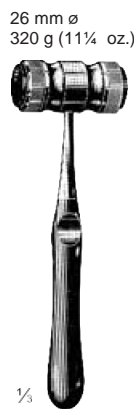

Mead
M35-009-17
17 cm / 6¾"
solid
M35-009-00
Ferrozell Cheeks
only, pair

with interchangeable
Ferrozell Cheeks



M35-011-01
lead filled
M35-011-02
brass, solid
16.5 cm / 6½"

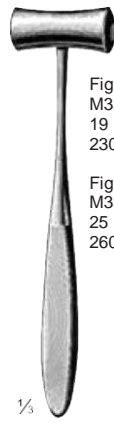

Lucae
19 cm / 7½"
brass, solid

Fig. 1
M35-013-01
19 mm ø
230 g (8 oz.)

Fig. 2
M35-013-02
25 mm ø
260 g (9 oz.)

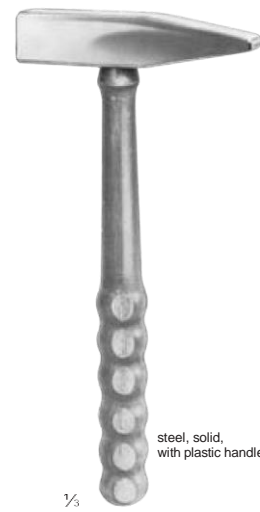

M35-015-24
24 cm / 9½"
steel, solid,
with plastic handle

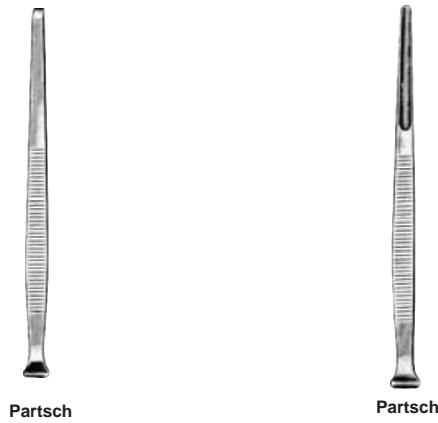
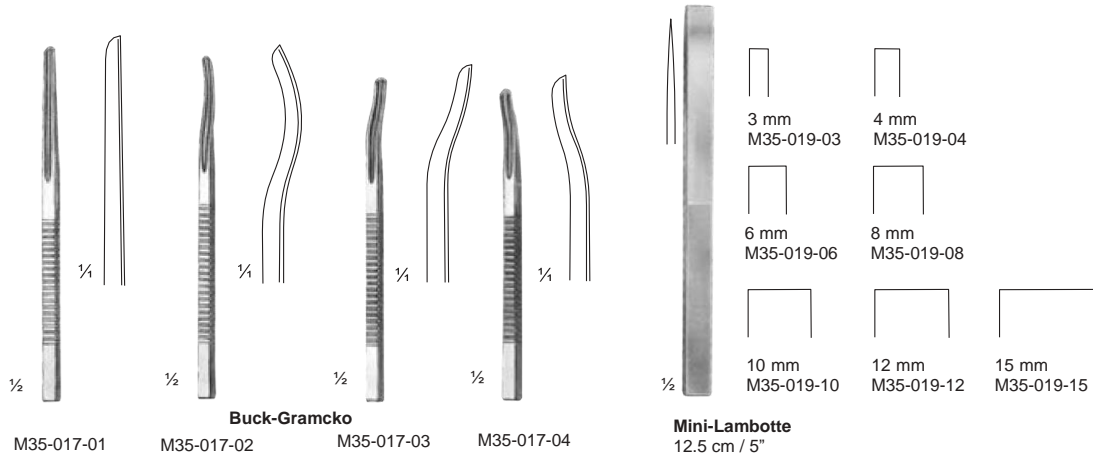

11.5 cm/4½"	13.5 cm/5¼"	width mm	11.5 cm/4½"	13.5 cm/5¼"
M35-021-02	M35-023-02	2	M35-025-02	M35-027-02
M35-021-03	M35-023-03	3	M35-025-03	M35-027-03
M35-021-04	M35-023-04	4	M35-025-04	M35-027-04
M35-021-05	M35-023-05	5	M35-025-05	M35-027-05
M35-021-06	M35-023-06	6	M35-025-06	M35-027-06
M35-021-07	M35-023-07	7	M35-025-07	M35-027-07
M35-021-08	M35-023-08	8	M35-025-08	M35-027-08

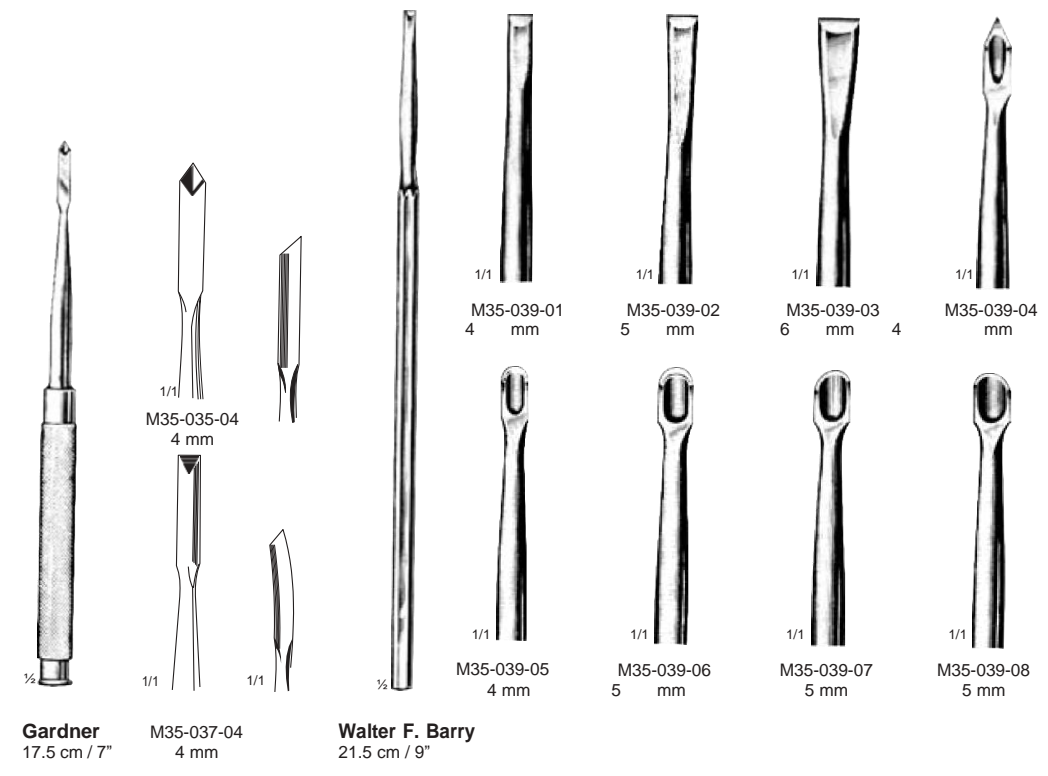
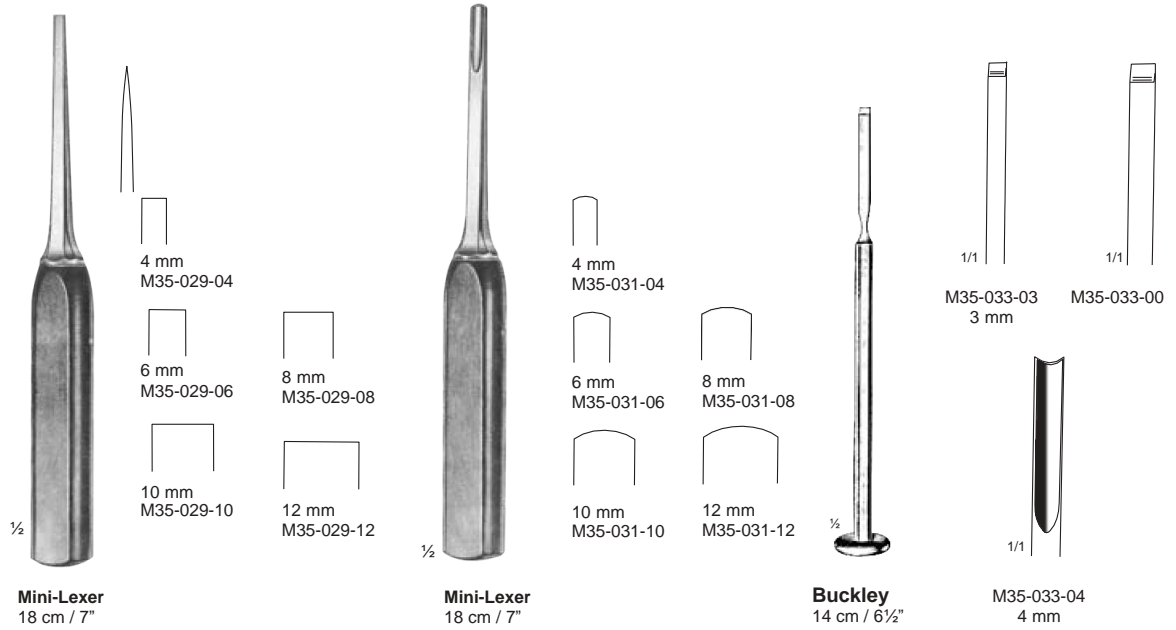

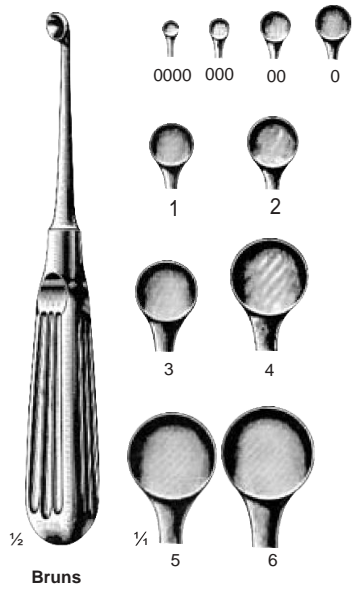

Bruns

- M35-041-40
- M35-041-30
- M35-041-20
- M35-041-10
- M35-043-01
- M35-043-02
- M35-043-03
- M35-043-04
- M35-043-05
- M35-043-06

- Fig.
- 0000
 - 000
 - 00
 - 0
 - 1
 - 2
 - 3
 - 4
 - 6

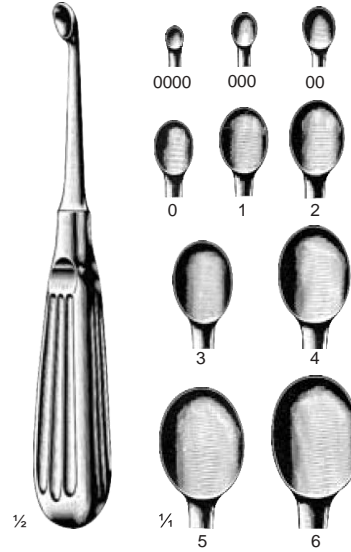
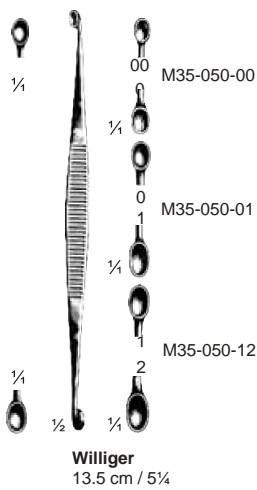
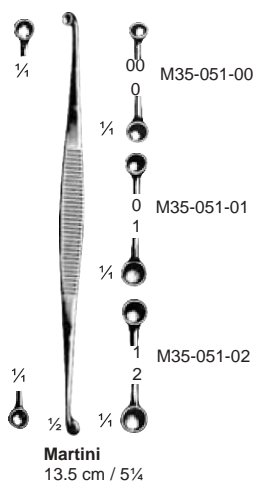

Fig. **Volkmann**

- 0000 M35-045-40
- 000 M35-045-30
- 00 M35-045-20
- 0 M35-047-10
- 1 M35-047-01
- 2 M35-047-02
- 3 M35-049-03
- 4 M35-049-04
- 5 M35-049-05
- 6 M35-049-06



Williger
13.5 cm / 5 1/4"



Martini
13.5 cm / 5 1/4"

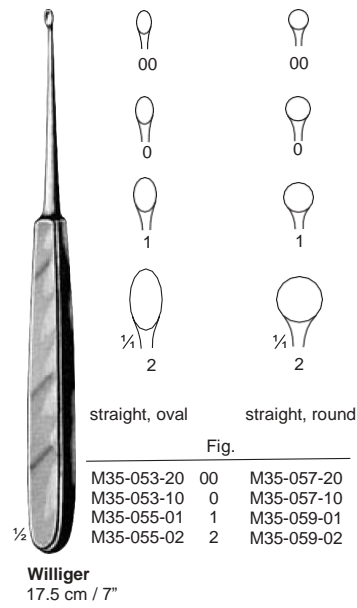

Williger
17.5 cm / 7"

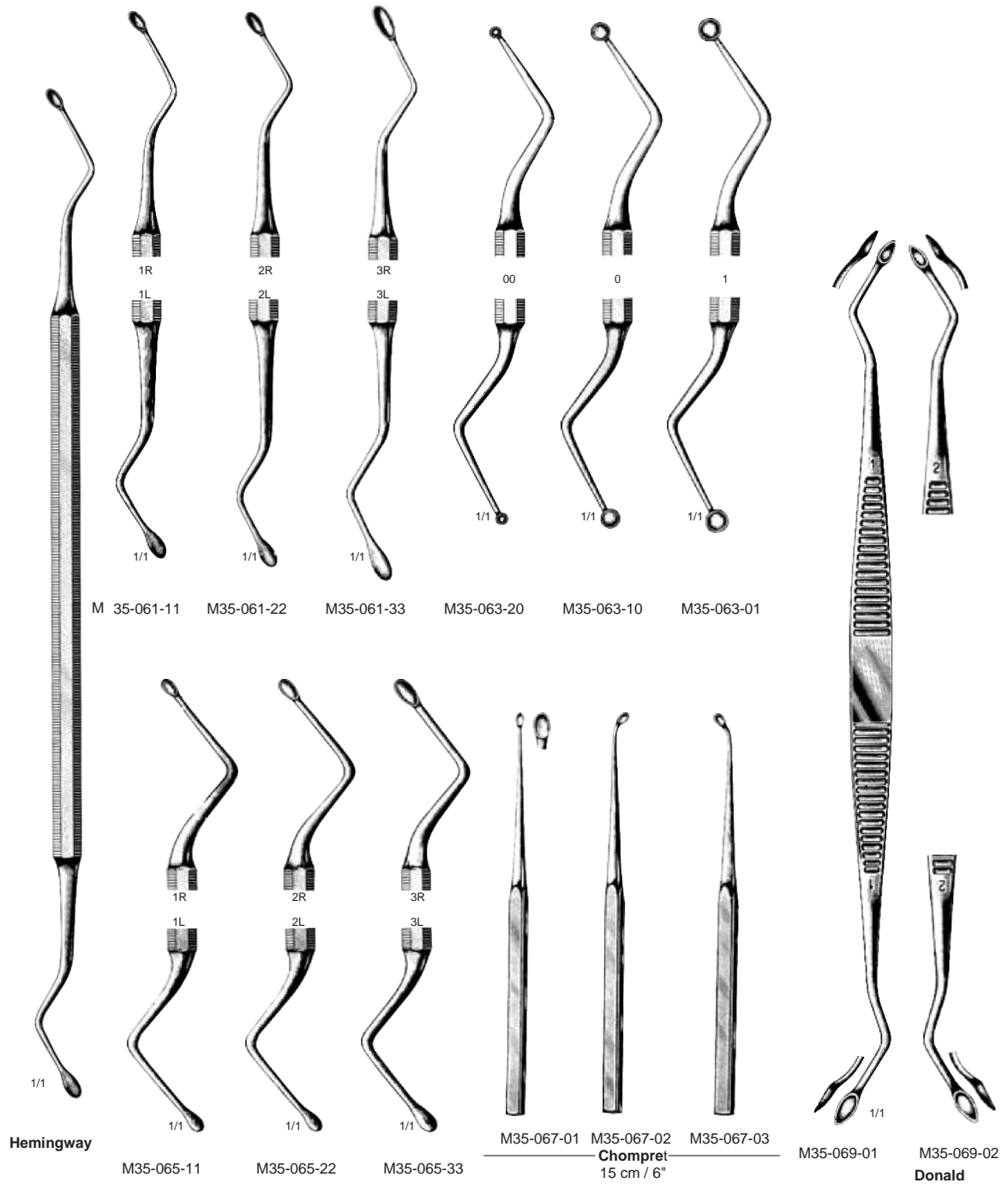



Miller-Colburn

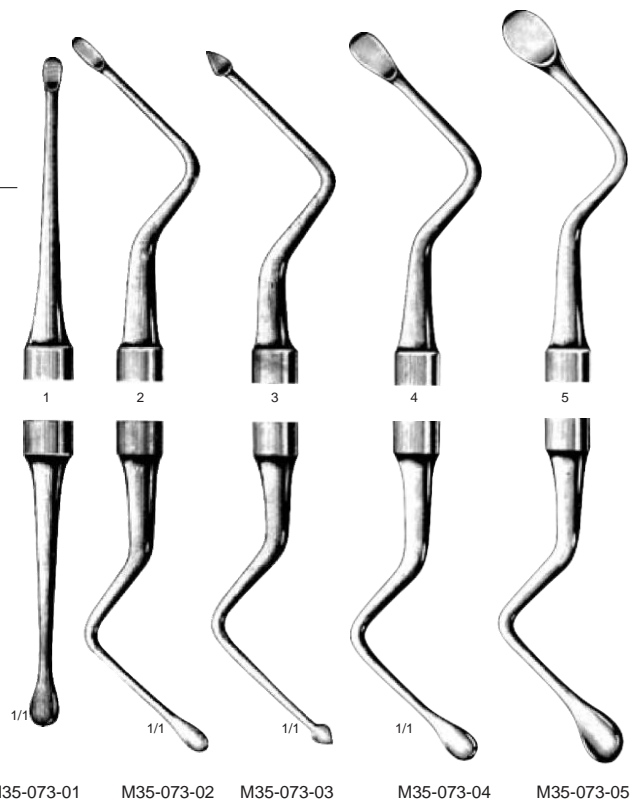

Mead

Alveolotomy Files, Periosteal Elevators



M35-075-11 M35-075-22 M35-075-33 M35-075-44 M35-077-12 M35-077-34 M35-079-01 M35-081-01

Lucas



M35-083-01 M35-083-02 M35-083-03 M35-083-04 M35-083-05

Miller-Colburn

Williger
17 cm / 6 3/4"
M35-085-17

Williger
16 cm / 6 1/4"
M35-087-16

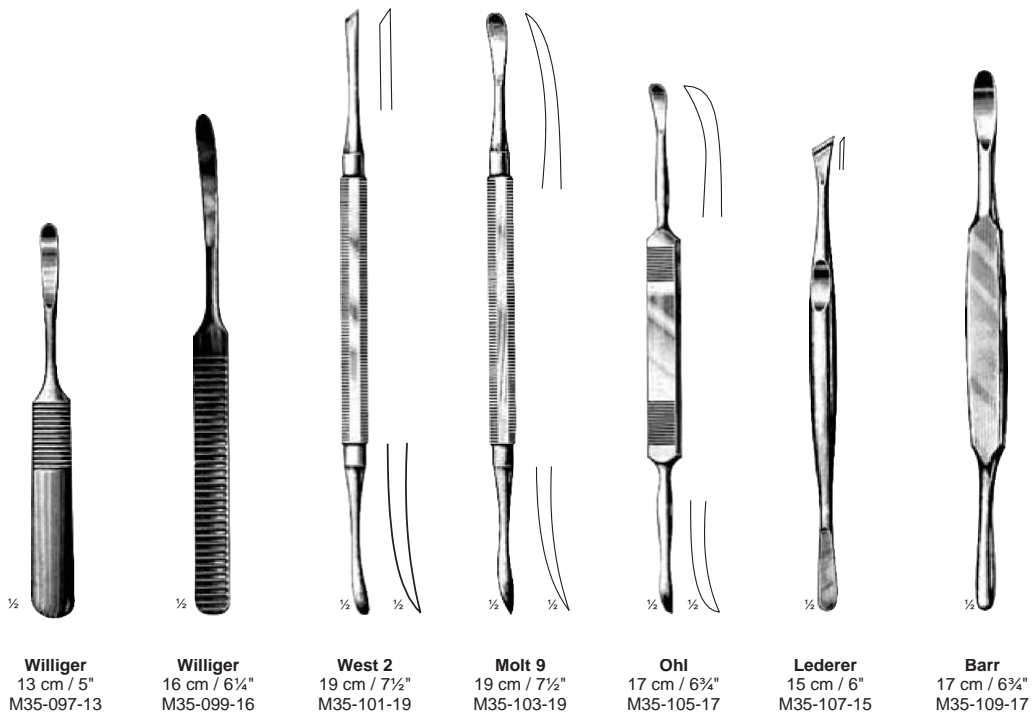



Frazier
13 cm / 5"
M35-111-13



Kilner
M35-113-15
15 cm/6"



Gillies
M35-115-18
18 cm/7"



Knapp-Rollet
13 cm / 5"
M35-117-02 (2 Teeth)
M35-117-03 (3 Teeth)
M35-117-04 (4 Teeth)



Barth
18 cm / 7"
M35-119-18



Schwartz
11 cm / 4 1/2"

Chisels	Width mm	Gouges
M35-121-03	3	M35-123-03
M35-121-04	4	M35-123-04
M35-121-05	5	M35-123-05
M35-121-06	6	M35-123-06
M35-121-08	8	M35-123-08
M35-121-10	10	M35-123-10



Schwartz
11 cm / 4 1/2"



Fischer
15 cm / 5"

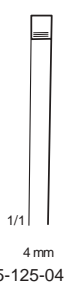

1/1
4 mm
M35-125-04



1/1
5 mm
M35-125-05



1/1
4 mm
M35-125-04



1/1
5 mm
M35-125-05



1/1
9 mm
M35-125-09

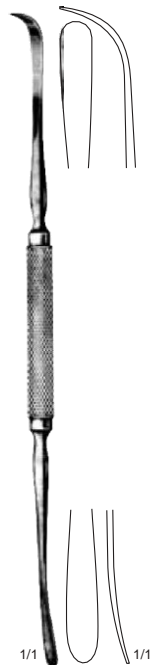

Freer
20 cm / 8"
M35-129-20



Freer
16 cm / 6 1/4"
M35-131-16
4 mm



Killian
16 cm / 6 1/4"
M35-133-16

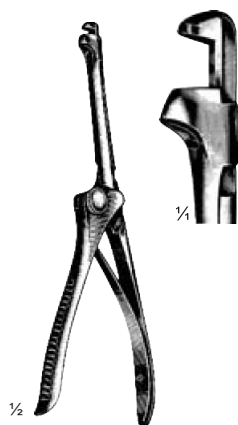

Hajeki-Calus
M35-135-20 mm



Kerrison
M35-137-17 M35-
137-05 mm M35-
137-06 mm M35-
137-07 mm

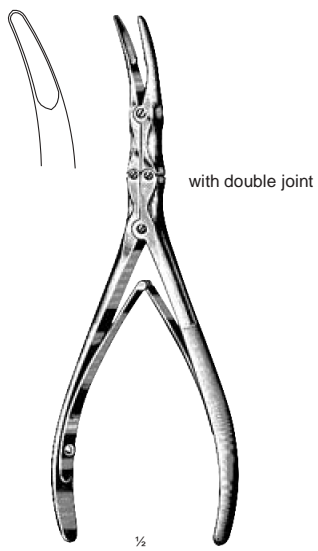

Beyer
18 cm / 7"
M35-139-18



Cleveland
17 cm / 6 3/4"
M35-141-17

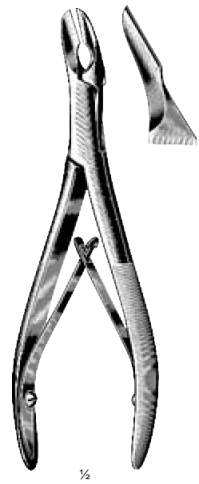

Cleveland
15 cm / 6"
M35-143-15

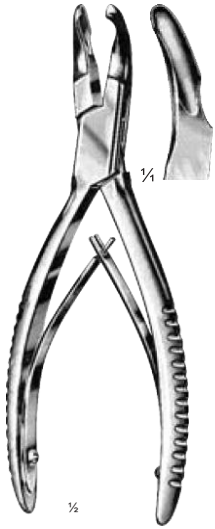

Cleveland
M35-145-17
17 cm / 6 3/4"

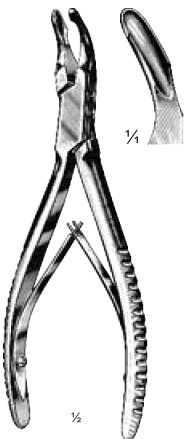

Cleveland
M35-147-14
14 cm / 5 1/2"



Friedman
M35-149-14
14 cm / 5 1/2"



Friedman-Mini
M35-151-12
12 cm / 4 3/4"



15 cm / 6"
M35-153-15



Cleveland-Gardener
16 cm / 6 1/4"
M35-155-16



Cleveland-Gardener
16 cm / 6 1/4"
M35-157-16

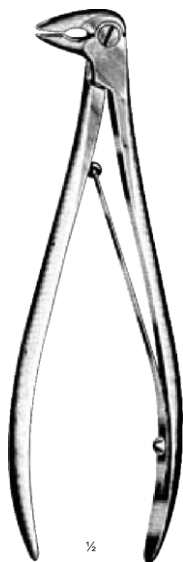

18 cm / 7"
M35-159-18



Luer
M35-161-15
15 cm / 6"



Luer
M35-163-15
15 cm / 6"

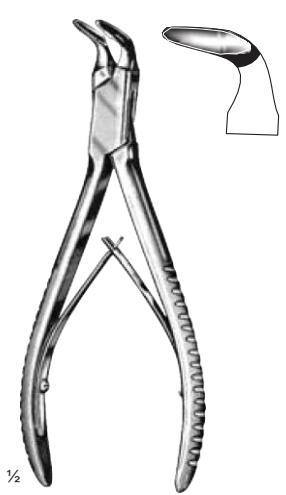

Blumenthal
15.5 cm/6"
M35-165-15



Blumenthal
15.5 cm/6"
M35-167-15



Blumenthal
15.5 cm/6"
M35-169-15



Hartmann
18.5 cm / 7 1/4"
M35-171-18

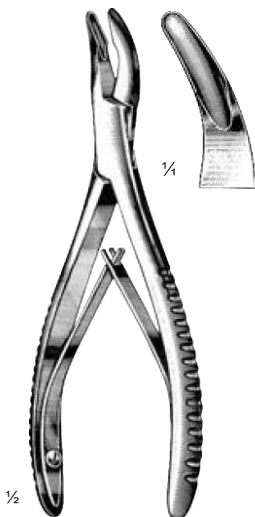

Mead
16.5 cm/6 1/2"
M35-173-16

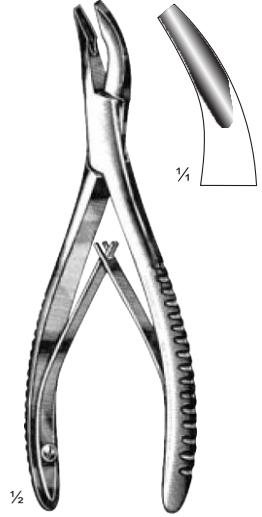

Mead
16.5 cm/6 1/2"
M35-175-16



Heister
13 cm/5"
M35-177-13



Doyen-Jansen (Molt)
12 cm/4 ¾"
M35-179-12
Child



Doyen-Jansen (Molt)
14 cm/5 ½"
M35-181-14
Adult

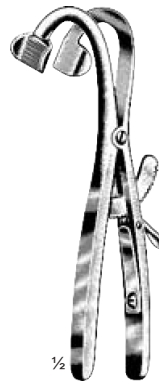

Denhart
12 cm/4 ¾"
M35-183-12

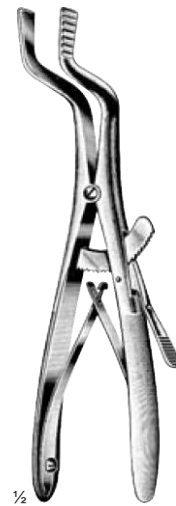

Rosier-Koeing
cm in
16 6 ¼ M35-185-16
19 7 ½ M35-185-19

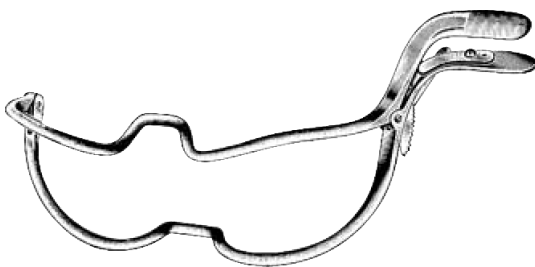

Jenning
cm in
09 3 ½ M35-189-09
11 4 ¼ M35-189-11
13 5 M35-189-13
15 6 M35-189-15

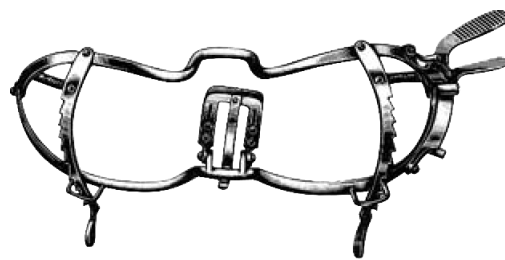

Whitehead
cm in
11 4 ¼ M35-191-11
13 5 M35-191-13
15 6 M35-191-15



M35-193-00
Fig. 0, For children
M35-193-01 M35-193-02 M35-193-03
Fig. 1-2-3 Set
M35-193-13

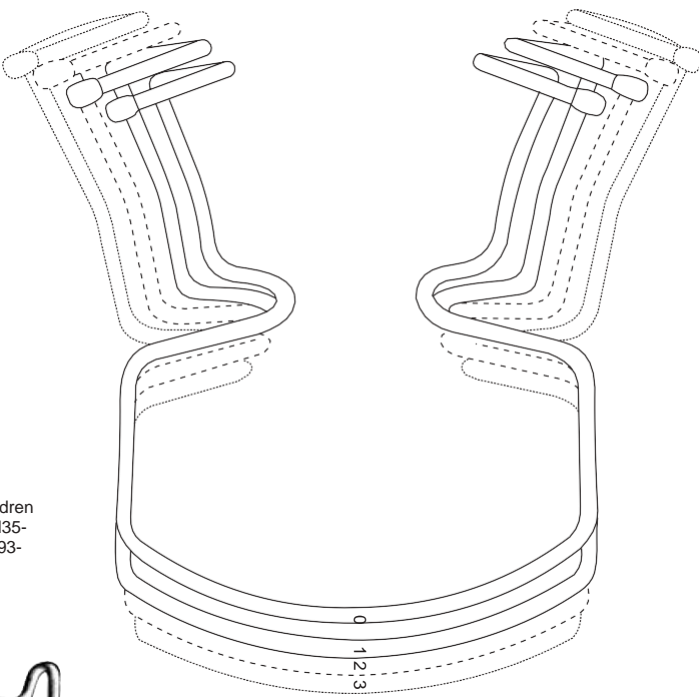

11 cm/4 1/4"
M35-194-11

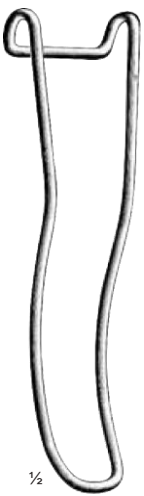

1/2



1/2

Sternberg

	cm	in	
M35-195-12	12	4 3/4	M35-197-12
M35-195-14	14	5 1/2	M35-197-14
M35-195-16	16	6 1/4	M35-197-16

M35-199-12	M35-201-11	Cheek Retractor
M35-199-14	M35-201-12	Lip Retractor
M35-199-16	M35-201-14	Lip Retractor
M35-199-18	M35-201-16	Lip Retractor
M35-199-21	M35-201-18	Lip Retractor
	M35-201-19	Cheek Retractors



19 cm/7 1/2"
M35-203-19



Hartmann
15 cm/6"
M35-205-15

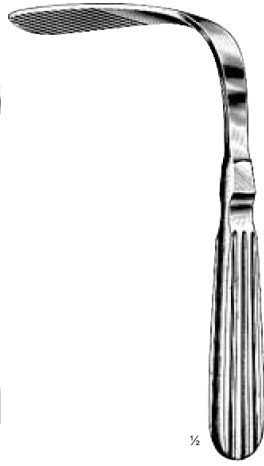

Tobold
14.5 cm / 5½"
M35-207-14

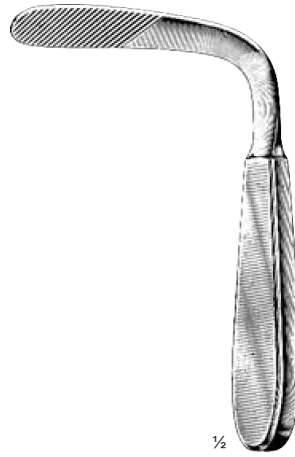

Tobold
14.5 cm/5 ¾"
M35-209-14



Andrew
11 cm/4 ¼"
M35-211-11

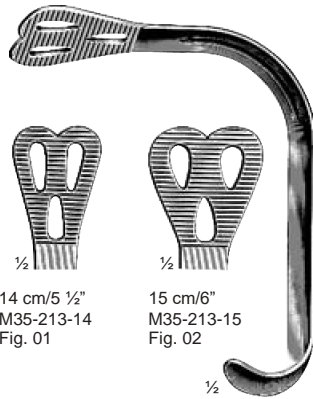

14 cm/5 ½"
M35-213-14
Fig. 01

15 cm/6"
M35-213-15
Fig. 02

Wieder

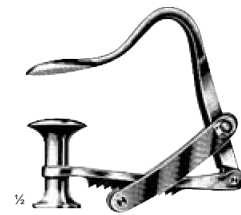

Rottenstein-Schreite
M35-215-00



Doyen
cm in.
13 5 M35-217-13
16 6¼ M35-217-16

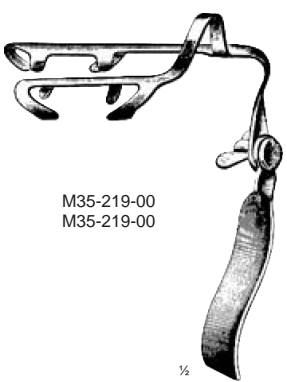

M35-219-00
M35-219-00

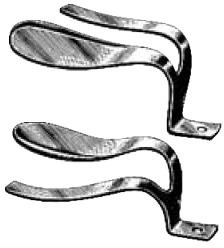

Zuwafix
M35-221-00



Hartmann
M35-223-15
15 cm/6"

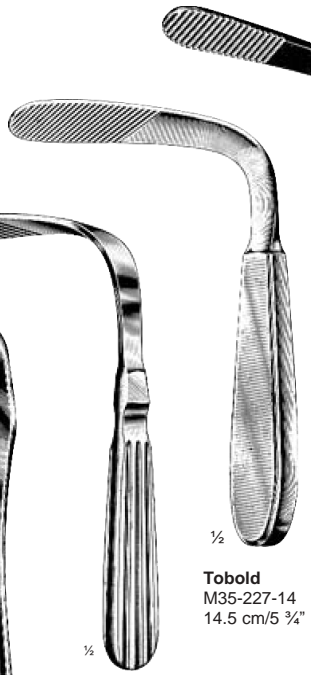

Tobold
M35-227-14
14.5 cm/5 ¾"

Tobold
14.5 cm / 5½"
M35-225-14



Andrew
M35-229-11
11 cm/4 ¼"

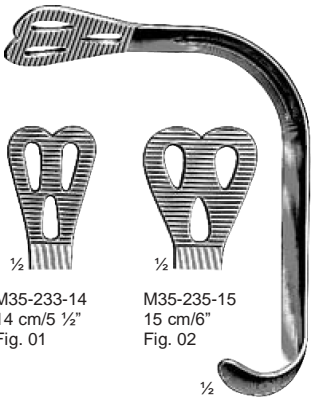

Wieder

M35-233-14
14 cm/5 ½"
Fig. 01

M35-235-15
15 cm/6"
Fig. 02

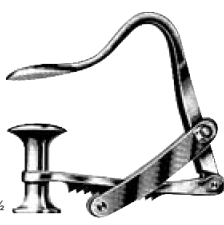

Rottenstein-Schreite
M35-231-00

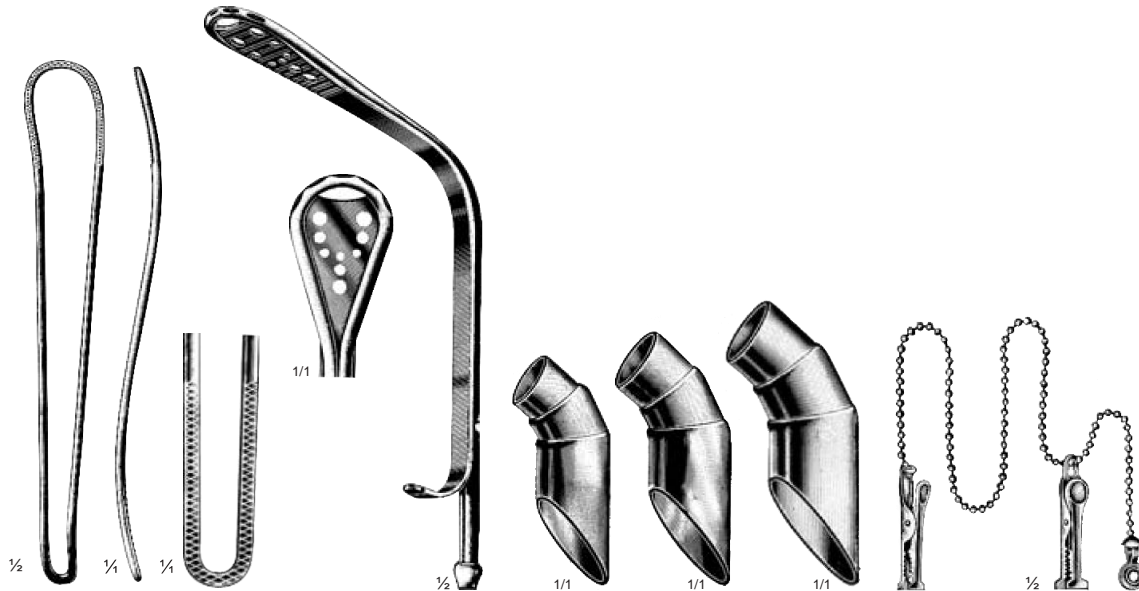

Frenzel
M35-237-16
16.5 cm/6"

Le Mee
M35-239-01

M35-241-01

Langenbeck
M35-243-02

M35-245-03

M35-247-01



Adams
M35-249-01

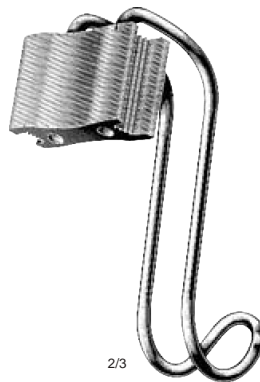

Pitha
M35-251-00

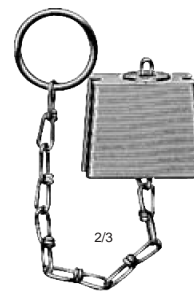

Pitha
M35-253-00



Baisch
M35-255-00

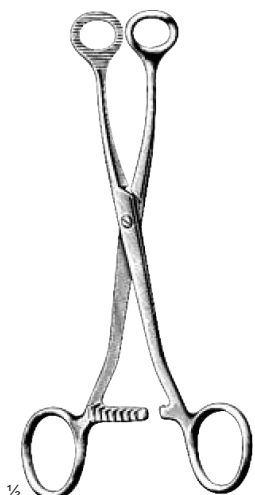

Collin

cm	in	
16	6 ¼	M35-257-16
18	7	M35-257-18

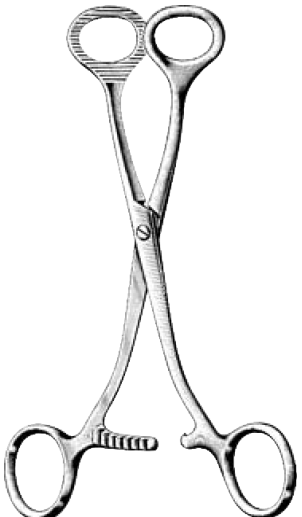

Collin
 M35-259-17
 17 cm / 6 ¾"



Young
 16 cm / 6 ¼"
 M35-261-16



Hartmann
 M35-263-01
 For children / Women



Hartmann
 M35-265-01
 Regular Size



Hartmann
 M35-267-01

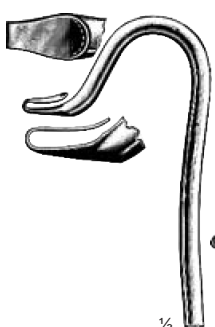

Fluofix

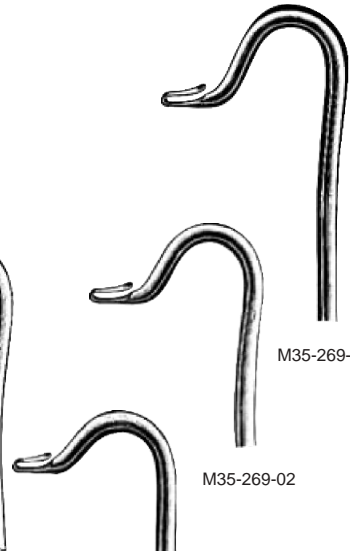

M35-269-01



M35-269-02

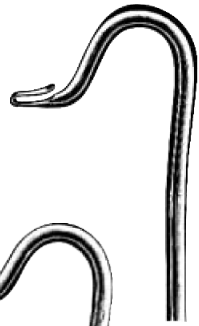

M35-269-03

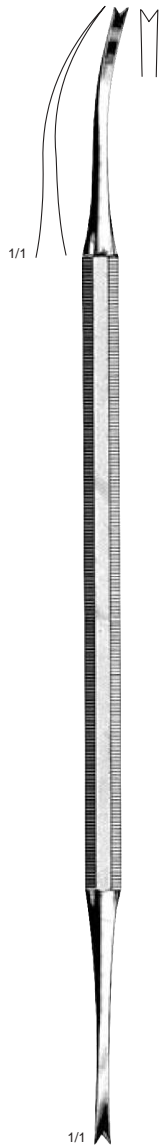

Luniatschek
18.5 cm / 7 1/4"
M35-271-18

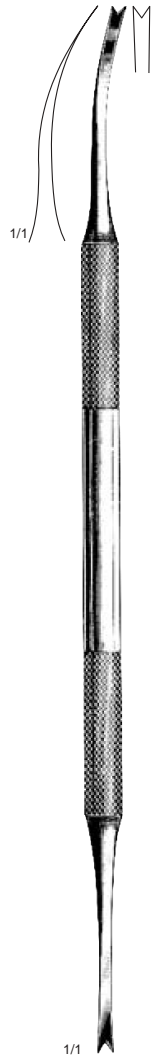

Luniatschek
17 cm / 6 3/4"
M35-273-17

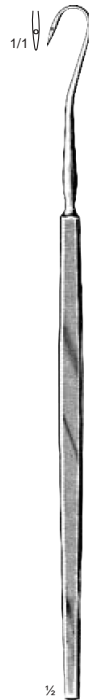

Claus
23 cm / 9"
M35-275-23

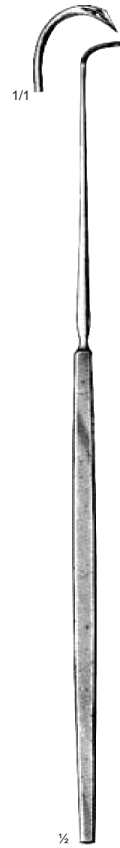

Durham
25 cm / 10"
M35-277-25



Durham
25 cm / 10"
M35-279-25

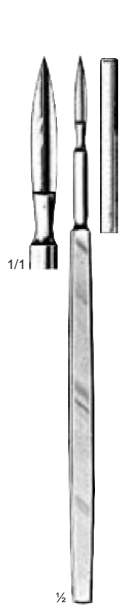

17 cm / 7"
M35-281-17



Brophy
19 cm / 7½"
M35-283-19



Whitehead
19 cm / 7½"
M35-285-19



Whitehead
19 cm / 7½"
M35-287-19

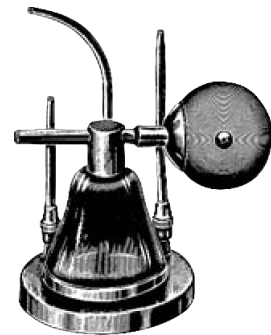

Kabierske
M35-289-00

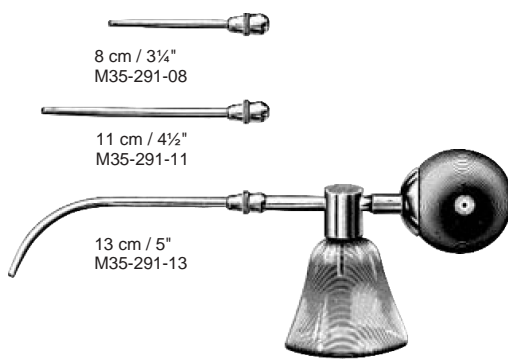

Kabierske
M35-291-00



Halle-Hebderich
M35-293-00

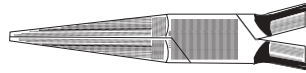

12

Pliers





Lodo
15 cm \ 6"
M36-001-15
Pliers for Removing
Bridges and Crowns.

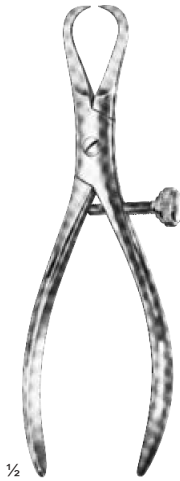

Furrer
15 cm \ 6"
M36-003-15
Copper Ring Removing Pliers



Weingart
14 cm \ 5½"
M36-005-14
Wire Seizing and
Ligature Pliers



15 cm \ 6"
M36-007-15
Wire Seizing and
Ligature Pliers

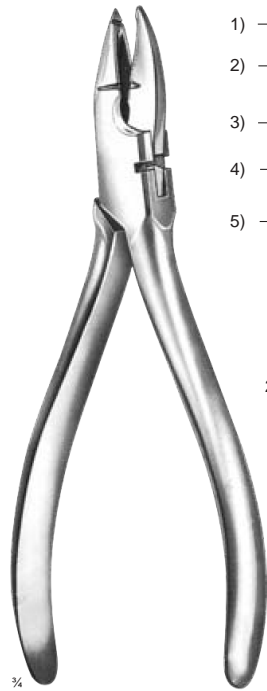

Waldsachs-Universal
15.5 cm \ 6"
M36-009-15
Universal Pliers

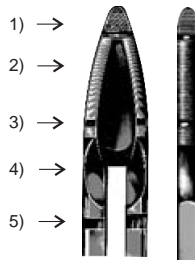

to be used as:
1) Pin and Ligature Pliers
2-3) Clasp Bending Pliers
4) Bar Bending Pliers
5) Cutting Pliers



Universal
15.5 cm \ 6"
M36-011-15
Universal Pin Roughening,
Cutting and Bending Forceps



Universal
15.5 cm \ 6"
M36-011-15



McKellops
16 cm \ 6¼"
M36-013-16

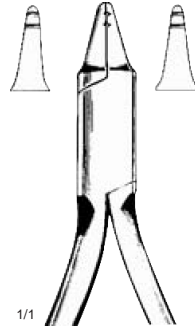

Oliver
12.5 cm \ 5"
M36-015-12



McKellops
17 cm \ 6¾"
M36-017-17

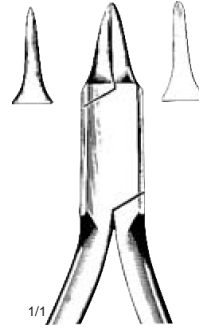

Waldron
12.5 cm \ 5"
M36-019-12

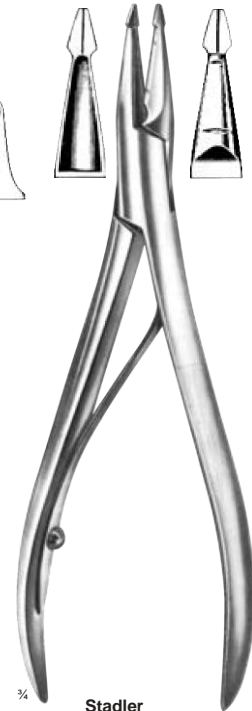

Stadler
15 cm \ 6"
M36-021-15

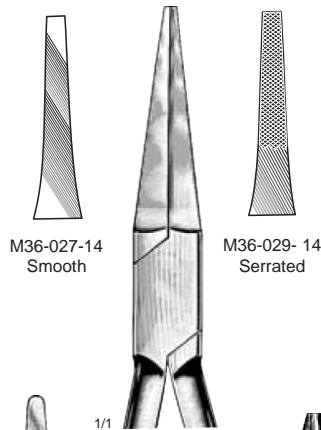
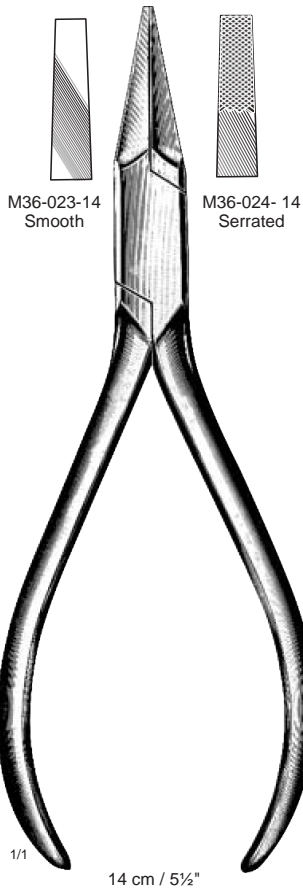

Langenbeck
14 cm / 5½"

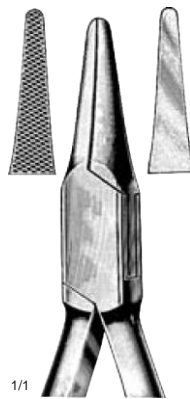

Goslee
14 cm / 5½"
M36-025-14

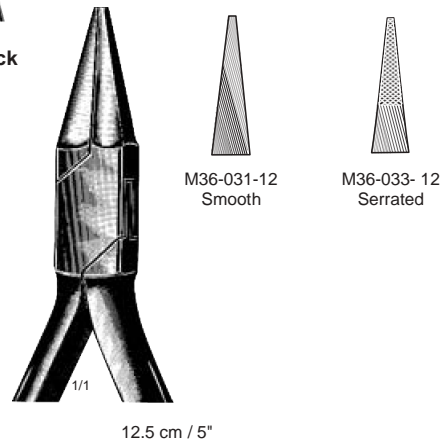

Flat and Nose Pliers End Nippers

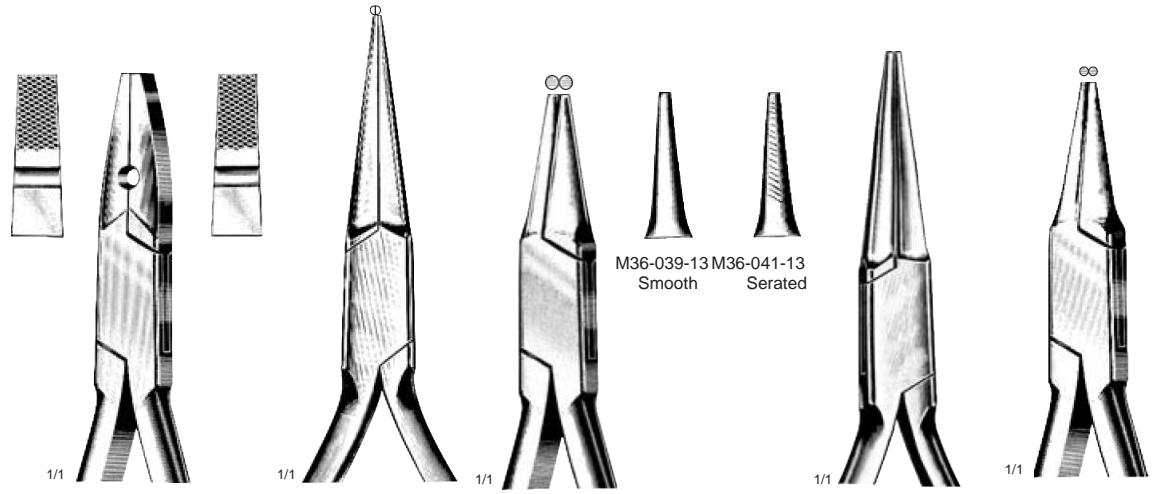

14 cm / 5½"
M36-035-14

Langenbeck
14 cm / 5½"
M36-037-14

13 cm / 5"

Langenbeck
14 cm / 5½"
M36-043-14

13 cm / 5"
M36-045-13



13 cm / 5"
M36-047-13

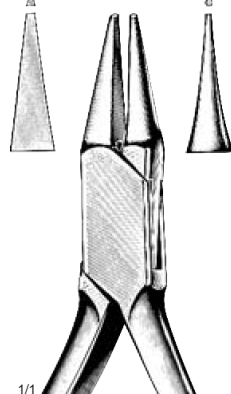

15 cm / 6"
M36-049-15

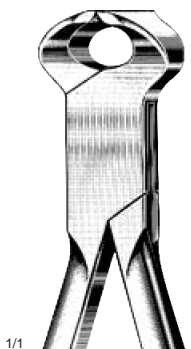

12.5 cm / 5"
M36-051-12



13 cm / 5"
M36-053-13



11 cm / 4½"
M36-055-11



11 cm / 4½"
M36-057-11

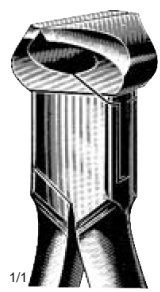

12 cm / 4½"
M36-059-12

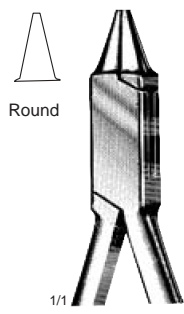

Angle
12 cm / 4¾"
M36-061-12

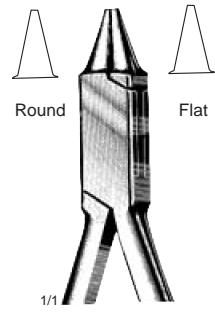

12 cm / 4¾"
M36-063-12



Dumont
11.5 cm / 4½"

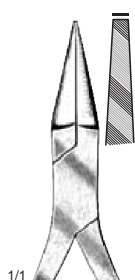

M36-065-11

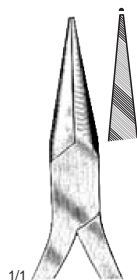

M36-067-11

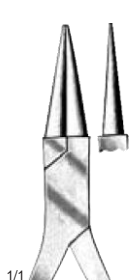

M36-069-11



Dumont
11.5 cm / 4½"



M36-071-11



M36-073-11

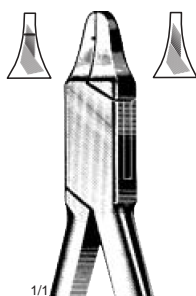

Angle
13 cm / 5"
M36-075-13

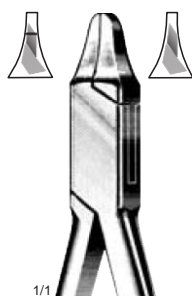

Angle
13 cm / 5"
M36-077-13

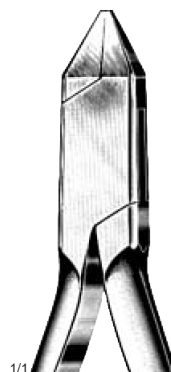

Adams
13 cm / 5"
M36-079-13



Aderer
13 cm / 5"
M36-081-13

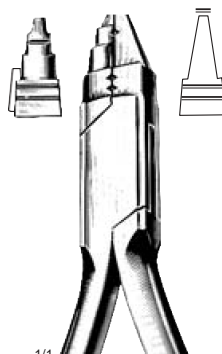

Young
13 cm / 5"
M36-083-13



Aderer
14 cm / 5½"
M36-085-14

Clasp and Arch Bending Pliers, Ligature Pliers

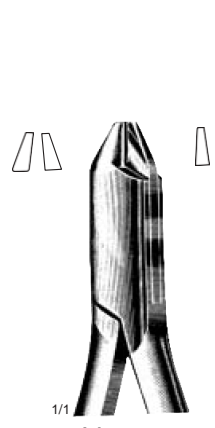

Aderer
11.5 cm / 4½"
M36-087-11

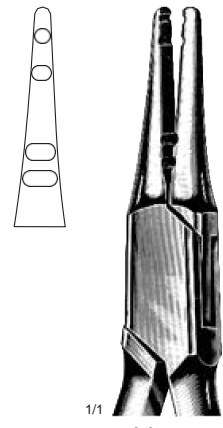

Aderer
14 cm / 5½"
M36-089-14

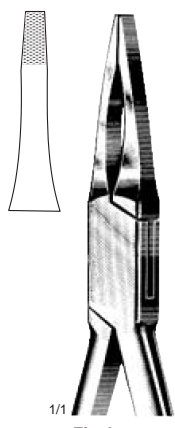
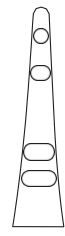

Fischer
13.5 cm / 5¼"
M36-091-13



Diamant
16 cm / 6¼"
M36-093-16

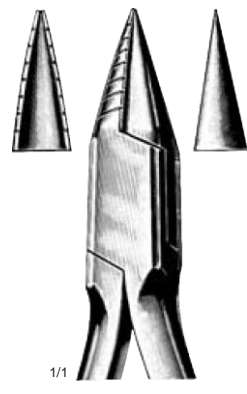

Schwarz
14.5 cm / 5¾"
M36-094-14



Fischer
14 cm / 5½"
M36-095-14

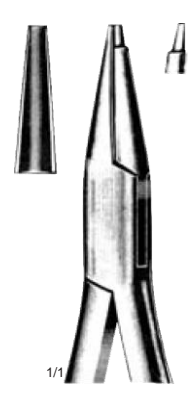

Andresen
14 cm / 5½"
M36-097-14

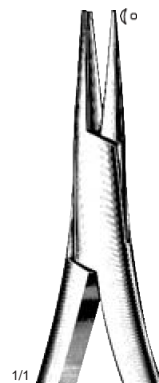

Schwarz
13 cm / 5"
M36-099-13

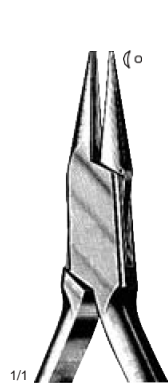

Schwarz
13 cm / 5"
M36-101-13



Schwarz
13 cm / 5"
M36-103-13

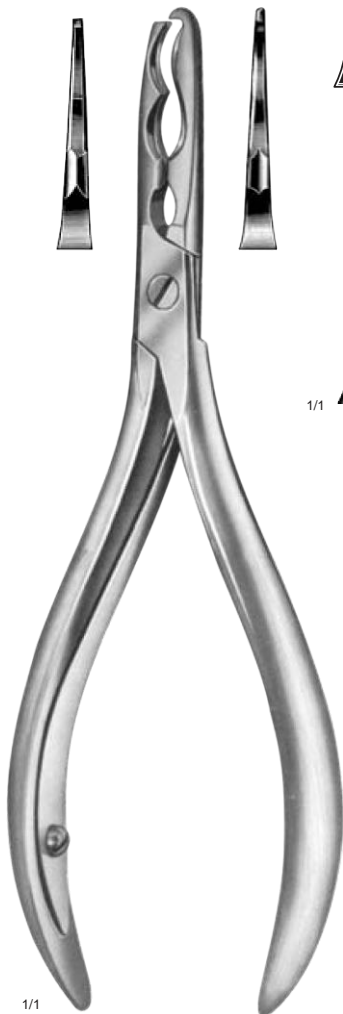

Tryfus
16.5 cm / 6½"
M36-105-16



Peeso
14.5 cm / 5¾"
M36-107-14

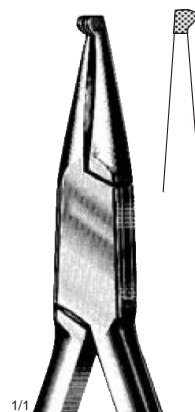

How
14 cm / 5½"
M36-109-14

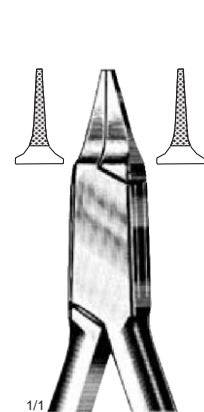

Frevert
12 cm / 4¾"
M36-111-12

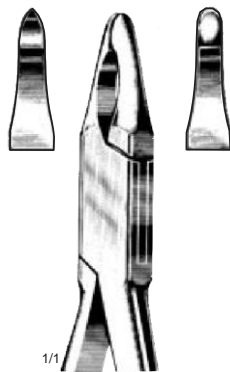

Johnson
13 cm / 5"
M36-113-13

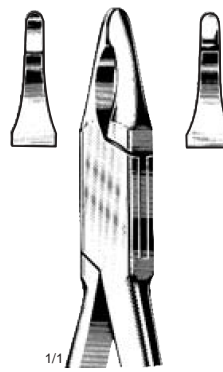

Johnson
13 cm / 5"
M36-115-13

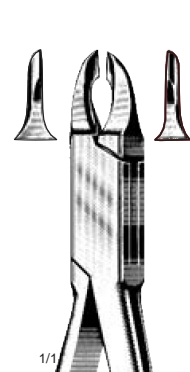

Angle
13 cm / 5"
M36-117-13

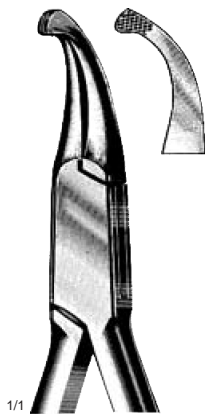

How
14 cm / 5½"
M36-119-14



Ziebe
13 cm / 5"
M36-121-13

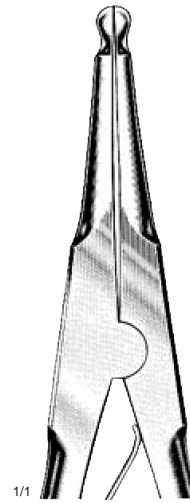

Herbst
14 cm / 5½"
M36-123-14

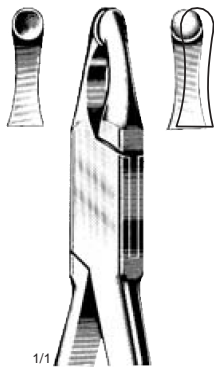

Abell
13 cm / 5"
M36-125-13

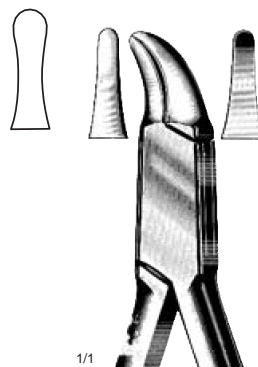

Reynolds
12.5 cm / 5"
M36-127-12

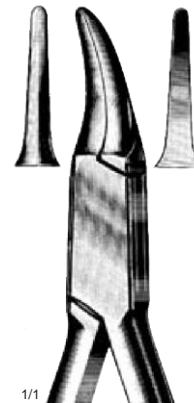

Gordon
14 cm / 5½"
M36-129-14

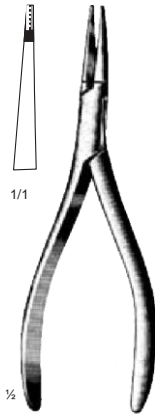

13 cm / 5"
M36-131-13

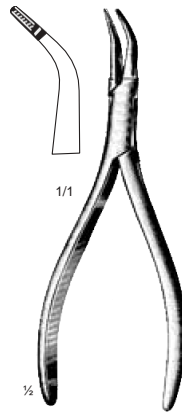

13 cm / 5"
M36-133-13

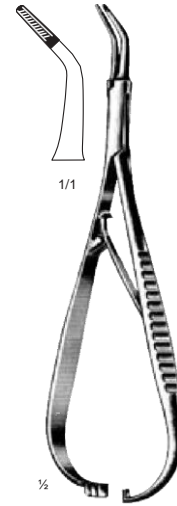

16 cm / 6¼"
M36-135-16

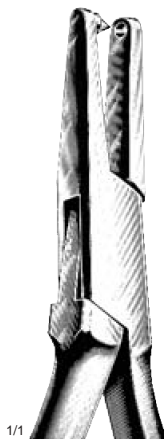

Ainworth
16 cm / 6¼"
M36-137-16

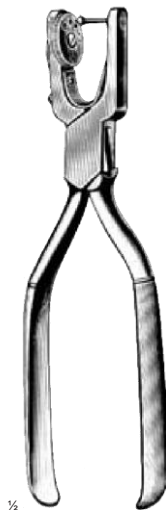

Tuttle
15 cm / 6"
M36-139-15

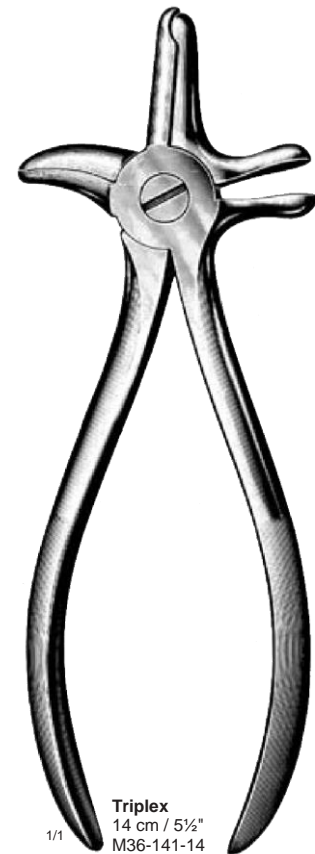

Triplex
14 cm / 5½"
M36-141-14

Copper Ring and Bridge Removing Pliers, Wire Seizing and Ligature Pliers, Universal Pliers



1/2

16 cm/6 1/4" M36-157-16
 18 cm/7" M36-159-18
 23 cm/9" M36-161-23



14 cm/5 1/2" M36-163-14



15 cm/6" M36-165-15



13 cm/5" M36-167-13



13 cm/5 1/2" M36-169-13



13 cm/5 1/2" M36-171-13
 Angled at 15°, with or without spring on the handles.



13 cm/5 1/2" M36-173-13



13 cm/5 1/2" M36-175-13



13 cm/5 1/2" M36-177-13
 Angled at 15°



13 cm/5 1/2" M36-179-13
 Angled at 15°



13 cm/5 1/2"
M36-181-13



13 cm/5 1/2"
M36183-13



15 cm/6"
M36-185-15
Hard wire 0.55x0.64
Long handle



13 cm/5 1/2"
M36-187-13



13 cm/5 1/2"
M36-189-13



Diagonal Wire Cutter
13 cm/5 1/2"
M35-191-13

Parallel Action Wire Cutter
11 cm/4 1/2"
M35-195-11



Parallel Action Wire Cutter
11 cm/4 1/2"
M35-197-11

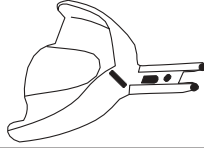

13

Articulators & Impression Trays





M37-001-00



M37-003-00



M37-005-00

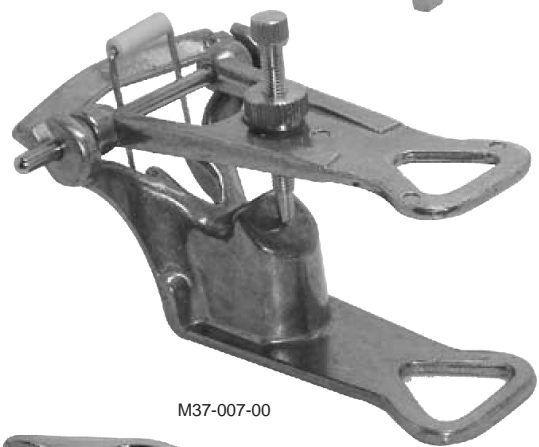

M37-007-00



M37-009-00



M37-011-00



M37-013-00



M37-015-00



M37-017-00

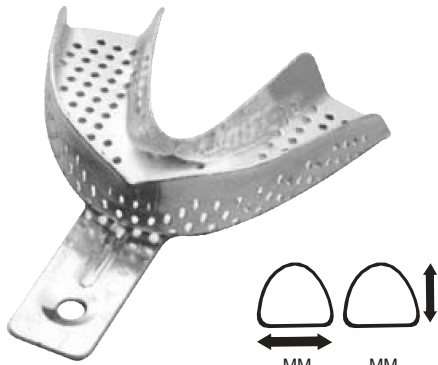

		MM	MM
M37-019-U1	XXS	63	48
M37-019-U2	XS	66	51
M37-019-U3	S	68	54
M37-019-U4	M	71	58
M37-019-U5	L	74	62
M37-019-U6	XL	76	63

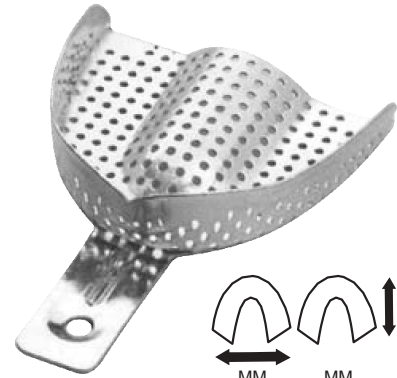

		MM	MM
M37-021-L1	XXS	56	48
M37-021-L2	XS	59	50
M37-021-L3	S	72	52
M37-021-L4	M	76	57
M37-021-L5	L	77	56
M37-021-L6	XL	78	59

Set of Twelve M37-022-12

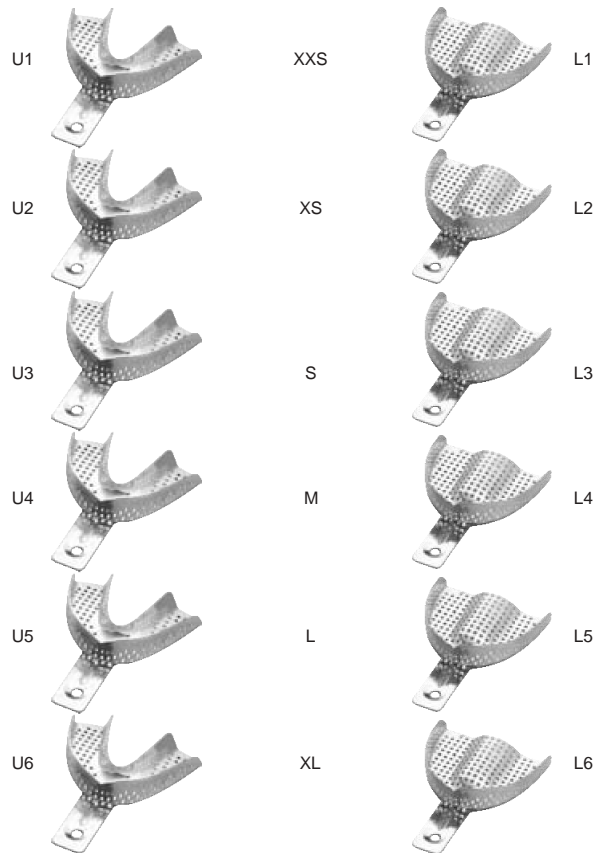

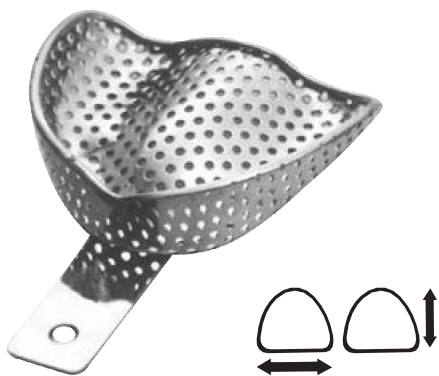

M37-023-U1	L	81	67
M37-023-U4	M	71	64
M37-023-U7	S	70	57



M37-025-L20	L	81	60
M37-025-L21	M	79	57
M37-025-L22	S	76	54

Set of Six M37-027-06

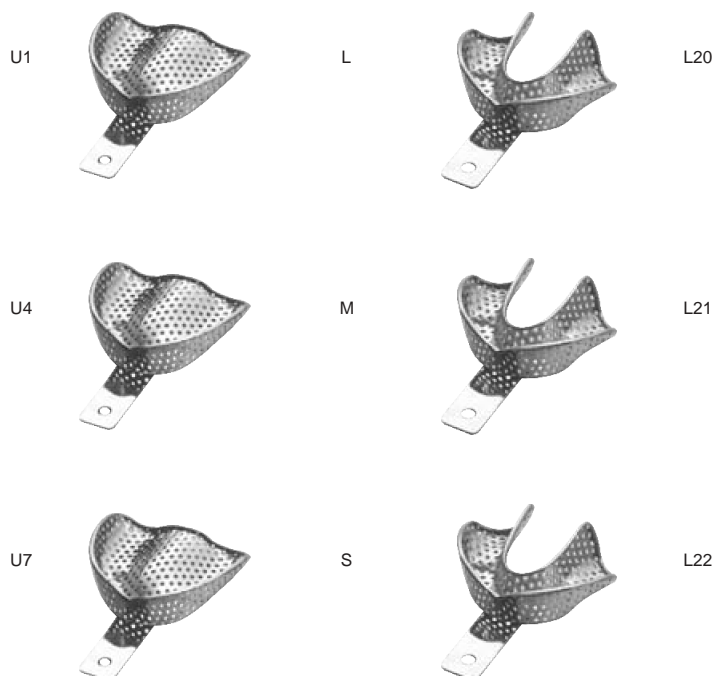

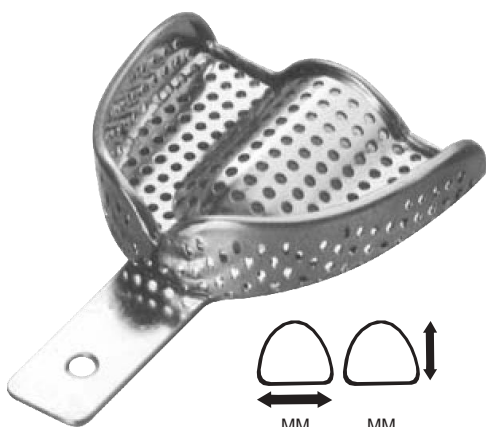

		MM	MM
M37-029-U1	XXS	63	47
M37-029-U2	XS	64	51
M37-029-U3	S	66	53
M37-029-U4	M	69	57
M37-029-U5	L	71	60
M37-029-U6	XL	73	62

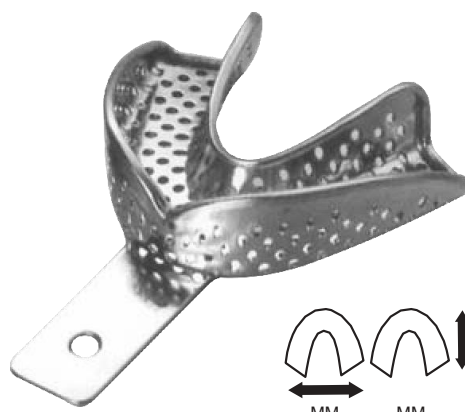

		MM	MM
M37-031-L1	XXS	55	47
M37-031-L2	XS	60	49
M37-031-L3	S	72	54
M37-031-L4	M	74	57
M37-031-L5	L	76	59
M37-031-L6	XL	78	61

Set of Twelve M37-033-12

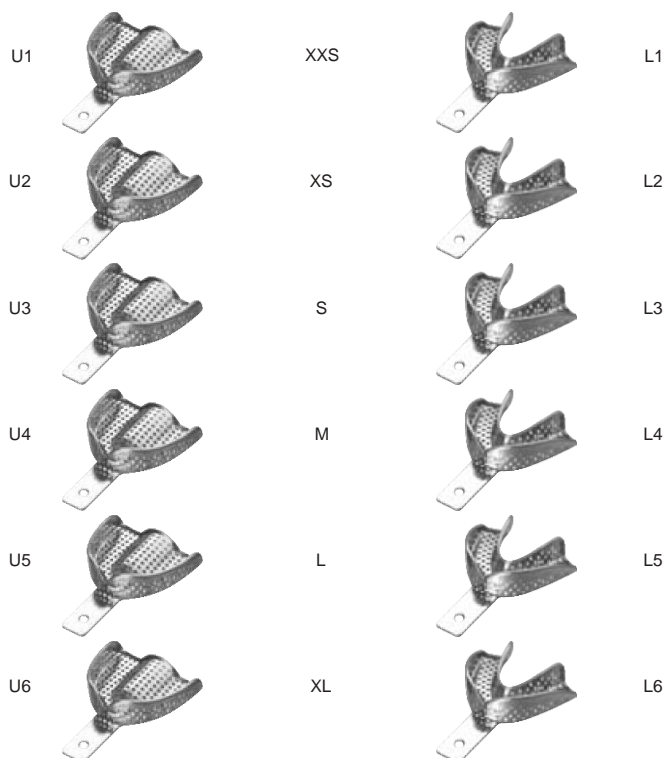

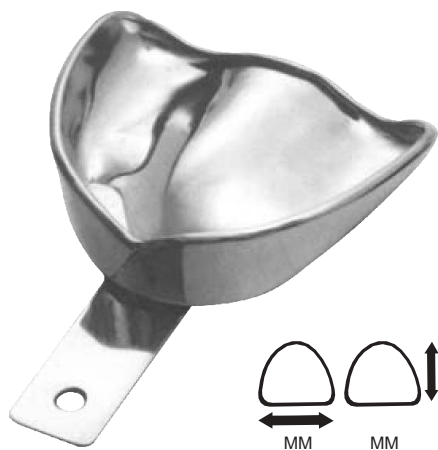

		MM	MM
M37-035-U1	L	81	67
M37-035-U4	M	71	64
M37-035-U7	S	70	57



		MM	MM
M37-037-L20	L	81	60
M37-037-L21	M	79	57
M37-037-L22	S	76	54

Set of Six M37-039-06

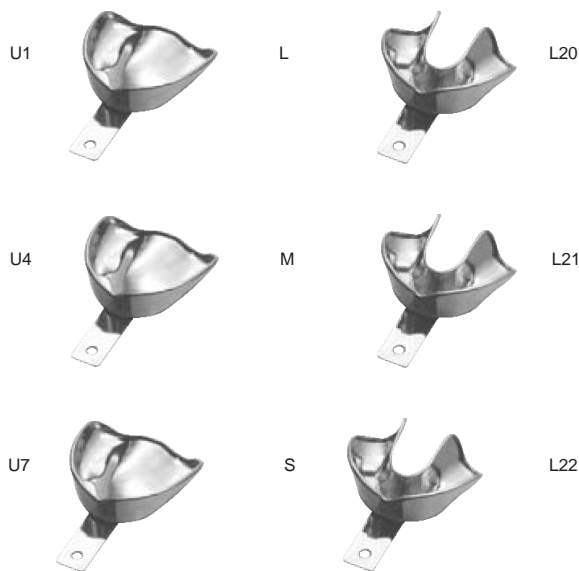

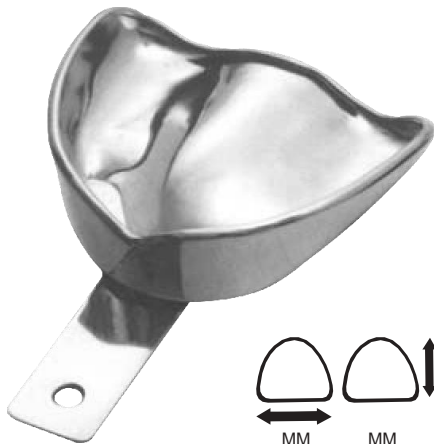

		MM	MM
M37-041-U1	L	81	67
M37-041-U4	M	71	64
M37-041-U7	S	70	57



		MM	MM
M37-043-L20	L	81	60
M37-043-L21	M	79	57
M37-043-L22	S	76	54

Set of Six M37-045-06

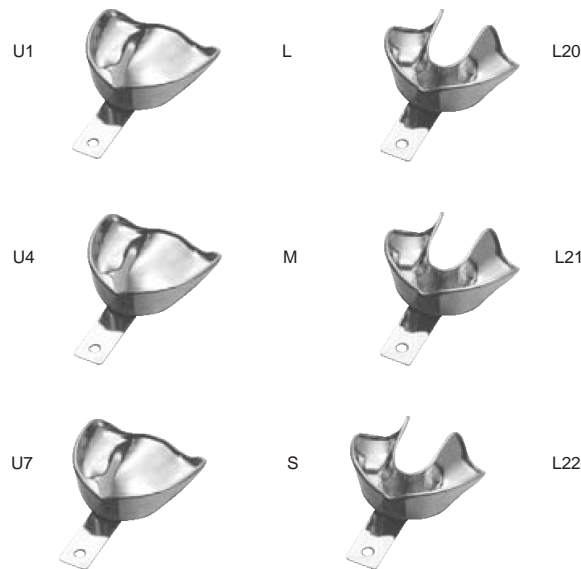



M37-047-U1	XL	73	62
M37-047-U2	L	71	60
M37-047-U3	M	69	57
M37-047-U4	S	66	53
M37-047-U5	XS	64	51
M37-047-U6	XXS	61	47



M37-049-L1	XL	78	61
M37-049-L2	L	76	59
M37-049-L3	M	75	57
M37-049-L4	S	72	54
M37-049-L5	XS	60	49
M37-049-L6	XXS	55	47

Set of Ten M37-051-12

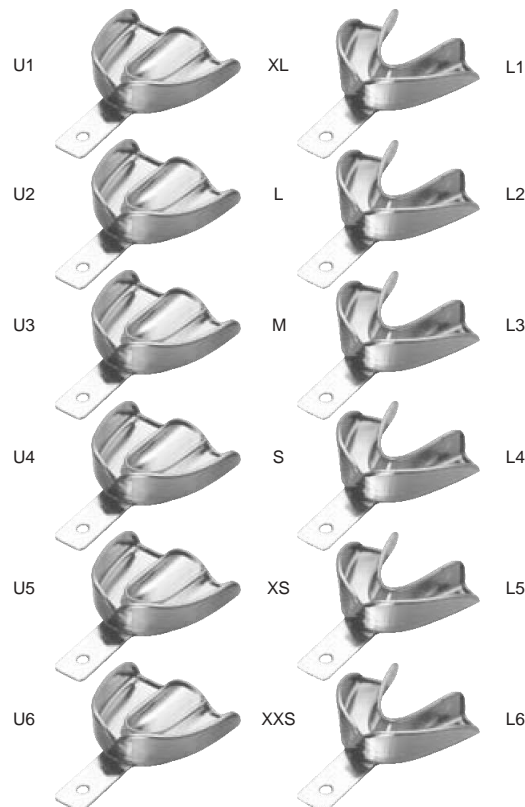



M37-053-U1	XL	81	63
M37-053-U2	L	74	60
M37-053-U3	M	71	55
M37-053-U4	NM	67	53
M37-053-U5	S	65	51



M37-055-L1	XL	80	63
M37-055-L2	L	78	59
M37-055-L3	M	76	57
M37-055-L4	NM	72	57
M37-055-L5	S	69	50

Set of Ten M37-057-10

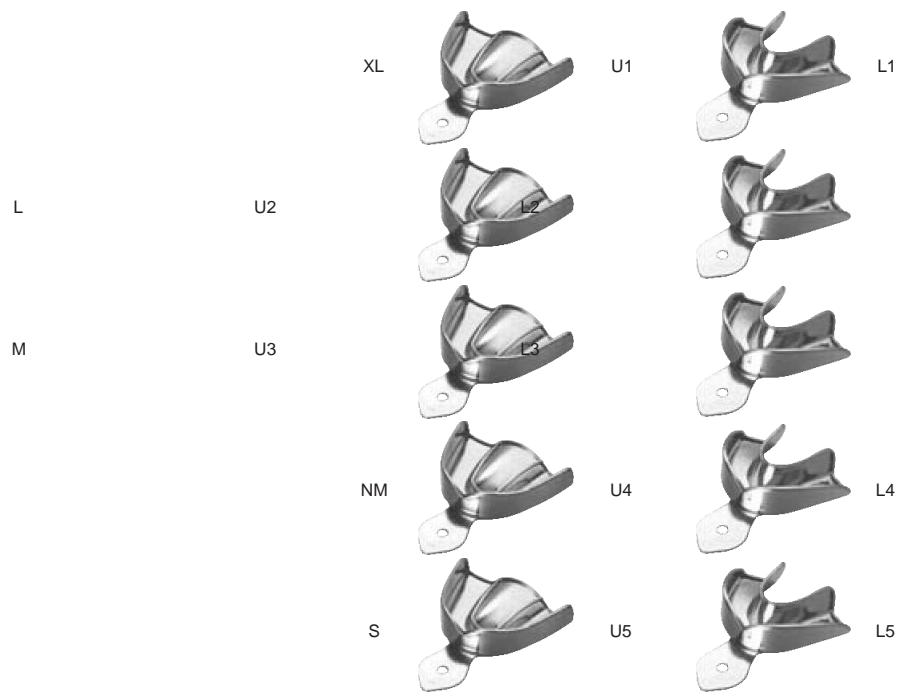



		MM	MM
M37-059-U1	XL	68	62
M37-059-U2	L	75	60
M37-059-U3	M	73	53
M37-059-U4	NM	69	54
M37-059-U5	S	68	52



		MM	MM
M37-061-L1	XL	82	63
M37-061-L2	L	81	61
M37-061-L3	M	78	57
M37-061-L4	NM	74	60
M37-061-L5	S	71	53

Set of Ten M37-063-10

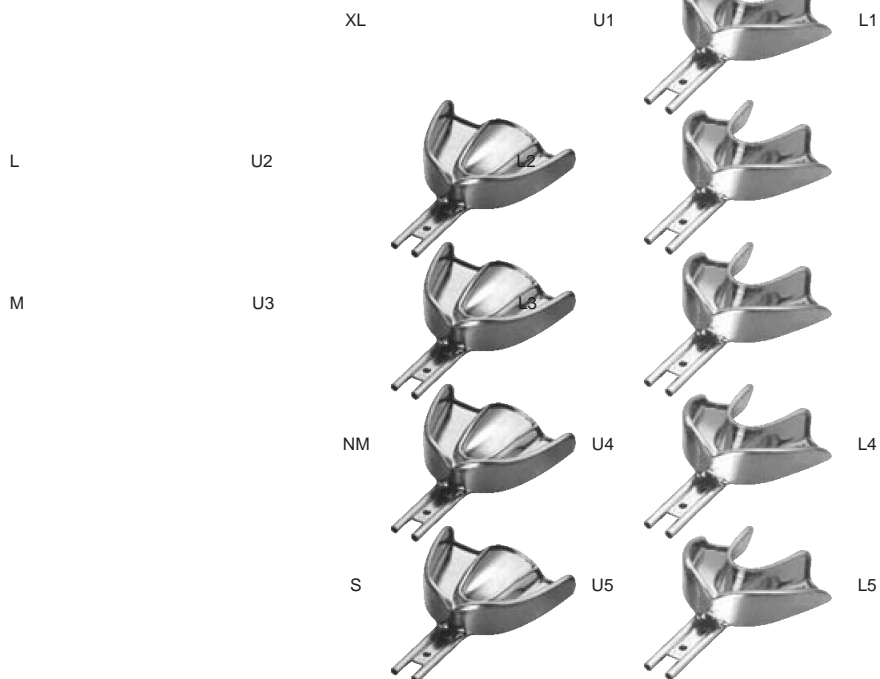



Form C 1/2 R

Form C 1/2 R

fig.	perforated	unperforated
1	M37-065-01	M37-067-11
2	M37-065-02	M37-067-12
3	M37-065-03	M37-067-13
4	M37-065-04	M37-067-14



Form C 1/2 L

Form C 1/2 L

1	M37-069-01	M37-071-11
2	M37-069-02	M37-071-12
3	M37-069-03	M37-071-13
4	M37-069-04	M37-071-14

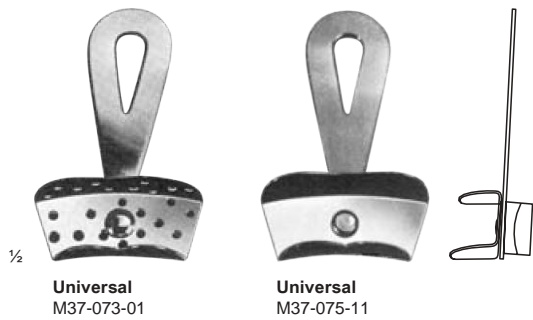

1/2
Universal
M37-073-01

Universal
M37-075-11

with swivel handle and fixing screw

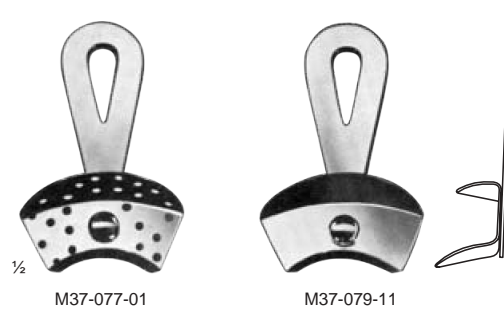

1/2
M37-077-01

M37-079-11

with swivel handle



1/2
Stolley
M37-081-01

Stolley
M37-083-11

1/2
Melotte
M37-085-11

with swivel handle and slide

for crown work

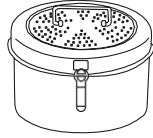

14

STERILIZING BOXES

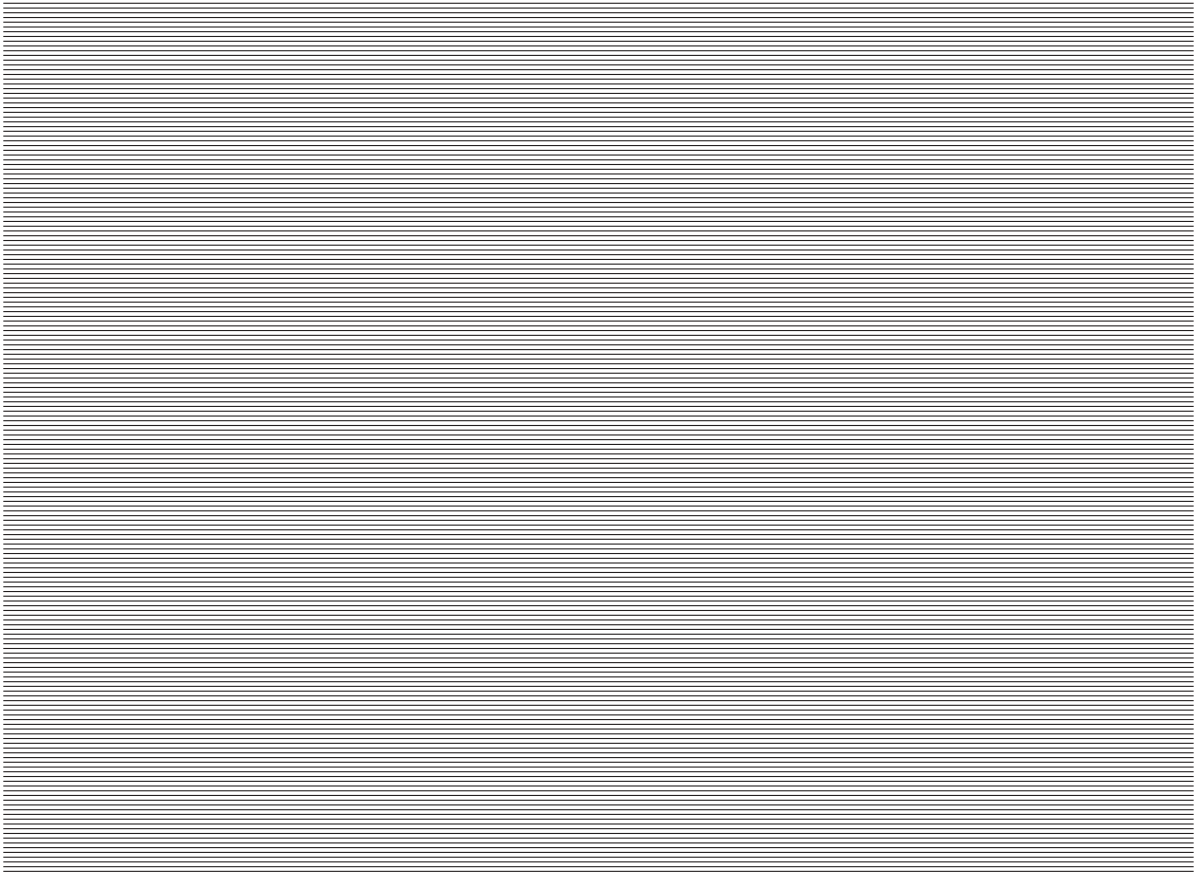

Ø mm	h mm	
80	80	M38-001-01
120	120	M38-001-02
160	120	M38-001-03
160	150	M38-001-04
190	140	M38-001-05
190	200	M38-001-06
240	120	M38-001-07
240	160	M38-001-08
240	240	M38-001-09
290	120	M38-001-10
290	160	M38-001-11
290	240	M38-001-12
340	160	M38-001-13
340	240	M38-001-14
390	145	M38-001-15
390	200	M38-001-16
390	290	M38-001-17



135 mm x 100 x 25 mm
M38-003-25



Proper
78 mmØ x 63 mm
M38-005-63



65 mmØ x 15 mm
M38-007-15



150 mm x 95 X 13 mm
M38-009-13



150 mm x 95 X 13 mm
M38-011-13

M38-001-01	M38-001-17	Dressing Sterilizing Drum
	M38-003-25	Case for Impression Trays
	M38-005-63	Bur-Cleaning and Storing Box
	M38-007-15	Needle Case
M38-009-13	M38-011-13	Boxes and Trays for Burs



150 mm x 95 X 13 mm
M38-013-13



150 mm x 95 X 13 mm
M38-015-13



150 mm x 95 X 13 mm
M38-017-13

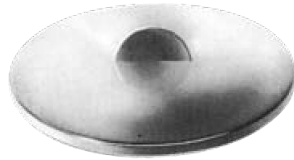

M38-019-13



Ø 110 X 27 mm M38-021-27
Ø 110 x 40 mm M38-023-40



150 mm x 95 X 13 mm
M38-025-13



150 mm x 95 X 13 mm
M38-027-13



Ø X h	Capacity	Satin Finish	Highly Polished
116 x 50	0.35	M38-029-50	M38-031-50
128 x 55	0.45	M38-029-55	M38-031-55
147 x 65	0.7	M38-029-65	M38-031-65
167 x 75	1.1	M38-029-75	M38-031-75
187 x 85	1.6	M38-029-85	M38-031-85

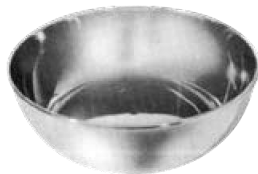

Ø X h	Capacity	Satin Finish	Highly Polished
116 x 35	0.3	M38-033-35	M38-035-35
128 x 38	0.4	M38-033-38	M38-035-38
147 x 40	0.5	M38-033-40	M38-035-40
167 x 45	0.75	M38-033-45	M38-035-45
187 x 45	1.0	M38-033-54	M38-035-54

M38-013-13	M38-027-13	Boxes and Trays for Burs
M38-021-27	AE 21-023-40	Multipurpose Dish
M38-029-50	M38-035-54	Multipurpose Bowls

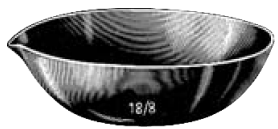

Ø x h	
110 x 128	M38-037-12



Ø	
100	M38-039-10
120	M38-039-12
150	M38-039-15



100 cc
M38-041-01



l x b x h	Satin Finish	Highly Polished
230 x 155 x 30	M38-043-01	M38-045-01
300 x 175 x 30	M38-043-02	M38-045-02
300 x 175 x 40	M38-043-03	M38-045-03
350 x 240 x 36	M38-043-04	
400 x 300 x 50	M38-043-05	



0.5L M38-047-05
1.0L M38-049-10
2.0L M38-051-20



Dish + Lid	100 x 20 mm	M38-053-01
Dish only	96 x 20 mm	M38-055-09
Lid only	100 x 16 mm	M38-057-10

Dish + Lid	100 x 20 mm	M38-059-01
Dish only	96 x 20 mm	M38-061-09
Lid only	100 x 16 mm	M38-063-10





235 x 190 x 40 mm
M38-065-40



Ø 220 x 70 mm
M38-067-70



l x b x h	Satin Finish
210 x 160 x 10	M38-069-01
240 x 180 x 10	M38-069-02
310 x 150 x 10	M38-069-03
310 x 210 x 10	M38-069-04
350 x 240 x 10	M38-069-05
350 x 240 x 20	M38-069-06
400 x 270 x 20	M38-069-07
420 x 280 x 10	M38-069-08



Ø x h	Lid only	Jar without lid
30 x 90	M38-071-01	M38-073-01
50 x 100	M38-071-02	M38-073-02
50 x 130	M38-071-03	M38-073-03
50 x 175	M38-071-04	M38-073-04
75 x 100	M38-071-05	M38-073-05
75 x 130	M38-071-06	M38-073-06
75 x 175	M38-071-07	M38-073-07
100 x 175	M38-071-08	M38-073-08
100 x 200	M38-071-09	M38-073-09



Ø x h	With lid without knob	Lid with knob
75 x 60	M38-075-01	M38-077-01
75 x 75	M38-075-02	M38-077-02
100 x 60	M38-075-03	M38-077-03
100 x 100	M38-075-04	M38-077-04
125 x 80	M38-075-05	M38-077-05
125 x 125	M38-075-06	M38-077-06
135 x 20	M38-075-07	M38-077-07
135 x 35	M38-075-08	M38-077-08
135 x 50	M38-075-09	M38-077-09
135 x 100	M38-075-10	M38-077-10
150 x 100	M38-075-11	M38-077-11
150 x 150	M38-075-12	M38-077-12
200 x 100	M38-075-13	M38-077-13
200 x 150	M38-075-14	M38-077-14
200 x 200	M38-075-15	M38-077-15



205 x 105 x 40 mm
M38-079-40



20 cc
M38-081-20
Medicine Cup



50 cc
M38-083-50
Medicine Cup



25 cc
M38-085-25
Medicine Cup



l x b x h	With lid without knob	Lid with knob
165 x 85 x 35	M38-087-01	M38-089-01
200 x 100 x 35	M38-087-02	M38-089-02
200 x 100 x 50	M38-087-03	M38-089-03
230 x 130 x 50	M38-087-04	M38-089-04
260 x 150 x 50	M38-087-05	M38-089-05
270 x 235 x 50	M38-087-06	M38-089-06
300 x 200 x 50	M38-087-07	M38-089-07
325 x 275 x 30	M38-087-08	M38-089-08



Ø 90 x 90 mm
M38-091-90



Ø 75 x 50 mm
M38-093-75



Ø 75 x 12 mm
M38-095-75



250 x 115 x 15 mm
M38-097-15



250 x 115 x 15 mm
M38-099-25

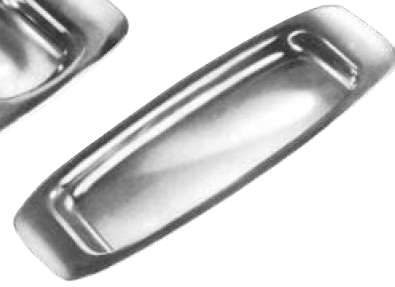

250 x 115 x 15 mm
M38-101-52

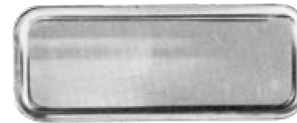
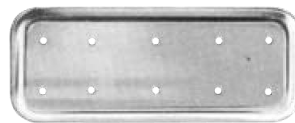

l x b x h	Perforated	Not Perforated
55 x 29 x 6	M38-103-55	M38-105-55
75 x 29 x 6	M38-103-75	M38-105-75
90 x 37 x 6	M38-103-90	M38-105-90

M38-091-90	Tumblers
M38-093-75	Container for Dentures
M38-095-75	Trays for Tablets
M38-097-15	M38-105-90
	Trays



Ø 75 x 80 mm
M38-107-75



Ø 75 x 80 mm
M38-109-75

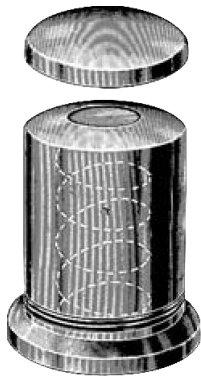

Methot Ø
50 x 75 mm
M38-111-50



Ø 75 x 90 mm M38-113-75
100 x 30 mm M38-113-10



Ø 75 x 90 mm
M38-115-57



I x b x h	Lid only	Bowl only
170 x 100 x 35		M38-119-35
250 x 140 x 40	M38-117-40	M38-119-40
275 x 150 x 45		M38-119-45

M38-107-75	M38-109-75	Sputum Cups
M38-111-75	M38-111-50	Cotton Wool Holders
M38-113-75	M38-113-10	Cotton Wool Dispenser
	M38-115-57	Waste Receptacle
M38-119-35	M38-119-45	Instrument Tray, Kidney Shaped



CONTACT US

Address: FFM9+HX, Ugoke, Sialkot, Punjab 51310

Phone: +92- 304 8000543

E-mail: Info@medicrestsurgical.com

Website: www.medicrestsurgical.com